

VERSICO ROOFING SYSTEMS



VERSICO
ROOFING SYSTEMS

**AIR & VAPOR BARRIER
FIELD GUIDE**



AIR & VAPOR BARRIER FIELD GUIDE

FIELD GUIDE PURPOSE

This manual has been developed to serve as a reference guide for Versico's Authorized Contractors who are already familiar with Versico's roofing systems and are responsible for roof installations.

The following guide contains precautions, best uses, application procedures, accessory information, and common details associated with the installation of Versico's air and vapor barrier (A&VB) systems.

DISCLAIMER

This manual is offered as a supplement, not a substitute to the Specification Manual, Safety Data Sheets, and Technical Data Bulletins.

When installing a Versico warranted system, refer to your roof drawing (stamped and approved by Versico's Project Review & Design Department) for your project's exact requirements.

TABLE OF CONTENTS

Introduction	1
Air & Vapor Barrier – Best Practices	2
VapAir Seal™ 725TR.....	2
VapAir Seal MD.....	2
SureMB 70 SA.....	3
SureMB 90 Base Ply.....	3
SureMB 90TG Base and 120TG Base.....	4
SureMB G2 Base Sheet and SureMB Vented Base Sheet.....	4
Product Breakdown	5
VapAir Seal 725TR.....	5
VapAir Seal MD.....	5
SureMB 70 SA.....	6
SureMB 90.....	6
SureMB 90TG Base and 120TG Base.....	7
Application Procedures	8
Application Procedures for VapAir Seal 725TR Air and Vapor Barrier.....	8
Application Procedures for VapAir Seal MD Air and Vapor Barrier.....	10
Application Procedures for SureMB 70 SA.....	12
Application Procedures for SureMB 90 Base Ply.....	14
Application Procedures for SureMB 90 TG and 120 TG Air & Vapor Barriers.....	16
Air & Vapor Barrier Accessories	19
VapAir Seal 725TR Details	23
TR-0 Installation (Page 1 of 2).....	23
TR-0 Installation (Page 2 of 2).....	24
TR-1.1 Parapet (No Tie-In to Wall Vapor Barrier).....	25
TR-1.2 Roof Edge Roof A&VB Tie-In to Wall A&VB.....	26
TR-1.3 Parapet on Roof Deck Roof A&VB Tie-In to Wall A&VB.....	27
TR-1.4 Parapet (Continuous Wall) A&VB Tie-In to Wall A&VB.....	28
TR-3.1 Expansion Joints.....	29
TR-6.1 Roof Drain with Varying Sump Conditions.....	30
TR-6.2 Roof Drain with Adjustable Height – Type A.....	31
TR-6.3 Roof Drain with Adjustable Height – Type B.....	32
TR-8.1 Pipe Flashing Sealed with VapAir Seal Flashing Foam Per Specifications.....	33
TR-8.2 Pipe Flashing with Quick Applied Uncured Flashing.....	34
TR-8.3 Pipe Flashing Multiple Pipes in Group.....	35
TR-8.6A Hot Vent Stack with Metal Curb at Deck.....	36
TR-8.6B Hot Vent Stack with Wood Curb.....	37
TR-12.1 Tie-In to Upper Story Wall.....	38
TR-15.1A Inside Corner with VapAir Seal 725TR Flashing.....	39
TR-15.1B Inside Corner with Quick Applied Uncured EPDM.....	40
TR-15.2C Outside Corner with Pre-Cut Quick Applied Uncured EPDM (Page 1 of 2).....	41
TR-15.2C Outside Corner with Pre-Cut Quick Applied Uncured EPDM (Page 2 of 2).....	42
VapAir Seal MD Details	43
MD-0 Installation (Page 1 of 2).....	43
MD-0 Installation (Page 2 of 2).....	44
MD-1.1 Parapet (No Tie In to Wall Vapor Barrier).....	45
MD-1.2 Roof Edge: Roof AV&B Tie-In to Wall A&VB.....	46
MD-1.3 Parapet on Roof Deck Roof A&VB Tie-In to Wall A&VB.....	47

MD-1.4 Parapet (Continuous Wall) Roof A&VB Tie-In to Wall A&VB	48
MD-3.1 Roof Expansion Joint (Roof-to-Roof Joint)	49
MD-3.2 Roof Expansion Joint (Roof-to-Wall Joint)	50
MD-6.1 Roof Drain with Varying Sump Conditions	51
MD-6.2 Roof Drain with Adjustable Height – Type A	52
MD-6.3 Roof Drain with Adjustable Height – Type B	53
MD-8.1 Pipe Sealed with VapAir Seal Flashing Foam Per Specifications	54
MD-8.2 Pipe Quick Applied Uncured EPDM Flashings	55
MD-8.3 Multiple Penetrations' Flashings in Group	56
MD-8.4 Pipe Sheet Metal Flanges to Support Flashing	57
MD-8.6A Hot Vent Stack with Metal Curb at Deck	58
MD-8.6B Hot Vent Stack with Wood Curb	59
MD-12.1 Tie-In to Upper Storey Wall	60
MD-15.1A Inside Corner with VapAir Seal MD Piece	61
MD-15.1B Inside Corner Flashing with Quick Applied Uncured EPDM Flashing	62
MD-15.2C Outside Corner with Pre-Cut Quick Applied Uncured EPDM (Page 1 of 2)	63
MD-15.2C Outside Corner with Pre-Cut Quick Applied Uncured EPDM (Page 2 of 2)	64
MD-15.2D Outside Corner with Quick Applied Uncured EPDM Flashing – Option 1	65
MD-15.2E Outside Corner with Quick Applied Uncured EPDM	66
Contact Information	67
Disclaimer	67

SECTION 1: INTRODUCTION

This manual has been developed to serve as a reference guide for Versico's Authorized Contractors who are already familiar with Versico's roofing systems and are responsible for roof installations.

The following guide contain precautions, best uses, application procedures, accessory information, and common details associated with the installation of Versico air and vapor barrier (A&VB) systems.

This manual is offered as a supplement, not a substitute to the Specification Manual, Safety Data Sheets, and Technical Data Bulletins.

When installing a Versico warranted system, refer to your roof drawing (stamped and approved by Versico Project Review & Design Department) for your project's exact requirements.



Top 8 Air and Vapor Barrier Installation Errors

1. **A&VB membrane not kept at proper temperature before installation:** It is critical to keep the temperature of the A&VB membrane above 60°F (15.5°C), as low temperatures can negatively affect adhesion. If the membrane's temperature is below 40°F (4.4°C) during installation, adhesion will be significantly diminished.
2. **Primer not kept at proper temperature before installation:** Primer must be kept above 60°F (15.5°C) prior to installation. CAV-GRIP® 3V Low-VOC Adhesive/Primer is particularly susceptible to cold; if the cylinder drops below 45°F (7°C), the gas propellant will change to a liquid and the cylinder will stop spraying. If this should occur, warm the cylinder above 60°F (15.5°C) and the propellant will return to a gas.
3. **A&VB membrane not properly rolled in:** SBS (Styrene-Butadiene-Styrene) asphalt adhesive is pressure-sensitive. To ensure proper contact, A&VB field sheets must be rolled with a 100- to 150 lb. roller, and vertical surfaces must be rolled with a hand roller. When installing VapAir Seal MD directly over metal decks, brooming the sheet is acceptable.
4. **No primer on parapet:** When installing VapAir Seal MD on vertical and non-metal surfaces, priming is required. When installing VapAir Seal MD directly over metal decks, priming is not required.
5. **Seams not rolled in properly:** To ensure proper adhesion, it is critical that seams are rolled in with a seam roller. Using a 150 lb. roller on seams is not sufficient.
6. **Improper details:** It is critical that A&VBs are properly sealed per Versico specifications and details.
7. **Improper A&VB membrane for project:** Many variables (deck type, weather, job conditions, etc.) determine which type of A&VB to use on a project.
8. **Installing A&VB over wet concrete:** Because adhesion can be compromised when A&VBs are installed over wet concrete, it is critical that the concrete be allowed to dry before installation. The concrete must be allowed to dry naturally; "torch drying" or "force drying" are not acceptable, as these methods push moisture back into the concrete. Additionally, if rain falls on a dry concrete deck, it must be allowed to dry naturally prior to installing A&VB.

SECTION 2: AIR & VAPOR BARRIER – BEST PRACTICES

VapAir Seal 725TR

Best Uses/Advantages: VapAir Seal 725TR serves as an air and vapor barrier and a temporary roof (for up to 120 days). This product is best used over concrete, DensDeck®, or SECUROCK® substrates and features a polypropylene film surface to enhance weathering performance and resistance to foot traffic. When installing the permanent roof system, the poly film surface serves as an excellent substrate for insulation attachment using Flexible DASH™ Adhesive. If insulation is mechanically fastened, VapAir Seal 725TR's self-adhering properties allow it to seal around the fasteners, preventing air and moisture from entering the roofing system.

Coverage	325 FT ² /roll
Thickness	40 mils
Roll size	39" x 100'
Weight	67 lbs/roll
Shelf life	1 year (unopened package)
Product code	330170

Limitations: As with all self-adhering SBS asphalt products, cold temperatures can affect this product's adhesion. When ambient temperatures are below 45°F (21°C), the rolls must be stored at 70°F (7°C) prior to installation.

Although VapAir Seal 725TR seals around mechanical fasteners, the fasteners must remain in place. Puncturing the membrane with a fastener, and then removing it, will create a hole.

VapAir Seal MD

Best Uses/Advantages: VapAir Seal MD is best used directly over metal decks in mechanically fastened systems. This product's reinforced aluminum-coated ply facer offers excellent resistance to construction traffic, and its 12 mils of SBS self-adhering adhesive meets UL 1256 and FM 4450 Class 1 internal fire ratings. Typical roofing installations over metal decks include mechanical attachment of insulation. VapAir Seal MD's self-healing characteristics allow it to seal around fasteners, eliminating or greatly reducing air infiltration into the roofing system. By eliminating air intrusion, this product improves the wind uplift performance of mechanically fastened roof systems. No primer is required on metal substrates prior to adhering the VapAir Seal MD. Uncured EPDM Flashing is compatible with this product's surface film when Versico's V-150 or Low-VOC Primer is used.

Coverage	458 FT ² /roll
Thickness	15 mils
Roll size	42 ½" x 131'
Weight	28 lbs/roll
Shelf life	1 year (unopened package)
Product code	321931

SureMB 70 SA

Best Uses/Advantages: SureMB 70 SA Base Ply serves as an air and vapor barrier and temporary roof (for up to 60 days). It may also be used as a base ply for multiple layer roofing systems. It is best used over concrete, DensDeck, or SECUROCK substrates and features a sanded surface and is reinforced with fiberglass to increase durability for roof traffic. When installing the permanent roof system, the sanded surface serves as an excellent substrate for insulation attachment using Flexible DASH adhesive. If insulation is mechanically fastened, SureMB 70 SA's properties allow it to seal around fasteners, greatly reducing the chance of air and moisture from entering the roofing system.

Coverage	200 FT ² /roll
Thickness	70 mils
Roll size	39 3/8" x 61'
Weight	78 lbs/roll
Shelf life	1 year
Product code	335630

Limitations: As with all self-adhered SBS asphalt products, cold temperatures can affect the product's adhesion. When ambient temperatures are below 45°F (21°C), the rolls must be stored above 60°F (15.5°C) prior to installation. In lower temperatures below 45°F (21°C), light heat (avoid softening) may be applied to the surface of the membrane to enhance initial adhesion.

Although SureMB 70 SA has self-healing properties when penetrated by a fastener, installing a fastener and then removing it will create a permanent hole.

SureMB 90 Base Ply

Best Uses/Advantages: SureMB 90 Base Ply is ideal for use over concrete decks, DensDeck, or SECUROCK. In low temperatures ($\leq 35^{\circ}\text{F}$ [1°C]), SureMB 90 Base Ply can be installed using Type III or Type IV asphalt. Rough, uneven concrete can make it difficult to install self-adhered sheets, but the combination of asphalt and SureMB 90 Base Ply ensures proper adhesion and creates a durable air and vapor barrier and temporary roof (for up to 60 days).

Coverage	150 FT ² /roll (excluding lap)
Thickness	90 mils
Roll size	39 3/8" x 49' 1"
Weight	94 lbs/roll
Shelf life	1 year
Product code	307253

SureMB 90TG Base and 120TG Base

Best Uses/Advantages: SureMB 90TG and 120TG Torch Grade Base Plies offer advantages when installed over concrete decks, since uneven surfaces and moisture caused by dew can create challenges when using self-adhered membranes using Torch-grade membranes eliminate the kettles and odors typically associated with hot asphalt. SureMB 90TG and 120TG are also less sensitive to cold weather conditions than many other products.

SureMB 90TG Base

Coverage	161 FT ² /roll (excluding lap)
Thickness	90 mils
Roll size	39 3/8" x 49' 1"
Weight	95 lbs/roll
Shelf life	1 year
Product code	323887

SureMB 120TG Base

Coverage	100 FT ² /roll (excluding lap)
Thickness	120 mils
Roll size	39 3/8" x 32' 9"
Weight	88 lbs/roll
Shelf life	1 year
Product code	323313

SureMB G2 Base Sheet and SureMB Vented Base Sheet

Best Uses/Advantages: These base sheets are typically used in conjunction with Versico Air and Vapor Barriers. SureMB Vented Base Sheet is ideal for use over lightweight concrete or gypsum decks, as well as decks where moisture is a concern. Adhering to these deck types is not good roofing practice and requires a protective layer prior to adhering subsequent layers. After the G2 Base Sheet or Vented Base Sheet is installed, the air and vapor barrier/temporary roof system should be completed using on the following options: adhered VapAirSeal 725 TR, mop-down SureMB 90 Base Ply, or torch-applied SureMB 90TG or 120TG.

G2 Base Sheet should not be used when residual moisture is present in the deck. In these cases, SureMB Vented Base Sheet should be used to allow moisture to vent through the system.

SureMB G2 Base Sheet

Coverage	Approximately 324 FT ² / roll
Roll size	36" x 108'
Weight	84 lbs/roll
Shelf life	1 year
Product code	318310

SureMB Vented Base Sheet

Coverage	Approximately 100 FT ² / roll
Roll size	36" x 36'
Weight	72 lbs/roll
Shelf life	1 year
Product code	321630

SECTION 3: PRODUCT BREAKDOWN

VapAirSeal 725TR

Direct to Steel	✓
Concrete	✓
DensDeck Prime	✓
SECUROCK	✓
Gyp. Deck	Consult Project Review & Design Dept.
Tectum	✗
FM Rating (Steel Deck)	✗
UL Class 1 (Steel Deck)	✗
Temporary Roof	120 Days
Insulation - Adhered	✓
Insulation - Mech. Fastened	✓

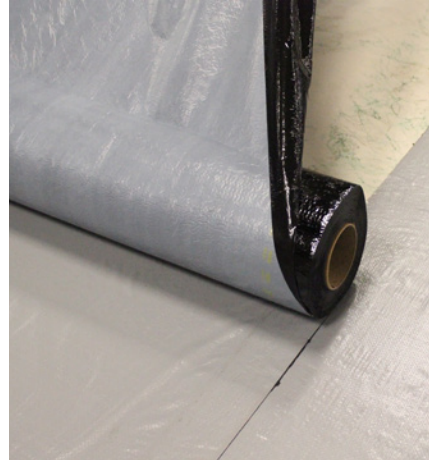

VapAir Seal MD

Direct to Steel	✓
Concrete	✗
DensDeck Prime	✗
SECUROCK	✗
Gyp. Deck	✗
Tectum	✗
FM Rating (Steel Deck)	✓
UL Class 1 (Steel Deck)	✓
Temporary Roof	✗
Insulation - Adhered	✗
Insulation - Mech. Fastened	✓



SureMB 70 SA

Direct to Steel	✓
Concrete	✓
DensDeck Prime	✓
SECUROCK	✓
Gyp. Deck	Consult Project Review & Design Dept.
Tectum	✗
FM Rating (Steel Deck)	✗
UL Class 1 (Steel Deck)	✗
Temporary Roof	60 days (consult project review for longer durations)
Insulation - Adhered	✓
Insulation - Mech. Fastened	✓

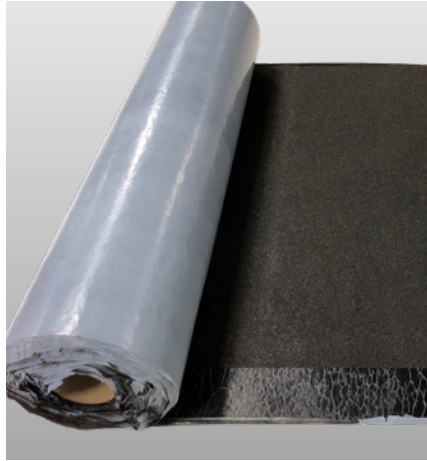

SureMB 90

Direct to Steel	✗
Concrete	✓
DensDeck Prime	✓
SECUROCK	✓
Gyp. Deck	Mech. Attachment
Tectum	Mech. Attachment
FM Rating (Steel Deck)	✗
UL Class 1 (Steel Deck)	✗
Temporary Roof	30 Days
Insulation - Adhered	✓
Insulation - Mech. Fastened	✓



SureMB 90TG & 120TG

Direct to Steel	✘
Concrete	✔
DensDeck Prime	✔
SECUROCK	✔
Gyp. Deck	Mech. Attachment
Tectum	Mech. Attachment
FM Rating (Steel Deck)	✘
UL Class 1 (Steel Deck)	✘
Temporary Roof	30 Days
Insulation - Adhered	✔
Insulation - Mech. Fastened	✔



SECTION 4: APPLICATION PROCEDURES

Application Procedures for VapAir Seal 725TR Air and Vapor Barrier

A. General

1. **VapAir Seal 725TR Air and Vapor Barrier** – A 40-mil-thick composite consisting of a 35-mil self-adhering rubberized asphalt membrane laminated to a 5-mil UV-resistant poly film with an anti-skid surface. Fully compatible with Flexible DASH Adhesive. 725TR can also function as a temporary roof for up to 120 days. Available in rolls 39" x 100' (325 FT² or 30 m²).
2. **CAV-GRIP 3V Low-VOC Adhesive/Primer** – A low-VOC, high-strength contact adhesive used to prime surfaces for the application of 725TR. CAV-GRIP 3V is quick-drying and easy to apply using the self-contained pressurized cylinder and its blend of VOC-exempt and non-exempt solvents complies with the State of California Clean Air Act of 1988 (updated in 1997). Coverage rate is 1,200-1,500 FT² (111-139 m²) per cylinder when used as a primer.
3. **CCW 702 Primer, 702LV Primer (low-VOC), and 702WB Primer (water-based)** – These single-component, solvent-based, high-tack primers provide maximum adhesion between 725TR Air and Vapor Barrier and approved substrates. 702, 702LV, and 702WB are sold in 5-gallon containers and can be applied by spray or by using a long-nap roller; coverage rates range from approximately 300-350 FT² (27-32 m²) per gallon on smooth finishes (e.g., concrete) to 75 FT² (7 m²) per gallon on porous surfaces (e.g. DensDeck Prime). 702LV Primer contains less than 250g/L VOCs and meets the requirement for Ozone Transport Commission (OTC) states and Leadership in Energy and Environmental Design (LEED®) requirements for Volatile Organic Compounds. 702WB Primer is water-based and meets the State of California Clean Air Act of 1988 (updated in 1997).

B. Approved Substrates

VapAir Seal 725TR, in conjunction with either CAV-GRIP 3V or 702 Primers, can be used over structural concrete and wood decks. SECURLOCK and DensDeck Prime (typically used over steel deck construction) are also suitable substrates, provided the coverboards are mechanically fastened to the deck at the minimum rate of 1 fastener per 2 FT² or adhered to the deck with Flexible DASH Adhesive per Versico specifications.

CAUTION: The use of standard DensDeck is not recommended due to excessive primer absorption. When standard DensDeck is specified, two coats of primer are required, as well as a trial test to verify adequate adhesion of the 725TR.

C. Limitations

1. Do not apply primer or vapor barrier to frozen substrates. Best results are obtained when temperatures are above 40°F (4°C).
2. 725TR may be installed in temperatures as low as 10°F (-12°C) based on the following criteria:
 - a. Concrete decks can be a heat sink (releasing heat back into the cold atmosphere), so warming the concrete prior to installation will support optimum adhesion of the 725TR.
 - b. All materials (725TR and primer) must be stored in temperatures above 60°F (15°C) immediately prior to installation.
 - c. For best results, CAV-GRIP 3V will allow for the shortest flash off time (30-45 minutes)

Note: Propellant in CAV-GRIP 3V will revert to a liquid when the cylinder temperature falls below 45°F (7°C). If this occurs, simply warm the cylinder up above 60°F (15°C) and the propellant will revert to a gas.

- d. In temperatures below 40°F (4°C), priming the seams is recommended to ensure seam performance.
3. Do not apply primer or 725TR to damp or contaminated surfaces.
4. 725TR is not recommended for use over sealants that contain coal tar or polysulfide. If these materials are present, they must be removed and the surfaces must be thoroughly cleaned.

D. Installation

1. **Surface Preparation:** Concrete shall be in place for a minimum of seven days and the substrate must be dry. The surface shall have a smooth finish and be free of voids, spalled areas, sharp protrusions, loose aggregate, laitance, and form release agents. In the event of rain, concrete must be allowed to dry before primer is applied.
2. **Primer:** Surfaces to receive 725TR must be clean and dry. Prime with CAV-GRIP 3V, 702, 702LV, or 702WB Primer. Apply primer by spray, brush, or with a long-nap roller at the applicable coverage rates. At 75°F (24°C), allow 702, 702LV, and 702WB Primers to dry for at least one hour. Primer is satisfactorily cured when it will not transfer when touched. Only prime areas where the membrane will be installed the same day. At 75°F (24°C), allow CAV-GRIP 3V to dry for a minimum of 20-30 minutes. Re-prime if area becomes dirty.
3. **Application:** Apply 725TR from low to high point in a shingle fashion so that laps will shed water. Overlap all edges at least 2" (5 cm). End laps shall be staggered. Seams and end laps must be rolled with a 2" (5 cm) seam roller. Place membrane carefully to avoid wrinkles and fishmouths. Immediately after installation, roll with a 150-lb weighted steel roller. When 725TR is used as a temporary roof, the following procedure should be performed:
 - a. Apply a bead of Universal Single-Ply Sealant at the interior of all T-Joint intersections. Refer to applicable Versico detail.
4. **Repairs:** Refer to detail: TR-0 C. Inspect 725TR membrane for tears, punctures, fishmouths, air bubbles, and voids due to misalignment at seams. Remove damaged membrane. Prime exposed substrate and allow primer to dry. Apply a new section of 725TR to primed substrate, extending onto adhered membrane 6" (15.2 cm) on all sides. Firmly press 725TR repair section to ensure a good seal. Slit fishmouths and overlap the edges. Place a section of 725TR over the repair and extend 6" (15.2 cm) in all directions. Firmly press repair section to ensure a good seal.
5. **Insulation Installation:** Ensure that the 725TR surface is dry prior to installing insulation. Place insulation over the surface and mechanically fasten to the roof deck or adhere to the vapor barrier with Flexible DASH Adhesive in accordance with Versico specifications.
6. **Installation at Angle Changes:** To ensure proper installation, the vertical wall must be clean of debris and residual asphalt. Prime the vertical surface, ensuring the primer extends at least 2" (5 cm) up the vertical wall. After installing the 725TR, use a seam roller on the vertical surface to ensure contact with the wall. There are two options for applying 725TR to the vertical surface:
 - a. Option 1: Apply the 725TR up the vertical surface to the height of the insulation, or a minimum of 2" (5 cm).
 - b. Option 2: Apply the 725TR over the entire vertical surface, ensuring the membrane extends over the top of the vertical surface and ties into exterior wall air barrier when applicable. Refer to applicable Versico details.

Note: When utilizing Option 2, mechanically fasten ½" (13 mm) SecurShield® HD, ½" (13 mm) DensDeck, ½" (13 mm) SECUROCK, or ½" (13 mm) plywood over the 725TR surface to ensure a solid substrate to adhere the roofing membrane.

7. **Angle Change Securement Detail G-08:** For VersiFleece® Systems where insulation is adhered to the vapor barrier or adhered roofing systems with base securement into a vertical wall and adhered insulation, one of the following options must be incorporated to ensure that a continuous seal is provided during climatic changes, especially in northern regions:
 - a. Option 1: Mechanically secure the first course of insulation (bottom layer) with insulation fasteners and plates. A row of fasteners shall be installed within 6" (15.2 cm) of the angle change, spaced 12" (30.5 cm) o.c.
 - b. Option 2: In lieu of fastening, install a 3" (7.6 cm)-diameter backer rod along the angle change to accommodate for movement and prevent the effect of the vapor barrier pulling away from angle change.

Note: Maintain Mylar backing at the sponge tubing to prevent the 725TR from adhering to the tubing. Refer to the applicable Versico detail: TR-3.1.
 - c. Option 3: In lieu of fastening and when the use of backer rod is not possible, the 725TR can be installed with a double fold, allowing extra material to accommodate for structural movement.

Note: Maintain Mylar backing within the fold to allow for material expansion in the event of movement. Refer to applicable Versico detail.
8. **Details:** Proper details ensure the integrity of the Air and Vapor Barrier/Temporary Roof. Details must be completed using the following materials: 725TR, Quick-Applied Uncured EPDM Flashing, and VapAir Seal Flashing Foam. Refer to applicable Versico details for penetrations and tie-ins.

Application Procedures for VapAir Seal MD Air and Vapor Barrier

A. General

1. **VapAir Seal MD Air and Vapor Barrier** – A 16-mil-thick composite consisting of an 11-mil self-adhering rubberized asphalt membrane laminated to a 5-mil reinforced aluminum film. VapAir Seal MD can be installed directly to metal decking and is available in rolls 42.5" x 131.23' (464.8 FT² or 43 m²).
2. **CAV-GRIP 3V Low-VOC Adhesive/Primer** – A low-VOC, high-strength contact adhesive used to prime surfaces for the application of VapAir Seal MD. CAV-GRIP 3V is quick-drying and easy to apply using the self-contained pressurized cylinder. CAV-GRIP 3V's blend of VOC-exempt and non-exempt solvents complies with the State of California Clean Air Act of 1988 (updated in 1997). Coverage rate is 1,200-1,500 FT² (111-139 m²) per cylinder.
3. **CCW 702 Primer, 702LV Primer (low-VOC), and 702WB Primer (water-based)** – These single-component, solvent-based, high-tack primers provide maximum adhesion between VapAir Seal MD and approved substrates. 702, 702LV, and 702WB are sold in 5-gallon containers and can be applied by spray or using a long-nap roller; coverage rates range from approximately 300-350 FT² (27-32 m²) per gallon on smooth finishes (e.g., concrete) to 75 FT² (7 m²) per gallon on porous surfaces (e.g., DensDeck Prime). 702LV Primer contains less than 250g/L VOCs and meets the requirement for OTC states and LEED requirements for Volatile Organic Compounds. 702WB Primer is water-based and meets the State of California Clean Air Act of 1988 (updated in 1997).

B. Approved Substrates

VapAir Seal MD Air and Vapor Barrier may be adhered directly to a metal deck without primer. When applying MD to vertical substrates such as plywood, concrete, or another approved substrate, 702, 702LV, CAV-GRIP 3V, or 702WB primer must be applied to the substrate prior to installing the MD membrane.

CAUTION: Use of standard DensDeck is not recommended due to excessive primer absorption. When the use of standard DensDeck is specified, two coats of primer will be required along with a trial test to verify adequate adhesion of the VapAir Seal MD Air and Vapor Barrier.

C. Limitations

1. Do not apply primer or vapor barrier to frozen substrates. Best results are obtained when temperatures are above 40°F (4°C).
2. MD may be installed in temperatures as low as 10° F (-12°C) based on the following criteria:
 - a. All materials (MD and primer) must be stored in temperatures above 60°F (15°C) prior to installation.
 - b. For best results, CAV-GRIP 3V Low-VOC Adhesive/Primer should be applied to the metal deck to ensure proper adhesion during the roofing installation. CAV-GRIP 3V will allow for the shortest flash-off time (15-30 minutes). **Note: The propellant in CAV-GRIP 3V will revert to a liquid when the cylinder temperature falls below 45°F (7°C). If this occurs, simply warm the cylinder up above 60°F (15°C) and the propellant will revert to a gas.**
 - c. In temperatures below 40°F (4°C), priming the seams is recommended to ensure seam performance.
3. Do not apply primer or vapor barrier to damp or contaminated surfaces.
4. VapAir Seal MD is not recommended for use over sealants containing coal tar or polysulfide. If these materials are present, they must be removed and the surfaces must be thoroughly cleaned.

D. Installation

1. **Surface Preparation:** The surface shall have a smooth finish and be free of voids, spalled areas, sharp protrusions, loose aggregate, laitance, and form release agents. In the event of rain, the substrate must be allowed to dry.
2. **Primer:** Non-metal surfaces to receive VapAir Seal MD must be clean and dry. Prime with CAV-GRIP 3V, 702, 702LV (low VOC), or 702WB (water-based) Primer. Apply primer by spray, brush, or with a long-nap roller at the applicable coverage rates. At 75°F (23°C), allow 702, 702LV, and 702WB primer to dry for a minimum of one hour. Primer has a satisfactory cure when it will not transfer when touched. Prime only areas to be waterproofed the same day. At 75°F (23°C), allow CAV-GRIP 3V primer to dry for at least 15-20 minutes. Re-prime if area becomes dirty.
3. **Application:** Apply VapAir Seal MD to the metal deck from low to high point, in a shingle fashion, so that laps will shed water. Overlap all edges at least 2" (5 cm). End laps shall be staggered and either a 6" (15.22 cm)-wide, 24-gauge piece of sheet metal or a 6" (15.2 cm)-wide piece of VapAir Seal MD must be placed directly on the metal underneath and perpendicular to the end lap to ensure a solid surface to roll the end lap together. Seams and end laps must be rolled with a 2" (5 cm) seam roller. Place membrane carefully to avoid wrinkles and fishmouths. Immediately after installation, broom the sheet to ensure proper contact to the metal.
 - a. Apply a bead of Universal Single-Ply Sealant at the interior of all T-Joint intersections. Refer to applicable Versico detail: MD-0.
4. **Repairs:** Following application, inspect VapAirSeal MD membrane for tears, punctures, fish mouths, air bubbles, and voids due to misalignment at seams. Remove damaged membrane and slit any fish mouths. Prime exposed substrate and allow primer to dry. Apply a new section of VapAir Seal MD to primed substrate, extending onto adhered membrane 6" (15.2 cm) on all sides. Roll MD repair section with a seam roller to ensure a good seal.

5. **Insulation:** Ensure surface of VapAir Seal MD Air and Vapor Barrier is dry prior to installing insulation. Place insulation over the surface and mechanically fasten to the roof deck in accordance with Versico specifications.
6. **Installation at Angle Changes:** VapAir Seal MD should be applied to the vertical surface at a 90-degree angle and be adhered to a firm substrate. When a gap is present between the metal deck and the vertical surface, loose-lay a 6" (15.2 cm)-wide 24-gauge piece of sheet metal at the angle change to ensure a solid surface for adhering the membrane. When the gap between the metal deck and vertical substrate is greater than 2" (5 cm), install a piece of insulation to fill in the gap prior to loose-laying the sheet metal.
8. **Details:** VapAir Seal MD should be applied to the vertical surface at a 90-degree angle and be adhered to a firm substrate. When a gap is present between the metal deck and the vertical surface, loose-lay a 6" (15.2 cm)-wide 24-gauge piece of sheet metal at the angle change to ensure a solid surface for adhering the membrane. When the gap between the metal deck and vertical substrate is greater than 2" (5 cm), install a piece of insulation to fill in the gap prior to loose-laying the sheet metal.

Application Procedures for SureMB 70 SA

A. General

1. **SureMB 70 SA Base Ply** – a 70 mil-thick sanded surface self-adhering base ply reinforce with fiberglass. Fully compatible with Flexible DASH Adhesive. SureMB 70 SA can function as an air and vapor barrier, temporary roof for up to 60 days and a base ply for a multiple ply roof system. Available in rolls 39- $\frac{3}{8}$ " x 61' rolls (200 FT² or 18.58 m²)
2. **CAV GRIP 3V Low-VOC Adhesive/Primer** – A low-VOC, high strength contact adhesive used to prime surfaces for the application of SureMB 70 SA. CAV GRIP 3V is quick-drying and easy to apply using the self-contained pressurized cylinder and its blend of VOC-exempt and non-exempt solvents complies with the State of California Clean Air Act of 1988 (updated in 1997). Coverage rate when using it as a primer is 2000 - 2500 FT² (186 – 232 m²) per 40# cylinder.
3. **CCW 702 Primer, 702LV Primer (Low VOC) and 702WB Primer (water-based)** – These single-component, high-tack primers provide maximum adhesion between the SureMB 70 SA and the approved substrate. 702, 702LV, and 702WB are sold in 5-gallon containers and can be applied by spray or by using a long-nap roller: coverage rates range from approximately 300-350 FT² (27-32 m²) per gallon on smooth surfaces (e.g., concrete) to 75 FT² (7 m²) per gallon on porous surfaces (e.g., DensDeck Prime). 702 LV contains less than 250g/L VOCs and meets the requirement for Ozone Transport Commission (OTC) states and Leadership in Energy and Environmental Design (LEED) requirements for Volatile Organic Compounds. 702WB Primer is water-based and meets the State of California Clean Air Act of 1988 (updated in 1997).

B. Approved Substrates

SureMB 70 SA, in conjunction with either CAV GRIP 3V or 702 primers, can be used over structural concrete and wood decks. SECUROCK and DensDeck Prime (typically used over steel deck construction) are also suitable substrates, provided the boards are mechanically fastened to the deck at a minimum of 1 fastener per 2 FT² or adhered to the deck with Flexible DASH Adhesive per Versico Specifications.

CAUTION: The use of standard DensDeck is not recommended due to the excessive primer absorption. When standard DensDeck is specified, two coats of primer are required, as well as a trial test to verify adequate adhesion of the SureMB 70 SA.

C. Limitations

1. Do not apply primer or vapor barrier to frozen substrates. Best results are obtained when temperatures are above 45°F (7°C).

2. SureMB 70 SA may be installed in temperatures as low as 20°F (-6°C) based on the following criteria:
 - a. Concrete decks can be a heat sink (releasing heat back to the cold atmosphere), so warming the concrete prior to installation will support optimum adhesion.
 - b. All materials (SureMB 70 SA and Primer) must be stored in temperatures above 60°F (15°C) immediately prior to installation.

Note: To assist optimum adhesion, applying heat to the surface of the 70 SA will help activate the adhesive.
 - c. For best results, CAV GRIP 3V will allow for shortest flash off time (30-45 minutes).

Note: Propellant in CAV GRIP 3V will revert to a liquid when the cylinder falls below 45°F (7°C). If this occurs, simply warm the cylinder up above 60°F (15°C) and the propellant will revert to a gas.
 - d. In temperatures below 45°F (7°C), priming the seams is recommended to ensure seam performance.
3. Do not apply primer or SureMB 70 to damp or contaminated surfaces
4. SureMB 70 SA is not recommended for use over sealants that contain coal tar or polysulfide. If these materials are present, they must be removed, and the surfaces must be thoroughly cleaned

D. Installation

1. **Surface Preparation:** Concrete must be dry. The surface shall have a smooth finish and be free of voids, spalled areas, sharp protrusions, loose aggregate, laitance, and form release agents. In the event of rain, concrete must be allowed to dry before primer is applied. All surfaces, concrete, DensDeck, and SECUROCK must be clean.
2. **Primer:** Surface to receive SureMB 70 SA must be clean and Dry. Prime with CAV GRIP 3V, 702, 702LV or 702WB Primer. Apply primer by spray, brush, or long-nap roller at the applicable coverage rates. At 75°F (24°C), allow 702, 702LV, and 702WB Primers to dry at least one hour. Primer is satisfactorily cured when it will not transfer when touched. Only prime areas where the membrane will be installed the same day. At 75°F (24°C), allow CAV GRIP 3V to dry for a minimum of 20-30 minutes. Re-prime if area becomes dirty.
3. **Application:** Apply SureMB 70 SA from low to high point in a shingle fashion so that laps will shed water. Overlap the edges at least 2" (5 cm). End laps shall be staggered. Seam and end laps must be rolled with a 2" (5 cm) roll. Place the membrane carefully to avoid wrinkles and fishmouths. Immediately after installation, roll with a 150-LB weighted roller. When SureMB is used as a temporary roof, the following should be performed:
 - a. Apply a bead of Universal Single-Ply Sealant at the interior of the T-Joint intersections. Refer to the applicable Versico detail.
4. **Repairs:** Inspect the SureMB 70 SA for tears, punctures, fishmouths, air bubbles, and voids due to misalignment at seams. Remove the damaged membrane. Prime the exposed substrate and allow the primer to dry. Apply a new piece of 70 SA to the primed substrate, extending on the existing membrane 6" (15.2 cm) on all sides. Firmly press and roll the 70 SA repair section to ensure a good seal. Fishmouths may be repaired by slitting the fishmouth and overlap the edges. Place a piece of 70 SA over the fishmouth area, extending 6" (15.2 cm) in all directions. Firmly press and roll the repair section with a 2" roller.

5. **Insulation Installation:** Ensure that the SureMB surface is dry prior to installing insulation. Place the insulation over the surface and mechanically fasten to the roof deck or adhere to the 70 SA with Flexible DASH Adhesive in accordance with Versico specifications.
6. **Installation at Angle Changes:** To ensure proper installation, the vertical wall must be clean of debris and residual asphalt. Prime the vertical surface, ensuring the primer extends at least 2" (5 cm) up the vertical wall. After installing the SureMB 70 SA, use a seam roller on the vertical surface to ensure contact with the wall. There are two options for applying SureMB 70 SA to the vertical surface:
 - a. Option 1: Apply the 70 SA up the vertical surface to the height of the insulation, or a minimum of 2" (5 cm).
 - b. Option 2: Apply the 70 SA over the entire vertical surface, ensuring the membrane extends over the top of the wall and tie into the exterior wall air barrier when applicable.

Note: It is recommended a separation board is applied over the 70 SA prior to installing the roofing membrane to ensure long term building movement does not disrupt the 70 SA attachment to the wall.
7. **Angle Change Securement Detail G-08:** For VersiFleece Systems where the insulation is adhered to the vapor barrier or adhered roofing systems with the base securement into to vertical wall and adhered insulation, one of the following options must be incorporated to ensure that the continuous seal is provided during climatic change, especially in norther climates:
 - a. Option 1: Mechanically secure the first course of insulation (bottom layer) with insulation fasteners and plates. A row of fasteners shall be install within 6" (15.2 cm) of the angle change, spaced 12" (30.5 cm) o.c.
 - b. Option 2: In lieu of fastening, install a 3" (7.6 cm)- diameter backer rod along the angle change to accommodate for movement and prevent the effect of the vapor barrier pulling away from the angle change.

Note: Place a piece of the 70 SA release liner between the 70 SA and the backer rod to ensure they do not adhere to each other.
8. **Details:** Proper details ensure the integrity of the SureMB 70 SA as an air and vapor barrier. Details must be completed using the following materials. Standard modified roof flashing materials (available on open market), lap sealant, or VapAir Seal Flashing Foam.

Application Procedures for SureMB 90 Base Ply

A. General

1. **SureMB 90 Base Ply** – A premium smooth-surfaced, SBS-modified mop- or cold-applied base sheet. SureMB 90 Base Ply is a fiberglass mat that is saturated and coated with high-quality, asphaltic bitumen and SBS elastomers for a durable and flexible membrane which can be used as an air barrier, vapor barrier, and temporary roof (for up to 60 days). Contact Versico's Project Review & Design Department if the SureMB 90 is used as a temporary roof for more than 60 days. Available in rolls 39 3/8" (1 m) x 49' 1" (15 m). Each roll is approximately 161 FT² (15 m²).
2. **CCW-550 Primer** – A single-component, solvent-based bituminous primer designed to promote adhesion of SureMB 90 Base Ply. CCW-550 is spray-ready without having to thin, and can also be applied with a roller. CCW-550 is packaged in 5-gallon pails which cover approximately 500 FT² (46 m²). Coverage rates may vary based on substrate condition or porosity.

B. Approved Substrates

SureMB 90 Base Ply, in conjunction with CCW-550 or another approved asphalt-based primer, can be adhered directly to structural concrete, DensDeck Prime, or SECUROCK using Type III or Type IV asphalt, SBS or SEBS asphalt, or asphalt-based Cold Applied Adhesive. In addition SureMB 90 can be mechanically fastened directly to wood, gypsum, and lightweight insulating concrete decks.

C. Limitations

1. In cold weather, mopped asphalt tends to congeal rapidly and lose its adhesive characteristics, so extra care must be taken to set membrane quickly.
2. Mopped asphalt tends to congeal rapidly and lose its adhesive characteristics in cold weather, so extra care must be taken to set membrane quickly.
3. When water in any form is present on the deck, application must be suspended until the deck is dry. If moisture is present when mopping, it may cause poor adhesion and blistering of the membrane.
4. When ambient temperatures are below 45°F (7.1°C), store membrane rolls, adhesive, and primers in an area heated to a minimum temperature of 55°F (12.6°C). Install SureMB 90 immediately after removal from heated storage.
5. Do not periodically overheat asphalt above the flash point or finished blowing temperature to try to offset rapid chilling.
6. Do not apply cold adhesive in temperatures below 45°F (7.1°C).
7. In temperatures below 45°F (7.1°C), SureMB 90 must be broomed in.
8. When mopping slopes under ½" per foot (4 cm per meter), Type III or Type IV asphalt can be used. Type IV asphalt must be used for slopes greater than ¾" per foot (6.2 cm per meter).

D. Installation

1. **Surface Preparation:** Substrate must be dry and free of debris. The substrate shall have a smooth finish and be free of voids, spalled areas, sharp protrusions, loose aggregate, laitance, and form release agents. In the event of rain, the substrate must be allowed to dry before primer is applied.
2. **Primer:** Surfaces to receive SureMB 90 must be clean and dry. Prime approved substrate with CCW-550 or another approved asphalt primer. Primer is not required when adhering the SureMB 90 with Cold Applied Adhesive.
3. **Membrane Preparation:** SureMB 90 should be cut into lengths short enough to be easily handled and must be allowed to warm up and relax prior to installation. Approximate lengths may vary depending on temperature conditions. SureMB 90 must be warmed to a temperature sufficient to allow expansion and must be allowed to relax to avoid wrinkling. Place tension on the end of the roll during installation to ensure the sheet lays flat. Coiled rolls should be unrolled, placed upside-down, and allowed to relax prior to installation, then re-rolled and applied. Primer is not required when adhering the SureMB 90 with Cold Applied Adhesive.
4. **Mopping Application:** SureMB 90 may be adhered using Type III or Type IV asphalt. Asphalt shall be applied at its EVT temperature or 425°F (218°C), whichever is greater, in a uniform layer, without voids, at a rate of 25 lbs/FT² (1.2 kg/m²) ± 20%. Install full-width sheets, lapping 4" (10.2 cm) on the sides and 6" (15.2 cm) at the end laps. End laps must be staggered a minimum of 18" (45.7 cm) apart. When installing multiple plies, all side and end laps must be staggered from underlying plies. All laps must be parallel or perpendicular to the slope of the roof such that the flow of water is never against the lap. Rolls shall be installed in a fashion where asphalt is applied in the seam area to ensure watertight laps.

5. **Cold Applied Adhesive Application:** SureMB 90 Base Ply may be adhered using Versico's Cold Applied Adhesive or another approved cold adhesive. Versico's Cold Applied Adhesive is roller-applied at a coverage rate of 67 FT² (6.2 m²) per gallon. The Cold Applied Adhesive is used to adhere the seams. For membrane installation, follow the same procedures as the mopping application.
6. **Mechanical Attachment:** SureMB 90 Base Ply may be mechanically fastened when used as an air and vapor barrier. Follow the same layout instructions as the mopping application. Fasten the sheet according to Versico specifications based on uplift performance. When used as a temporary roof, another base ply or VapAir Seal 725TR must be adhered to the nailed base to ensure water-tightness.
7. **Repairs:** Following application, inspect the SureMB 90 membrane for tears, punctures, fish mouths, air bubbles (blisters), and voids due to misalignment at seams. Remove damaged membrane. Prime exposed substrate and allow to dry. Apply a new section of SureMB 90 Base Ply to the primed substrate, extending onto the membrane a minimum of 6" (15.2 cm) on all sides.
8. **Angle Change Securement Detail G-08:** For VersiFleece systems where insulation is adhered to the vapor barrier or adhered roofing systems with vertical base securement into a vertical wall and adhered insulation, to ensure that a continuous seal is provided during climatic changes, especially in northern regions:
 - a. Mechanically secure the first course of insulation (bottom layer) with insulation fasteners and plates. A row of fasteners shall be installed within 6" (15.2 cm) of the angle change, spaced 12" (30.5 cm) o.c.
9. **Details:** Proper details ensure the integrity of the SureMB 90. Details must be completed using the following materials: SureMB 90 membrane, Lap Sealant, or VapAir Seal Flashing Foam. Refer to applicable Versico details for penetrations and tie-ins.

Application Procedures for SureMB 90 TG and 120 TG Air & Vapor Barriers

A. General

1. **SureMB 90TG** – A smooth-surfaced, SBS-modified, torch-grade 90-mil base ply. SureMB 90TG Base Ply is a fiberglass mat saturated and coated with high-quality asphaltic bitumen and SBS elastomers. SureMB 90TG Base Ply can be used as an air barrier, vapor barrier, and temporary roof (for up to 60 days). Contact Versico's Project Review & Design Department if the SureMB 90TG is used as a temporary roof for more than 60 days. Available in 39 3/8" (1 m) x 49' 1" (15 m) rolls, each roll is approximately 161 FT² (15 m²).
2. **SureMB 120TG** – A smooth-surfaced, SBS-modified, torch-grade 120-mil base ply. SureMB 120TG Base Ply is a fiberglass mat saturated and coated with high-quality asphaltic bitumen and SBS elastomers. SureMB 120TG Base Ply can be used as an air barrier, vapor barrier, and temporary roof (for up to 60 days). Contact Versico's Project Review & Design Department if the SureMB 120TG is used as a temporary roof for more than 60 days. Available in rolls 39 3/8" (1 m) x 32' 9" (10 m), each roll is approximately 100 FT² (9.3 m²).
3. **CCW-550 Primer** – A single-component, solvent-based bituminous primer designed to promote adhesion of the SureMB 90TG and 120TG Base Plies. CCW-550 is spray-ready without having to thin and can also be roller-applied. CCW-550 is packaged in 5-gallon pails; each pail covers approximately 500 FT² (46.4 m²). Coverage rates may vary based on substrate condition and porosity.

B. Approved Substrates

SureMB 90TG and 120TG, in conjunction with CCW-550 or another approved asphalt-based primer, can be applied directly to structural concrete, DensDeck Prime, or SECUROCK. When using multiple layers of base ply, SureMB 90TG and 120TG can be torched directly to the first layer of base ply. In addition, when mechanically fastened, SureMB 90TG can be applied directly to wood, gypsum, and lightweight insulating concrete decks.

C. Limitations

1. Store membrane rolls, adhesives, and primers in an area heated to a minimum temperature of 55°F (12.6°C) when ambient temperature is below 45°F (7.1°C). Install SureMB 90TG or 120TG immediately after removal from heated storage.
2. In temperatures below 45°F (7.1°C), brooming in the SureMB 90TG or 120TG is required.

D. Installation

1. **Surface Preparation:** Substrate must be free of debris and must be dry. The substrate shall have a smooth finish and be free of voids, spalled areas, sharp protrusions, loose aggregate, laitance, and form release agents. In the event of rain, the substrate must be allowed to dry before primer is applied.
2. **Primer:** Surfaces to receive SureMB 90TG or 120TG must be clean and dry. Prime approved substrate with CCW-550 or another approved asphalt primer. Allow the primer to dry completely before starting membrane application.
3. **Membrane Preparation:** SureMB 90TG and 120TG should be cut into lengths short enough to be easily handled and should be allowed to warm up and relax prior to installation. Approximate lengths may vary depending on temperature conditions. The base ply must be warmed to a temperature sufficient to allow expansion and relaxation time to avoid wrinkling. Place tension on the end of the roll during installation to ensure the sheet lays flat. Coiled rolls should be unrolled, placed upside down and allowed to relax prior to installation; then, re-roll and apply.
4. **Torching Application:** SureMB 90TG and 120TG SBS membranes are more flexible than APP. Overheating of the underside may cause excessive softness to the top side. Extreme care should be taken to avoid overheating the sheet. The coiled membrane must be unrolled and allowed to relax, then re-rolled to apply. Unroll approximately 10' (3 m), align the roll, and then re-roll for application. To install, apply the propane torch flame uniformly across the exposed back surface of the membrane and lap areas until the compound reaches the proper application temperature and exhibits a slight sheen. Be sure there is complete burn-off of the release film on the underside of the roll and membrane selvage edge. Avoid overheating, which may result in damage to or improper adhesion of the membrane.
 - a. The flame should be moved from side to side in the shape of an "L", applying about 80% of the heat to the membrane and 20% to the substrate or underlying plies, including the lap area of the previously installed course. The membrane is unrolled as the heat is applied to ensure proper adhesion.
 - b. A minimum ¼" (6.5 mm) bitumen flow-out must be obtained at all seam areas. Dry laps are not acceptable. To ensure a proper ¼" (6.5 mm) flow of bitumen at the seam areas, a weighted roller may be used. Roller application should follow behind the torch no more than 4 ft. (1.2 m) or less than 3 ft. (0.91 m) to ensure the membrane is at proper temperature to produce proper flow. Hand rollers or "walking-in the seam" methods are also acceptable. Check all seams for full and uniform adhesion. Un-adhered seams must be lifted with a heated trowel and resealed by lightly torching the seam area.

- c. All end laps must be staggered a minimum of 18" (45.7 cm) so that no adjacent end laps coincide. If end laps fall in line or are not staggered, a full width of Sure MB 90TG or 120TG membrane must be installed over the end lap.
 - d. All laps must be parallel or perpendicular to the slope of the roof to ensure water is never against the lap.
 - e. Membranes may not be applied during adverse weather or without precautionary measures in temperatures below 45°F (7.2°C).
5. **Mechanical Attachment:** SureMB 90TG and 120TG may be mechanically fastened when used as an air and vapor barrier or temporary roof. Follow the fastening pattern in Versico's specifications. When used as a temporary roof over gyp, tectum, wood, or lightweight concrete, it is acceptable to fasten the sheet at the edge and lap the next sheet over the fastener. Use an approved heat welder to seam the sheets together. If the roof insulation is to be adhered to the SureMB 90TG or 120TG, install additional fasteners in the field of the sheet according to Versico specifications.
 6. **Repairs:** Following application, inspect the SureMB 90TG or 120TG membrane for tears, punctures, fishmouths, air bubbles (blisters), and voids due to misalignment at seams. Remove damaged membrane. Prime exposed substrate and allow to dry. Apply a new section of membrane to the primed substrate, extending onto the membrane in place a minimum of 6" (15.2 cm) on all sides.
 7. **Angle Change Securement Detail G-08:** For VersiFleece systems where insulation is adhered to the vapor barrier or adhered roofing systems with vertical base securement into a vertical wall and adhered insulation, angle change securement must be incorporated to ensure a continuous seal is provided during climatic changes, especially in northern regions:
 - a. Mechanically fasten the first course of insulation (bottom layer) with insulation fasteners and plates. A row of fasteners shall be installed within 6" (15.2 cm) of the angle change spaced 12" (30.5 cm) o.c.
 8. **Details:** Proper details ensure the integrity of the Air and Vapor Barrier/Temporary Roof. Details must be completed using the following materials: Modified flashing material or VapAir Seal Flashing Foam. Refer to applicable Versico details for penetrations and tie-ins.

SECTION 5: AIR & VAPOR BARRIER ACCESSORIES



CAV-GRIP 3V Low-VOC Adhesive/Primer

CAV-GRIP 3V is a low-VOC, spray applied aerosol contact adhesive and primer used for a variety of applications: adhering standard TPO and EPDM membranes to horizontal and vertical surfaces, adhering VersiFleece membranes to vertical surfaces, as a primer for VapAir Seal 725TR, and as an unexposed asphalt primer for Flexible DASH. CAV-GRIP 3V's self-contained spray system provides quick and even coverage and requires minimal cleanup or maintenance. Cylinder, hoses, and gun are each sold separately.

Features and Benefits

- Can be used in temperatures as low as 25°F (-4°C)
- Easy cleanup
- Tenacious bond
- Low-VOC and low odor

Productivity Boosting Features and Benefits

- Quick application with spray gun
- Fast set-up time (approximately 5 minutes)
- No stirring
- Up to 60% labor savings compared to traditional bonding adhesive



CCW-702 and CCW-702LV

CCW-702 and 702LV are solvent-based, high-tack adhesives specifically designed to promote maximum adhesion of VapAir Seal 725TR Air and Vapor Barrier/Temporary Roof to approved substrates. These products are also used as a surface prep to promote adhesion of Flexible DASH Adhesive. CCW-702 and 702LV are available in 5-gallon pails. CCW-702WB is a water-based adhesive.

Features and Benefits

- Enhances the bond between VapAir Seal 725TR Air and Vapor Barrier/Temporary Roof and approved substrates
- Can be walked on once cured/ flashed off
- Acts as a surface prep to facilitate adhesion of Flexible DASH Adhesive



VapAir Seal Flashing Foam

VapAir Seal Flashing Foam is a low-pressure foam system that utilizes a non-flammable blowing agent and is specifically designed to be sprayed onto flat or irregular surfaces and to fill large cavities. This product has been specifically formulated for flame retardance and conforms to the requirements of ASTM E84 as a "Class 2(B)" system (flame spread of 75 or less, smoke development of 450 or less). The foam helps to lower heating and cooling costs by reducing air leakage and can be sprayed onto any clean, dry surface in any direction to insulate, fill, and seal various sizes of voids. To complete the flashing around penetrations, VapAir Seal Flashing Foam is applied below the insulation level.

Features and Benefits

- Fully expands and dries tack-free within 30-60 seconds; can be cut in 2-5 minutes.
- Adheres to most building materials with the exception of surfaces such as silicone, oils, greases, mold release agents, and similar materials.
- Effective for all roof penetrations.
- Creates a seamless, continuous seal to insulate and protect against vapor and air infiltration.
- Cured foam is resistant to heat and cold, -200°F to +115.5°F (-128.9°C to +115.5°C), and to aging, but not to UV rays unless painted, covered or coated.

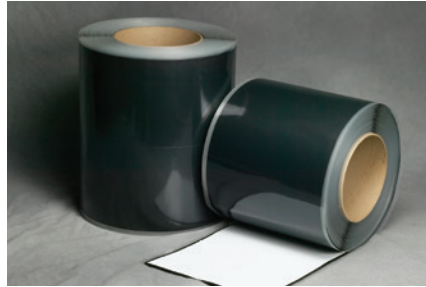

Quick-Applied Uncured EPDM Flashing

Quick-Applied Uncured EPDM Flashing is a nominal 60-mil-thick (1.5 mm) uncured EPDM membrane laminated to a nominal 30-mil-thick (0.75 mm) fully cured QA adhesive. This product is available in 6" x 100' (15.2 cm x 30.5 m), 9" x 50' (23 cm x 15.2 m), and 12" x 50' (30.5 cm x 15.2 m) rolls and is easily malleable and highly adaptable to irregular shapes and surfaces. QA Uncured EPDM Flashing is self-curing and can be used to flash pipes and scuppers, as well as other rooftop structures and penetrations. The clear poly release liner on the 12" (30.5 cm)-wide product is pre-slit down the center, allowing the applicator to partially remove the liner for ease of installation.

Features and Benefits

- Available in 6" x 100', 9" x 50', and 12" x 50' rolls
- Adaptable to irregular shapes and surfaces
- Self-curing membrane
- Labor and cost savings in field applications



V-150 EPDM Primer

V-150 EPDM Primer is a solvent-based product designed for one-step cleaning and priming of EPDM surfaces prior to the application of Quick-Applied Seam Tape, Factory Applied QAT, and all other quick-applied products.

Features and Benefits

- One-step cleaner and primer used in conjunction with all quick-applied accessories on EPDM membranes
- Coverage rates up to 450 FT²/gallon (42 m²) with clean (no dust) membrane

Coverage Rate

Approximately 250 FT²/gallon (23 m²) can be expected when properly applied to standard membrane. Coverage rates as high as 450 FT²/gallon (42 m²) can be expected with clean (no dust) membrane.



Low-VOC Primer

Low-VOC Primer is a solvent-based product designed for one-step priming of EPDM or TPO surfaces prior to the application of factory-Applied QAT, Cover Strip, Quick-Applied Seam Tape, and all other quick-applied products. This product is designed to comply with VOC regulations.

Features and Benefits

- One-step primer used in conjunction with all quick-applied accessories on EPDM or TPO membranes
- Coverage rates up to 700 FT²/gallon (65 m²) with TPO or clean (no dust) EPDM membrane
- VOC less than 250 g/l
- Excellent long-term peel and shear strength

Coverage Rate

Approximately 250 FT²/gallon (23 m²) can be expected when properly applied to dusted EPDM membrane. Coverage rates as high as 700 FT²/gallon (65 m²) can be expected with TPO or clean (no dust) EPDM.



CCW-550 Primer

CCW-550 Primer is a single-component, solvent-based bituminous primer. CCW-550 Primer is spray-ready without having to thin, and can also be applied with a roller. Use on all concrete, gypsum, masonry, brick, plywood, and metal surfaces to which the SureMB 90 or SureMB 90TG or 120TG is to be applied.

Features and Benefits

- Can be spray- or roller-applied
- Available in 5-gallon pails and 55-gallon drums
- Complies to ASTM D41

Coverage Rate

Coverage rates will vary; the following is a guide. The concrete should show a deep stain as opposed to being fully colored black. For smooth, hair broom finish, cover concrete 500 FT² (46.4 m²) per gallon. All fluid-applied product application rates are based on theoretical coverage relative to the percentage of solids in the material. These are minimum application rates to achieve the required dry film thickness for the system and do not account for substrate condition or porosity. A thicker application of the product may be necessary to achieve the required dry film thickness for the system, relative to the substrate.

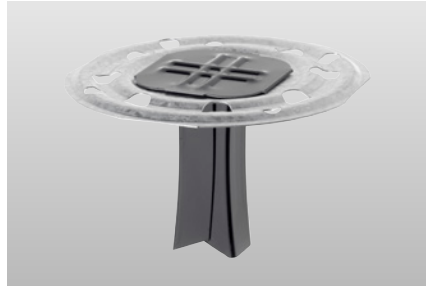

Dual Prong Base Sheet Fastener

Dual Prong Base Sheet Fastener is designed to secure base sheets over gypsum, fibrous cement, and lightweight concrete decks. The Dual Prong Fastener consists of a galvanized (G-90) tube designed to easily penetrate decking and existing membranes, a 2.7" (6.9 cm)-diameter Galvalume plate which is securely clamped to the tube and ribbed to resist cupping, and a locking staple formed from coated, high-tensile steel wire for corrosion resistance. Dual Prong Fasteners are installed using the Versico Dual Prong Applicator, a stand-up applicator that holds and drives the tube into the deck, then sets the wires.

SECTION 6: DETAILS

AIR / VAPOR CONTROL LAYERS

A APPLICABLE SUBSTRATES & SEAM DETAIL

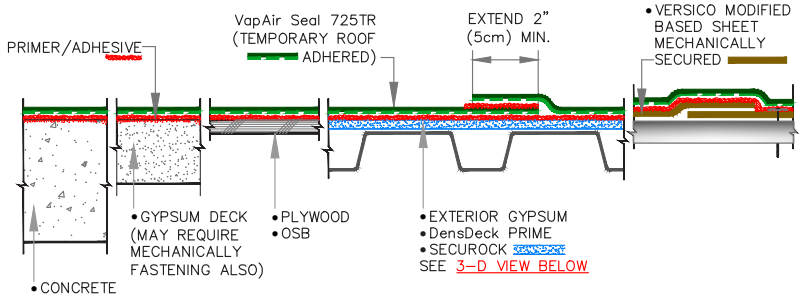

B 3-D VIEW OF TYPICAL ROOF ASSEMBLY

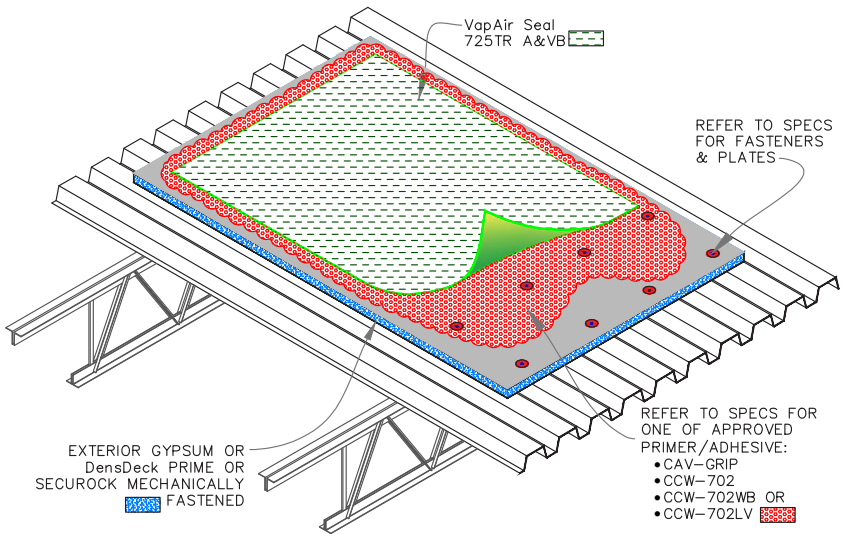

SEE SHEET TR-0 FOR ADDITIONAL INFORMATION.

VapAir Seal 725TR



INSTALLATION
(PAGE 1 OF 2)

- VapAir Seal 725TR
- ROOF MEMBRANE
- BONDING ADHESIVE
- 1 → SEE NOTE(S)

DETAIL NO.

TR-0

ADHERED A&VB

AIR / VAPOR CONTROL LAYERS

C T-JUNCTION OF SEAMS WITH SEALANT

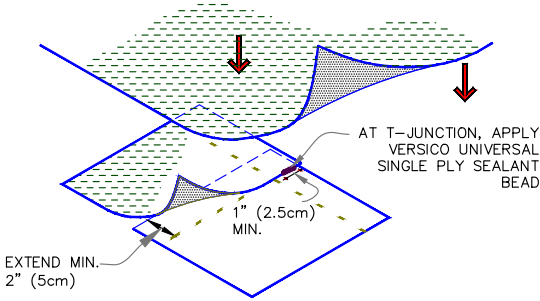

D ROOF TO WALL TRANSITION

NOTES:

1. EXTEND VapAir Seal 725TR TO TOP EDGE OF ROOF INSULATION OR MIN. 2" (5cm).
2. HAND ROLL VERTICAL SURFACES WITH 2" (5cm) WIDE PRESSURE ROLLER.
3. WHEN VapAir Seal 725TR HAS TO BE EXTENDED UP THE WALL (TO SEAL WITH EXTERIOR WALL BARRIERS), IT SHOULD BE COVERED WITH INSULATION BOARD (MIN. R-VALUE 6) TO AVOID CONDENSATION AND ALSO TO AVOID UNEQUAL EXPANSION/CONTRACTION OF MEMBRANES. BOARD WILL PROVIDE A SUBSTRATE FOR ROOF MEMBRANE ALSO.
4. DIRECT ADHESION OF ROOF MEMBRANE TO VapAir Seal 725TR IS NOT RECOMMENDED.

AT SEAMS INSTALL MIN. 4"X4" (10X10cm) VapAir Seal 725TR AT 90° TURNS, CENTRALLY ALIGN AND PRESSURE ROLL THE SEAMS.

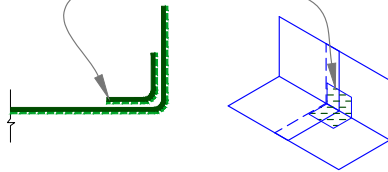

SEE SHEET TR-0 FOR ADDITIONAL INFORMATION.

VapAir Seal 725TR



INSTALLATION
(PAGE 2 OF 2)

- VapAir Seal 725TR
- ROOF MEMBRANE
- BONDING ADHESIVE
- 1 → SEE NOTE(S)

DETAIL NO.

TR-0

ADHERED: A&V

AIR / VAPOR CONTROL LAYERS

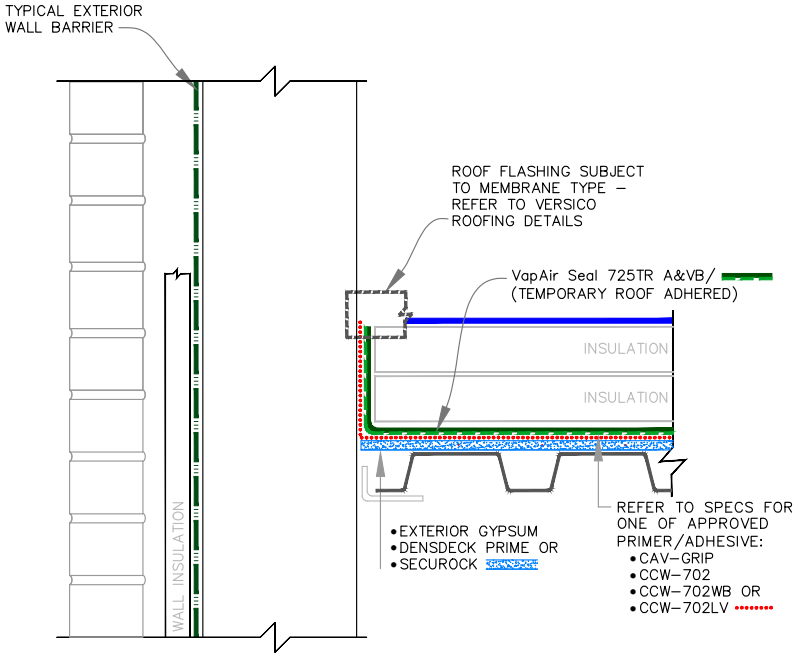

SEE SHEET TR-0 FOR ADDITIONAL INFORMATION.

VapAir Seal 725TR



PARAPET (NO TIE-IN TO WALL VAPOR BARRIER)

- VapAir Seal 725TR
- ROOF MEMBRANE
- BONDING ADHESIVE
- 1 → SEE NOTE(S)

DETAIL NO.
TR-1.1
ADHERED A&VB

AIR / VAPOR CONTROL LAYERS

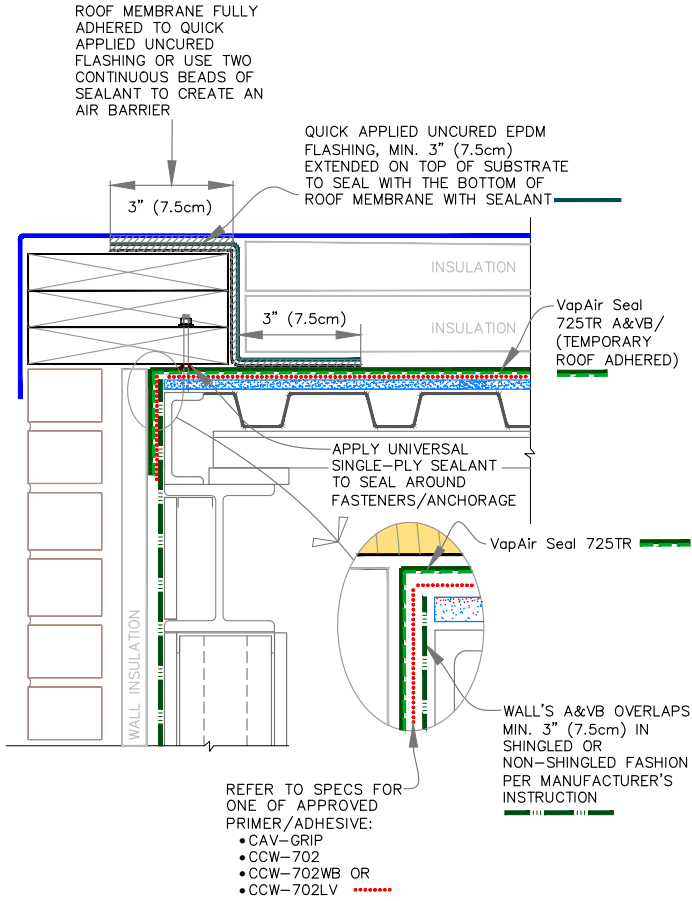

SEE SHEET TR-0 FOR ADDITIONAL INFORMATION.

VapAir Seal 725TR



ROOF EDGE
ROOF A&VB TIE-IN TO
WALL A&VB

- VapAir Seal 725TR
- ROOF MEMBRANE
- BONDING ADHESIVE
- 1 → SEE NOTE(S)

DETAIL NO.
TR-1.2
ADHERED A&VB

AIR / VAPOR CONTROL LAYERS

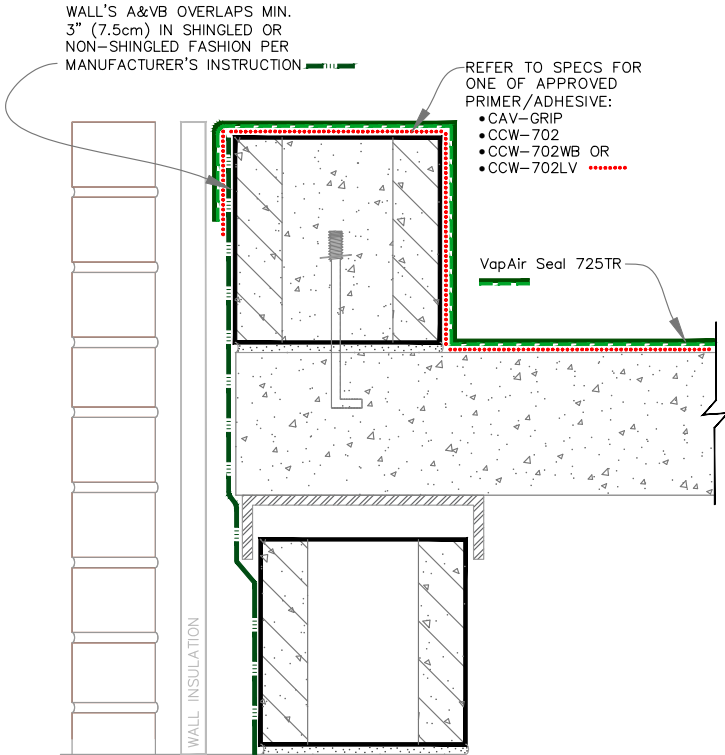



SEE SHEET TR-0 FOR ADDITIONAL INFORMATION.

VapAir Seal 725TR



PARAPET ON ROOF DECK
ROOF A&VB TIE-IN TO
WALL A&VB

-  → VapAir Seal 725TR
-  → ROOF MEMBRANE
-  → BONDING ADHESIVE
- 1 → SEE NOTE(S)

DETAIL NO.
TR-1.3
ADHERED A&VB

AIR / VAPOR CONTROL LAYERS

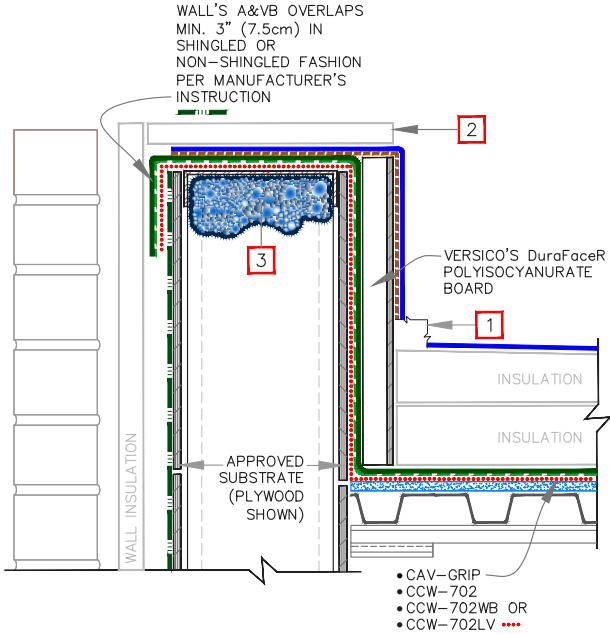

NOTES:

1. REFER TO VERSICO STANDARD DETAILS FOR ROOF BASE FLASHING
2. VERSICO SECURSHIELD HD COMPOSITE BOARD, 100 PSI (6.9 KILOPASCAL) COMPRESSIVE STRENGTH [SUGGESTED IN ASHRAE ZONES 6-8 (ZONES B TO D IN CANADA)] OR WHERE CODE REQUIRES FOR c.i. (CONTINUOUS INSULATION).
3. IN HIGH HUMIDITY SPACES, USE VapAir Seal Flashing Foam PER SPECIFICATIONS, [SUGGESTED IN ASHRAE ZONES 6-8 (ZONES B-D IN CANADA)]
4. WHEN WALL BARRIER IS ABOVE ROOF MEMBRANE, THEN USE MASTIC RECOMMENDED BY WALL BARRIER MANUFACTURER.

SEE SHEET TR-0 FOR
ADDITIONAL INFORMATION.

VapAir Seal 725TR



PARAPET (CONTINUOUS
WALL) A&VB TIE-IN TO
WALL A&VB

- VapAir Seal 725TR
- ROOF MEMBRANE
- BONDING ADHESIVE
- SEE NOTE(S)

DETAIL NO.

TR-1.4

ADHERED A&VB

AIR / VAPOR CONTROL LAYERS

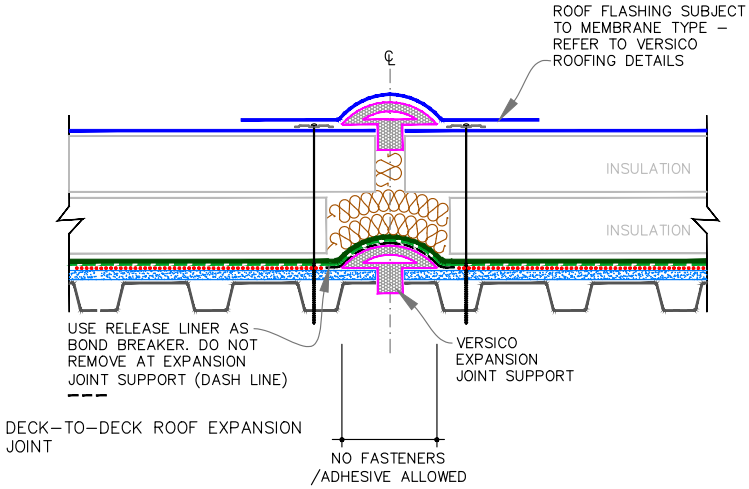

NOTE:

1. REFER TO TYPICAL EXPANSION JOINT DETAIL FOR SELECTED ROOF ASSEMBLY TYPE

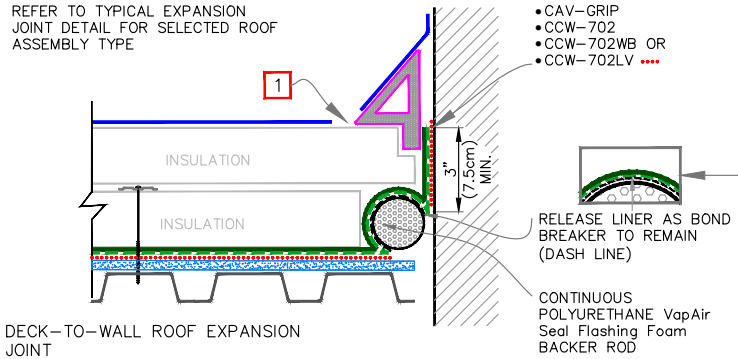

SEE SHEET TR-0 FOR ADDITIONAL INFORMATION.

VapAir Seal 725TR



EXPANSION JOINTS

- VapAir Seal 725TR
- ROOF MEMBRANE
- BONDING ADHESIVE
- 1 → SEE NOTE(S)

DETAIL NO.

TR-3.1

ADHERED A&V/R

AIR / VAPOR CONTROL LAYERS

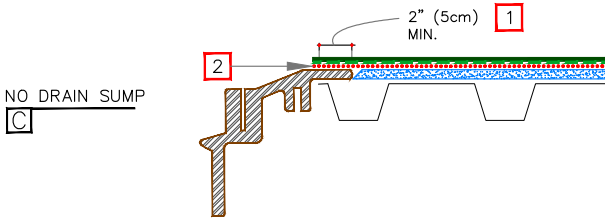
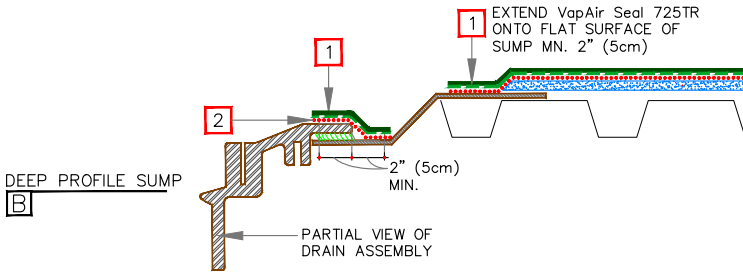
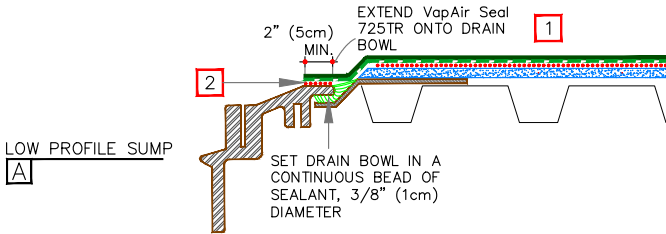

NOTES:

1. HAND ROLL WITH 2" (5cm) WIDE PRESSURE-ROLLER & ENSURE ANY FISH-MOUTHS ARE SEALED WITH SEALANT.
2. USE PRIMER IF SURFACES ARE RUSTY/UNCLEAN/POOR ADHESION IS EXPERIENCED. VapAir Seal MD ADHERED TO METAL DECK AND STEEL PLATE.
3. ENSURE HOLES ARE OPEN BEFORE THE END OF THE DAY OR PRIOR TO RAIN.

REFER TO SPECS FOR ONE OF APPROVED PRIMER/ADHESIVE:

- CAV-GRIP
- CCW-702
- CCW-702WB OR
- CCW-702LV *****

SEE SHEET TR-0 FOR ADDITIONAL INFORMATION.

VapAir Seal 725TR



ROOF DRAIN WITH VARYING SUMP CONDITIONS

- VapAir Seal 725TR
- ROOF MEMBRANE
- BONDING ADHESIVE
- SEE NOTE(S)

DETAIL NO.

TR-6.1

ADHERED A&V

AIR / VAPOR CONTROL LAYERS

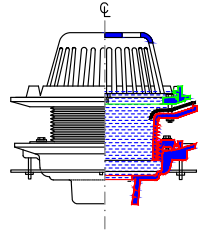
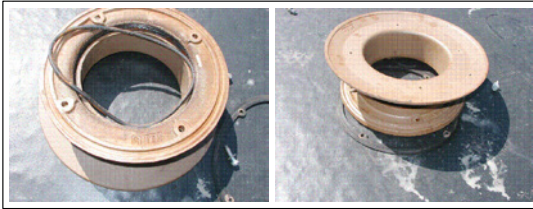

ADJUSTABLE DRAIN – TYPE A

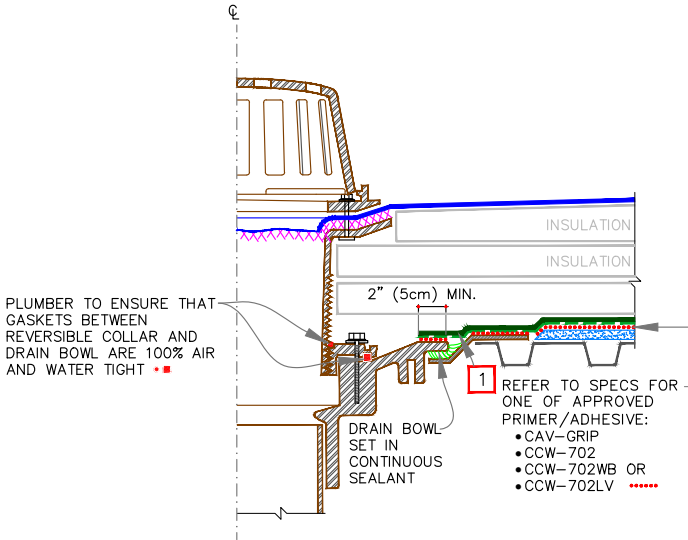

NOTE

1. EXTEND VapAir Seal 725TR ONTO DRAIN'S FLAT AREA AND HAND ROLL WITH 2" (5cm) WIDE PRESSURE-ROLLER & ENSURE ANY FISH-MOUTHS ARE SEALED WITH SEALANT

SEE SHEET TR-0 FOR ADDITIONAL INFORMATION.

VapAir Seal 725TR



ROOF DRAIN WITH ADJUSTABLE HEIGHT – TYPE A

- VapAir Seal 725TR
- ROOF MEMBRANE
- BONDING ADHESIVE
- 1 → SEE NOTE(S)

DETAIL NO.

TR-6.2

ADHERED A&VB

AIR / VAPOR CONTROL LAYERS

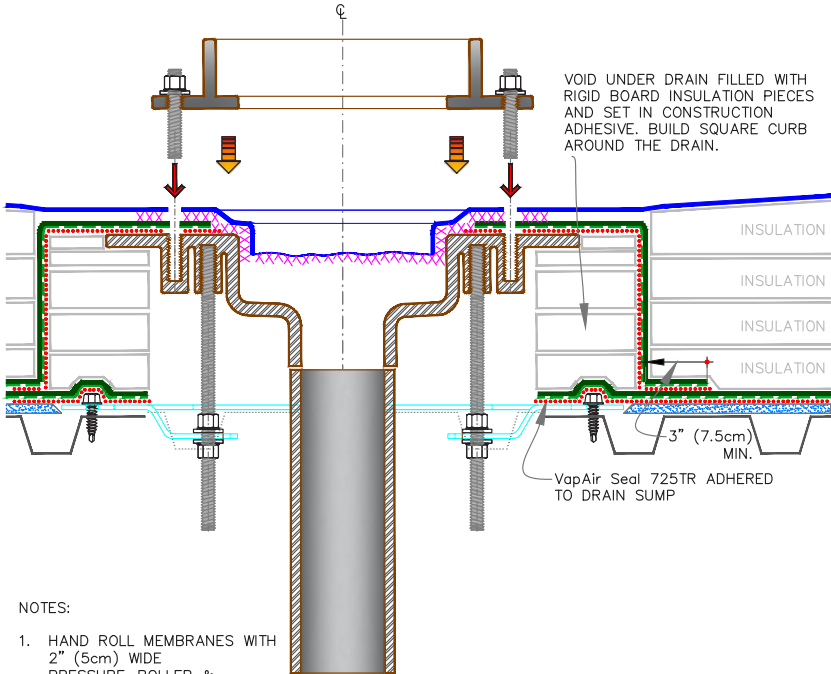

NOTES:

1. HAND ROLL MEMBRANES WITH 2" (5cm) WIDE PRESSURE-ROLLER & ENSURE ANY FISH-MOUTHS ARE SEALED WITH SEALANT
2. USE PRIMER IF SURFACES ARE RUSTY/UNCLEAN/POOR ADHESION IS EXPERIENCED.
3. DESIGNER MAY ADD DRAIN INSULATION FROM INSIDE

SEE SHEET TR-0 FOR ADDITIONAL INFORMATION.

VapAir Seal 725TR



ROOF DRAIN WITH ADJUSTABLE HEIGHT - TYPE B

- VapAir Seal 725TR
- ROOF MEMBRANE
- BONDING ADHESIVE
- 1 → SEE NOTE(S)

DETAIL NO.

TR-6.3

ADHERED: A&VB

AIR / VAPOR CONTROL LAYERS

NOTE: REFER TO DETAIL TR-8.3, WHERE MULTIPLE PENETRATIONS EXIST IN ONE AREA

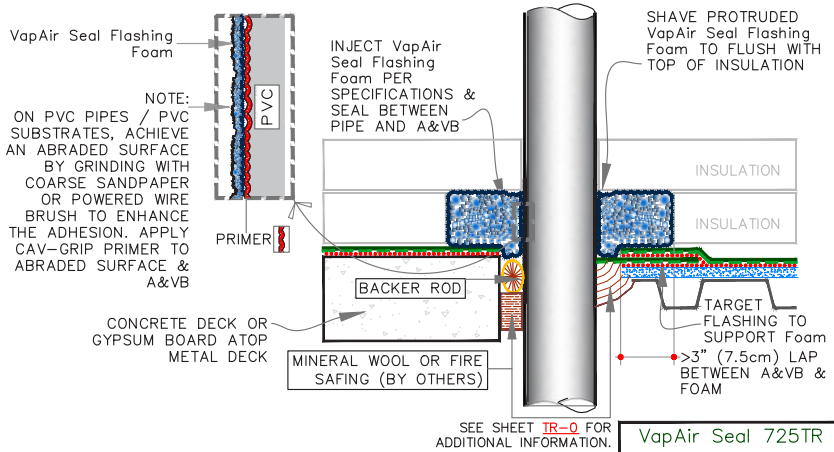
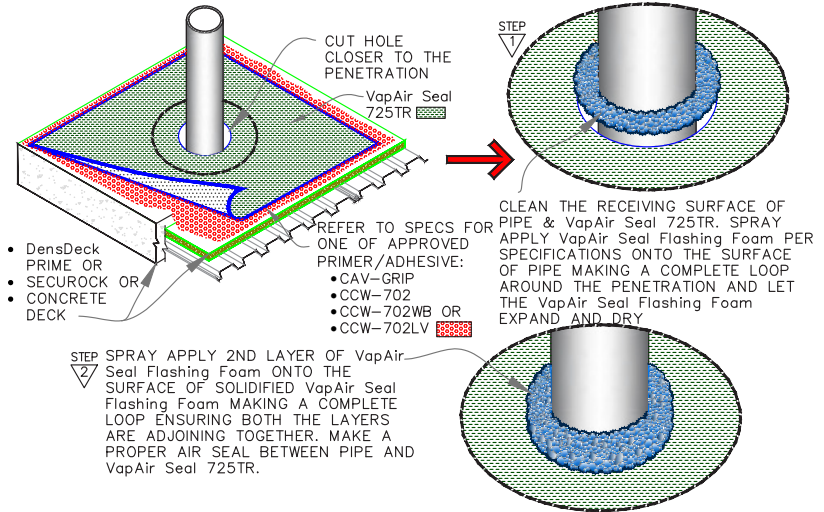

PIPE FLASHING SEALED WITH VapAir Seal Flashing Foam PER SPECIFICATIONS

- VapAir Seal 725TR
- ROOF MEMBRANE
- BONDING ADHESIVE
- 1 → SEE NOTE(S)

DETAIL NO. TR-8.1

ADHERED A&VB

AIR / VAPOR CONTROL LAYERS

NOTE: REFER TO DETAIL **TR-8.3**, WHERE MULTIPLE PENETRATIONS EXIST IN ONE AREA

DO NOT CUT EXCESSIVELY LARGE HOLE THAN PENETRATION SIZE

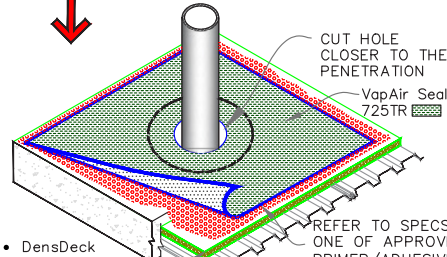
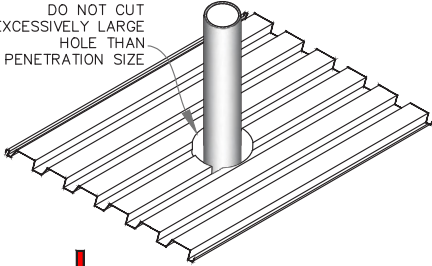

- DensDeck PRIME OR
- SECUROCK OR
- CONCRETE DECK

REFER TO SPECS FOR ONE OF APPROVED PRIMER/ADHESIVE:

- CAV-GRIP
- CCW-702
- CCW-702WB OR
- CCW-702LV

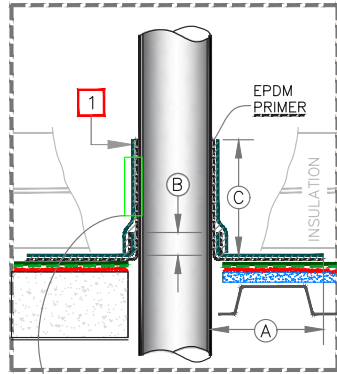

DIMENSIONS		cm
(A)	3"	7.5 MIN.
(B)	1/2"	1.5 MIN.
(C)	MIN. 3" (7.5cm) OR MAX. BELOW THE HEIGHT OF INSULATION	

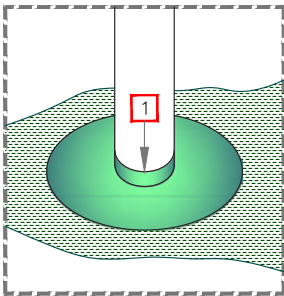

1 QUICK APPLIED UNCURED FLASHING IN CONJUNCTION WITH EPDM PRIMER.

NOTE: ON PVC PIPES / PVC SUBSTRATES, ACHIEVE AN ABRADED SURFACE BY GRINDING WITH COARSE SANDPAPER OR POWERED WIRE BRUSH TO ENHANCE THE ADHESION. APPLY CAV-GRIP PRIMER TO ABRADED SURFACE & A&VB

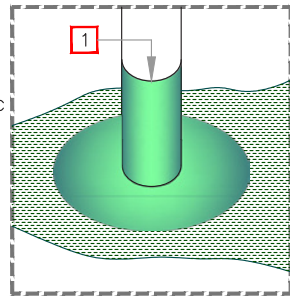

SEE SHEET **TR-0** FOR ADDITIONAL INFORMATION.

VapAir Seal 725TR



PIPE FLASHING WITH QUICK APPLIED UNCURED FLASHING

- VapAir Seal 725TR
- ROOF MEMBRANE
- BONDING ADHESIVE
- 1** → SEE NOTE(S)

DETAIL NO.
TR-8.2
ADHERED A&VB

AIR / VAPOR CONTROL LAYERS

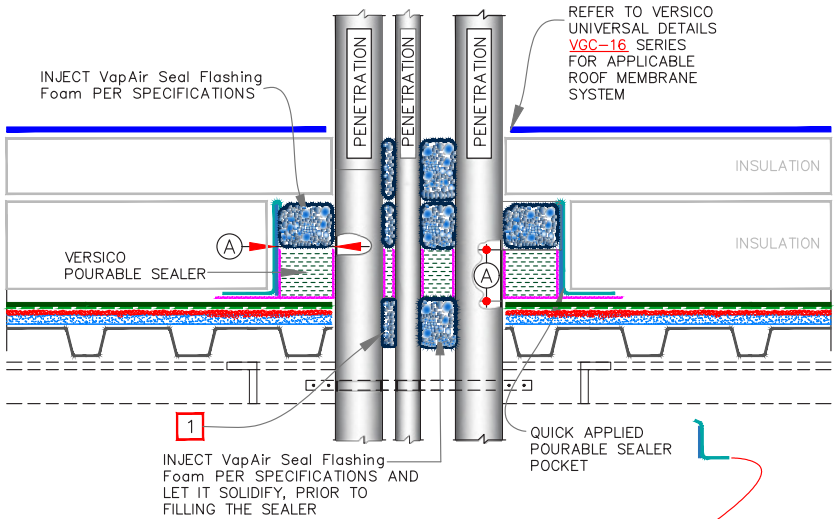

NOTES:

1. THE MAXIMUM ALLOWABLE SURFACE TEMPERATURE OF THE PENETRATION SHALL NOT EXCEED 180° F (82° C).
2. PENETRATIONS, AIR & VAPOR BARRIER, FLASHING AND METAL (INSIDE POCKET) MUST BE PRIMED WITH EPDM PRIMER PRIOR TO APPLYING POURABLE SEALER. DO NOT PRIME THE BLUE PLASTIC SUPPORT STRIP.
3. POURABLE SEALER MUST CONTACT PRIMED QUICK APPLIED UNCURED FLASHING AND AIR & VAPOR BARRIER.
4. SECUREMENT IS REQUIRED FOR POURABLE SEALER POCKETS WHICH ARE GREATER THAN 18" (46cm) IN DIAMETER. REFER TO SPECIFICATIONS.
5. PIPE CLUSTERS MUST HAVE MINIMUM 1" (2.5cm) CLEARANCE BETWEEN PENETRATIONS.
6. 22 GAUGE STEEL STRIPS TO FILL GAPS & SUPPORT THE SEALER POCKET. FASTEN INTO DECK

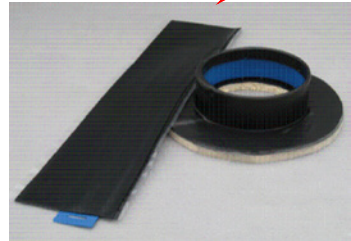

DIMENSIONS		cm	
A	1/2"	1.5	TO
	1"	2.5	

SEE SHEET TR-0 FOR ADDITIONAL INFORMATION.

VapAir Seal 725TR



PIPE FLASHING MULTIPLE PIPES IN GROUP

- VapAir Seal 725TR
- ROOF MEMBRANE
- BONDING ADHESIVE
- 1 → SEE NOTE(S)

DETAIL NO.

TR-8.3

ADHERED A&VP

AIR / VAPOR CONTROL LAYERS



NOTE:

1. USE OF HIGH TEMPERATURE STACK INSULATION IS RECOMMENDED TO PROTECT VapAir Seal 725TR FROM EXTREME TEMPERATURE.

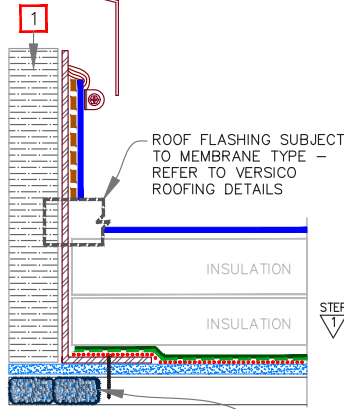

ROOF FLASHING SUBJECT TO MEMBRANE TYPE – REFER TO VERSICO ROOFING DETAILS

INSULATION

INSULATION

STEP

▽

SUBSTRATE BOARD IS INSTALLED FIRST TO CONTAIN VapAir Seal Flashing Foam INSULATION

HEAVY GAUGE ROUND/SQUARE CURB SECURED TO METAL DECK

STEP

▽

FILL THE BOTTOM FLUTES WITH VapAir Seal Flashing Foam PER SPECIFICATIONS TO AVOID THE MIGRATION OF HUMID AIR, STEAM, OR HOT GASES LEAKING FROM ADJACENT FLUE.

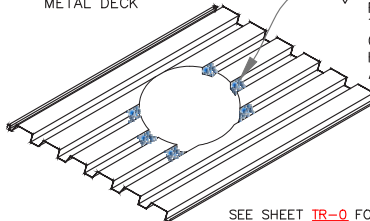

SEE SHEET TR-0 FOR ADDITIONAL INFORMATION.

VapAir Seal 725TR



HOT VENT STACK WITH METAL CURB AT DECK

- VapAir Seal 725TR
- ROOF MEMBRANE
- BONDING ADHESIVE
- 1 → SEE NOTE(S)

DETAIL NO.

TR-8.6A

ADHERED A&V®

AIR / VAPOR CONTROL LAYERS

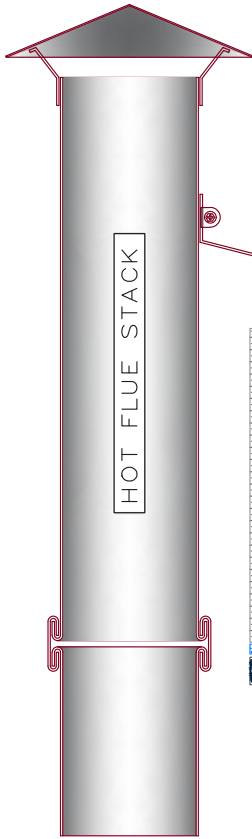



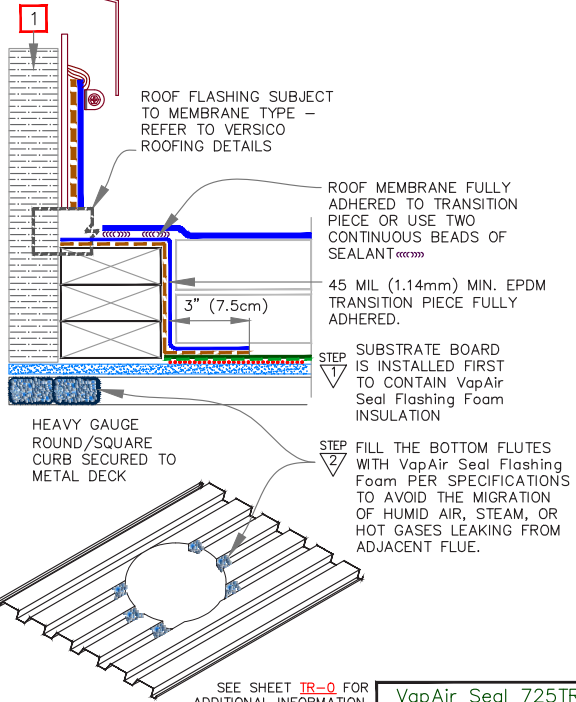

NOTE:

1. USE OF HIGH TEMPERATURE STACK INSULATION IS RECOMMENDED TO PROTECT VapAir Seal 725TR FROM EXTREME TEMPERATURE.



HOT VENT STACK WITH WOOD CURB

-  → VapAir Seal 725TR
-  → ROOF MEMBRANE
-  → BONDING ADHESIVE
-  → SEE NOTE(S)

VapAir Seal 725TR

DETAIL NO.
TR-8.6B

ADHERED A&V

AIR / VAPOR CONTROL LAYERS

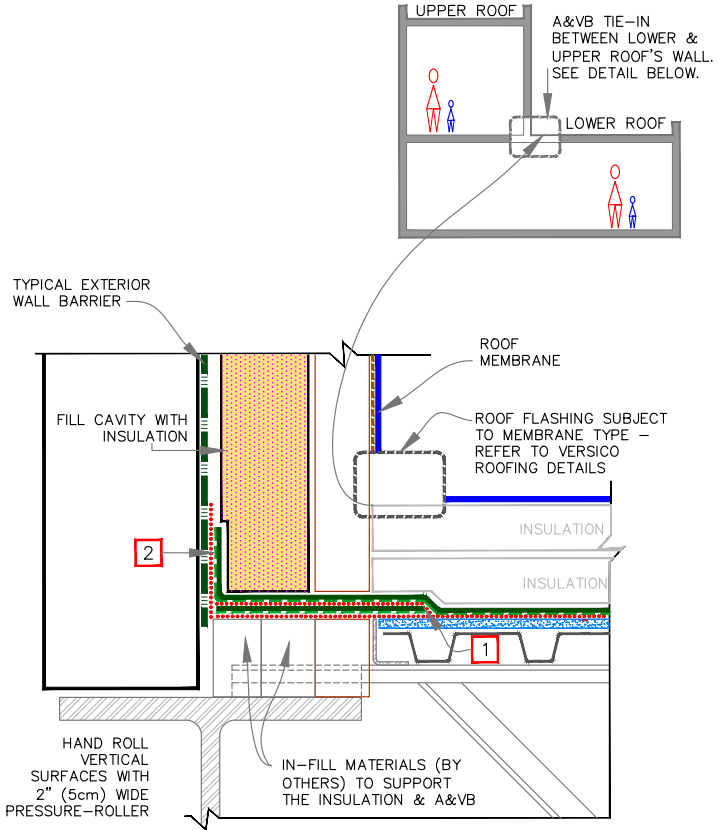

NOTES:

1. SET THRU-WALL STAINLESS STEEL STRIP FLASHING AND EXTEND IT OUT MIN. 3" (7.5cm) (BY OTHERS).
2. EXTEND VapAir Seal 725TR MIN. 6" (15cm) VERTICAL AND FULLY ADHERE TO WALL'S A&VB. WHEN WALL'S A&VB IS NOT INSTALLED YET, THEN ADHERE TO WALL. WALL BARRIER SHALL BE FULLY ADHERED TO VapAir Seal 725TR.

SEE SHEET TR-0 FOR ADDITIONAL INFORMATION.

VapAir Seal 725TR



TIE-IN TO UPPER STORY WALL

- VapAir Seal 725TR
- ROOF MEMBRANE
- BONDING ADHESIVE
- SEE NOTE(S)

DETAIL NO.
TR-12.1
ADHERED A&VB

AIR / VAPOR CONTROL LAYERS

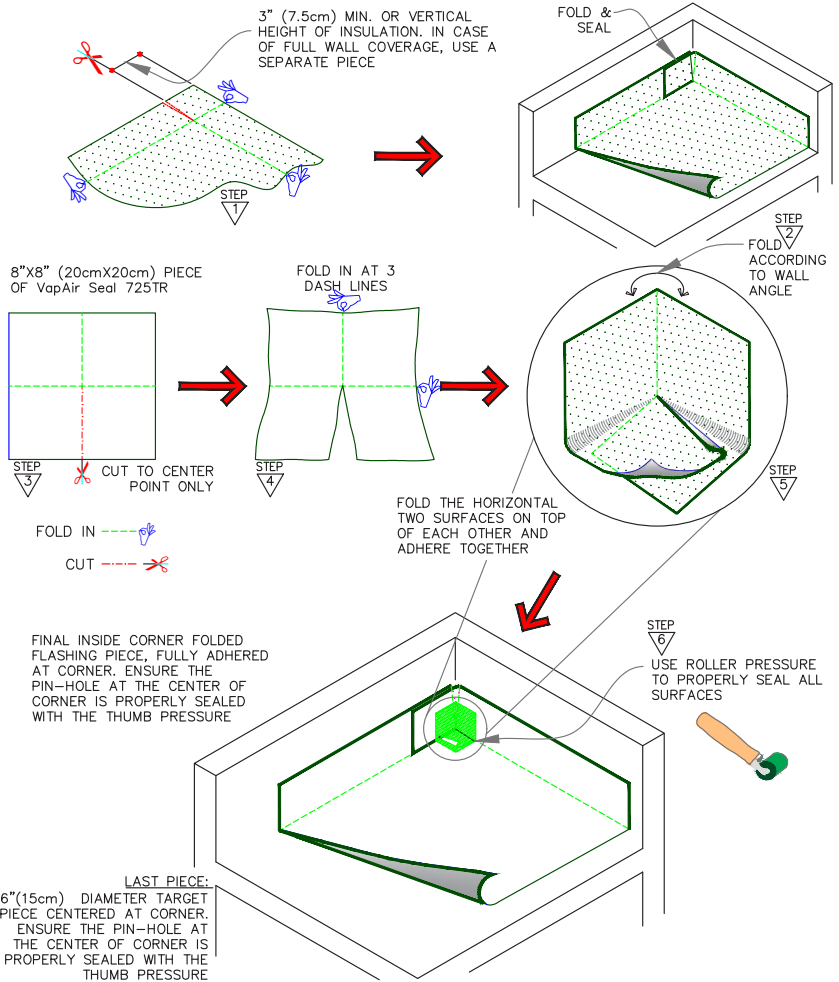





SEE SHEET TR-0 FOR ADDITIONAL INFORMATION.

VapAir Seal 725TR



INSIDE CORNER WITH VapAir Seal 725TR FLASHING

-  → VapAir Seal 725TR
-  → ROOF MEMBRANE
-  → BONDING ADHESIVE
-  → SEE NOTE(S)

DETAIL NO.
TR-15.1A
ADHERED A&VB

AIR / VAPOR CONTROL LAYERS

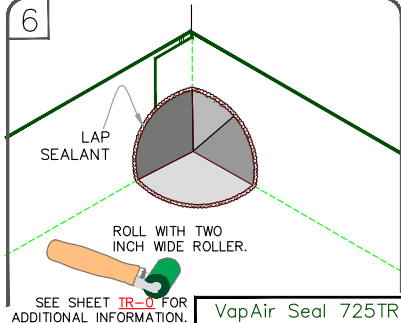
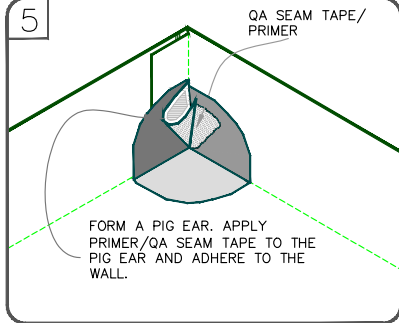
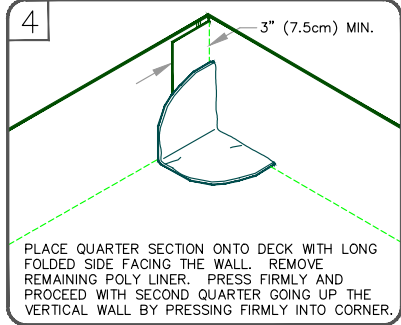
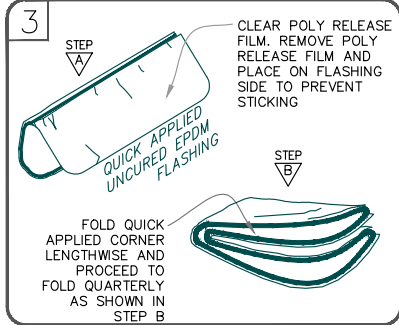
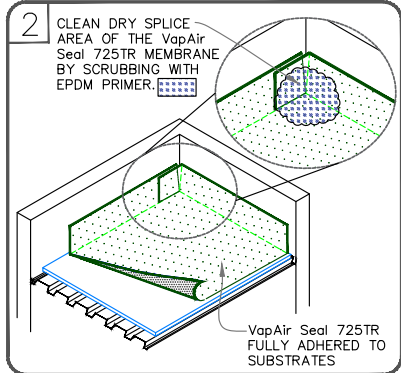
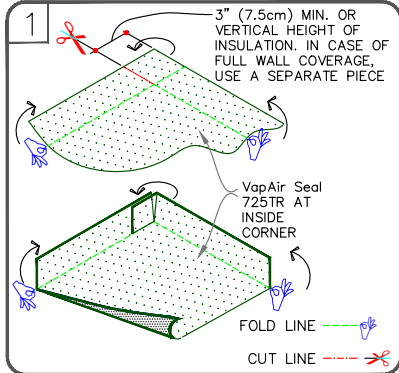

VapAir Seal 725TR



INSIDE CORNER WITH QUICK APPLIED UNCURED EPDM

- VapAir Seal 725TR
- ROOF MEMBRANE
- BONDING ADHESIVE
- SEE NOTE(S)

DETAIL NO.
TR-15.1B
ADHERED A&V

— AIR / VAPOR CONTROL LAYERS —

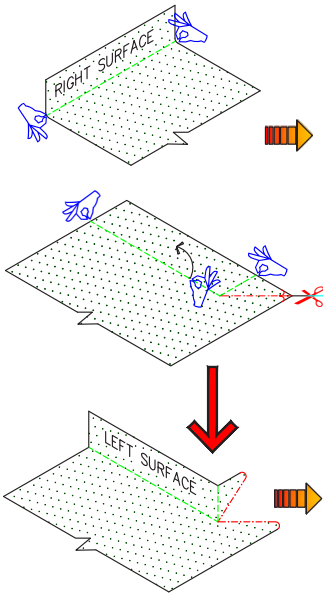

USE ROLLER PRESSURE TO PROPERLY SEAL ALL SURFACES

CLEAN THE DRY SPLICE AREA OF THE VapAir Seal 725TR BY SCRUBBING WITH EPDM PRIMER.

 VapAir Seal 725TR

FOLD LINE 

CUT LINE 

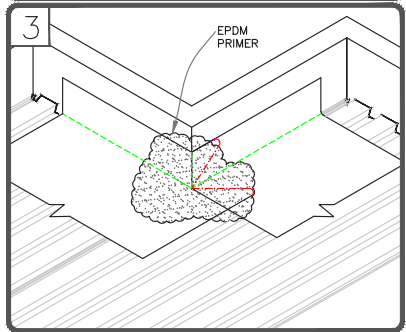
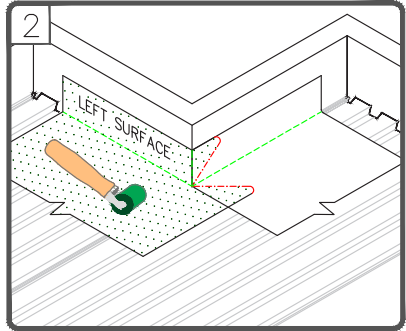
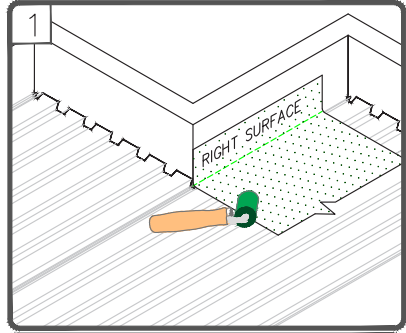



SEE SHEET TR-0 FOR ADDITIONAL INFORMATION.

VapAir Seal 725TR



OUTSIDE CORNER WITH PRE-CUT QUICK APPLIED UNCURED EPDM (PAGE 1 OF 2)

-  → VapAir Seal 725TR
-  → ROOF MEMBRANE
-  → BONDING ADHESIVE
- 1 → SEE NOTE(S)

DETAIL NO.
TR-15.2C
UNISSD 04/19

AIR / VAPOR CONTROL LAYERS

PRIOR TO PLACEMENT OF VERSIGARD CORNER, PEEL OFF THE BLUE POLY RELEASE FILM AND HEAT THE FLASHING SIDE WITH A HEAT GUN. RE-APPLY THE POLY LOOSELY. FOLD THE FLASHING IN HALF.

PLACE VERSIGARD INSIDE/OUTSIDE CORNER AS SHOWN AND REMOVE RELEASE PAPER. PRESS FOLDED FLASHING TIGHTLY INTO ANGLE CHANGE AND FIRMLY PRESS FLASHING AGAINST THE VERTICAL SURFACE.

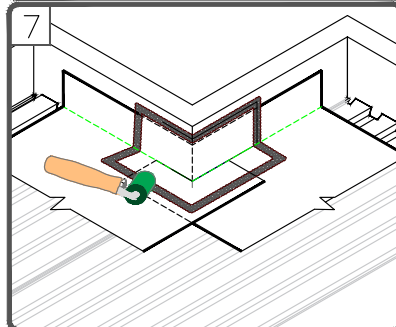
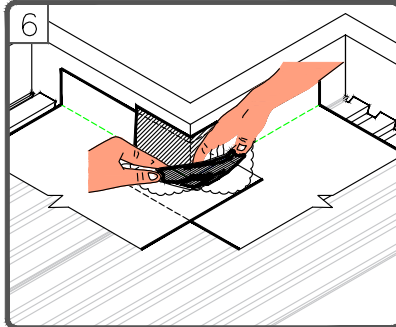
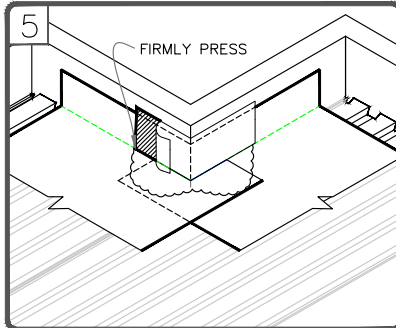
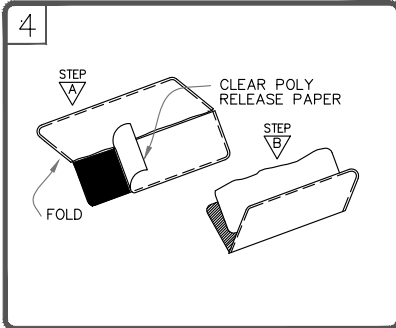

PLACE FOLDED FLASHING TIGHTLY INTO ANGLE CHANGE AND FIRMLY PRESS FLASHING ONTO THE DECK FLANGE BY PRESSING THE FLASHING AGAINST THE HORIZONTAL SURFACE.

ROLL WITH A TWO INCH WIDE ROLLER. PAY PARTICULAR ATTENTION TO THE STEP OFFS AND ANGLE CHANGE.

SEE SHEET TR-0 FOR ADDITIONAL INFORMATION.

VapAir Seal 725TR



OUTSIDE CORNER WITH PRE-CUT QUICK APPLIED UNCURED EPDM (PAGE 2 OF 2)

- VapAir Seal 725TR
- ROOF MEMBRANE
- BONDING ADHESIVE
- 1 → SEE NOTE(S)

TR-15.2C

ADHESION SURF

AIR / VAPOR CONTROL LAYERS

SIDE LAP DETAIL

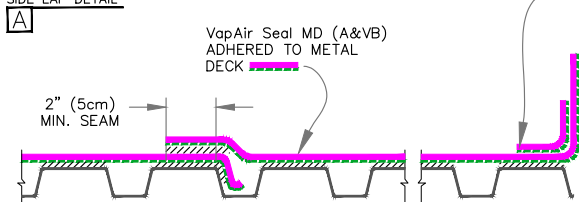

SEE MD-0 PAGE 2 OF 2

3-D END-LAP ASSEMBLY

B

FIRST LAYER OF INSULATION IS REQUIRED TO BE MECHANICALLY FASTENED, EXCEPT FOR BALLASTED ROOF ASSEMBLY

VapAir Seal MD (A&VB) FULLY ADHERED TO STEEL DECK

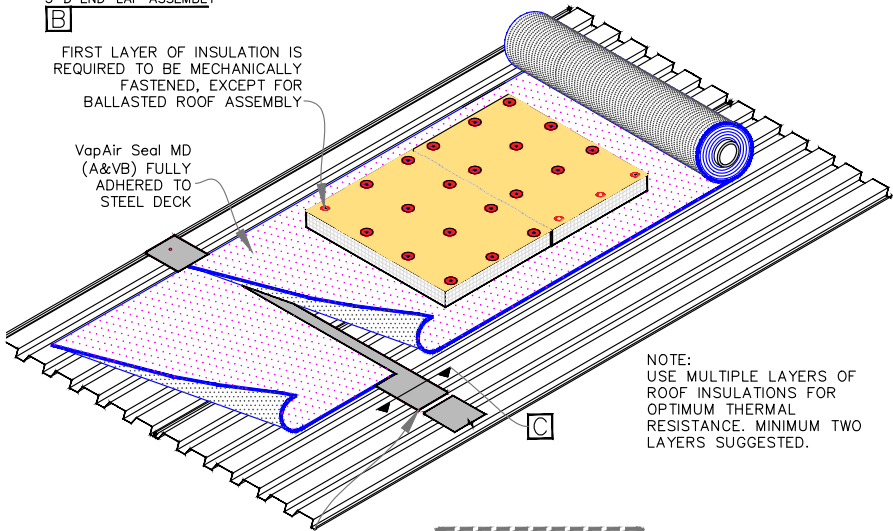

NOTE: USE MULTIPLE LAYERS OF ROOF INSULATIONS FOR OPTIMUM THERMAL RESISTANCE. MINIMUM TWO LAYERS SUGGESTED.

MIN. 4" (10cm) WIDE METAL STRIPS UNDER END LAPS WITH ROUNDED CORNERS, CENTRALLY ALIGNED WITH SEAM ABOVE.

OPTION: CONTRACTOR MAY USE VapAir Seal MD STRIPPING IN LIEU OF SHEET METAL STRIPPING.

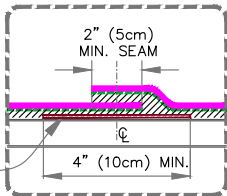





SEAM CROSS-SECTION

SEE MD-0 (PAGE 1 & 2) FOR ADDITIONAL INFORMATION

VapAir Seal MD



INSTALLATION
(PAGE 1 OF 2)

-  → VapAir Seal MD
-  → ROOF MEMBRANE
-  → CAV-GRIP, CCW-702 OR CCW-702LV
-  → SEE NOTE(S)

DETAIL NO.
MD-0
ADHERED A&VB

AIR / VAPOR CONTROL LAYERS

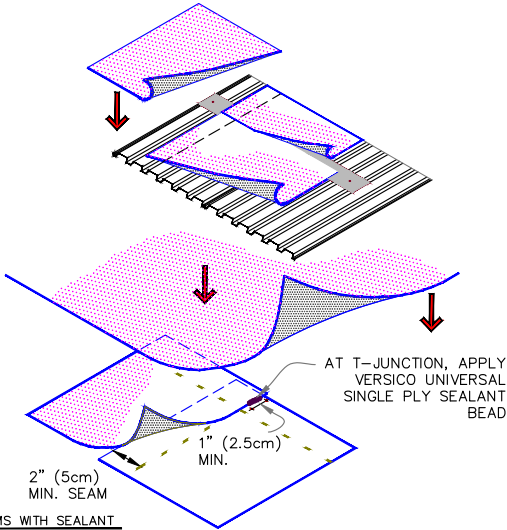

D

NOTES:

1. EXTEND VapAir Seal MD TO TOP EDGE OF ROOF INSULATION OR MIN. 2" (5cm).
2. HAND ROLL VERTICAL SURFACES WITH 2" (5cm) WIDE PRESSURE ROLLER.
3. WHEN VapAir Seal MD HAS TO BE EXTENDED UP THE WALL (TO SEAL WITH EXTERIOR WALL BARRIERS), IT SHOULD BE COVERED WITH INSULATION BOARD (MIN. R-VALUE 6) TO AVOID CONDENSATION AND ALSO TO AVOID UNEQUAL EXPANSION/CONTRACTION OF MEMBRANES. BOARD WILL PROVIDE A SUBSTRATE FOR ROOF MEMBRANE ALSO.
4. DIRECT ADHESION OF ROOF MEMBRANE TO VapAir Seal MD IS NOT RECOMMENDED.

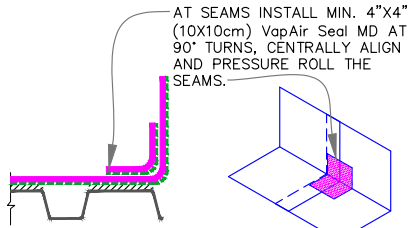

ROOF TO WALL TRANSITION

E

SEE MD-0 (PAGE 1 & 2) FOR ADDITIONAL INFORMATION

VapAir Seal MD



INSTALLATION
(PAGE 2 OF 2)

- VapAir Seal MD
- ROOF MEMBRANE
- CAV-GRIP, CCW-702 OR CCW-702LV
- 1 → SEE NOTE(S)

DETAIL NO.

MD-0

ADHERED A&B

AIR / VAPOR CONTROL LAYERS

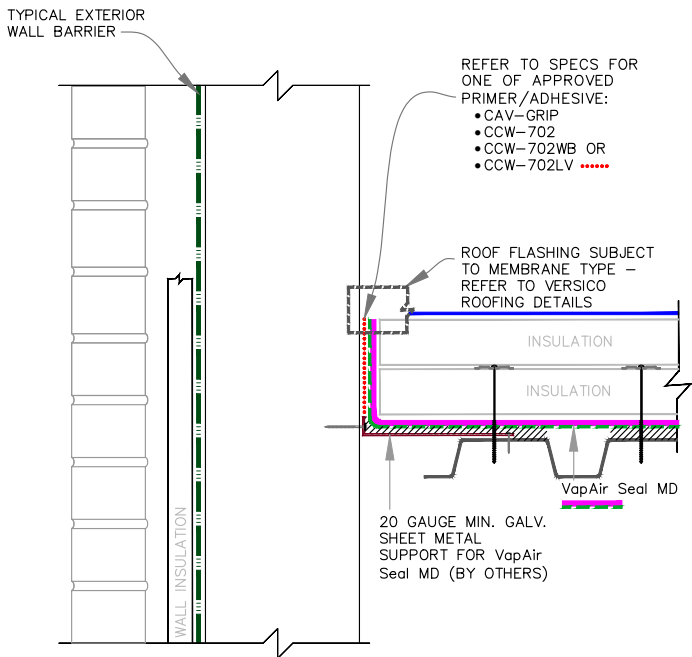

SEE MD-0 (PAGE 1 & 2) FOR ADDITIONAL INFORMATION

VapAir Seal MD



PARAPET (NO TIE-IN TO WALL VAPOR BARRIER)

- VapAir Seal MD
- ROOF MEMBRANE
- CAV-GRIP, CCW-702 OR CCW-702LV
- SEE NOTE(S)

1

DETAIL NO.

MD-1.1

ADHERED A&V

AIR / VAPOR CONTROL LAYERS

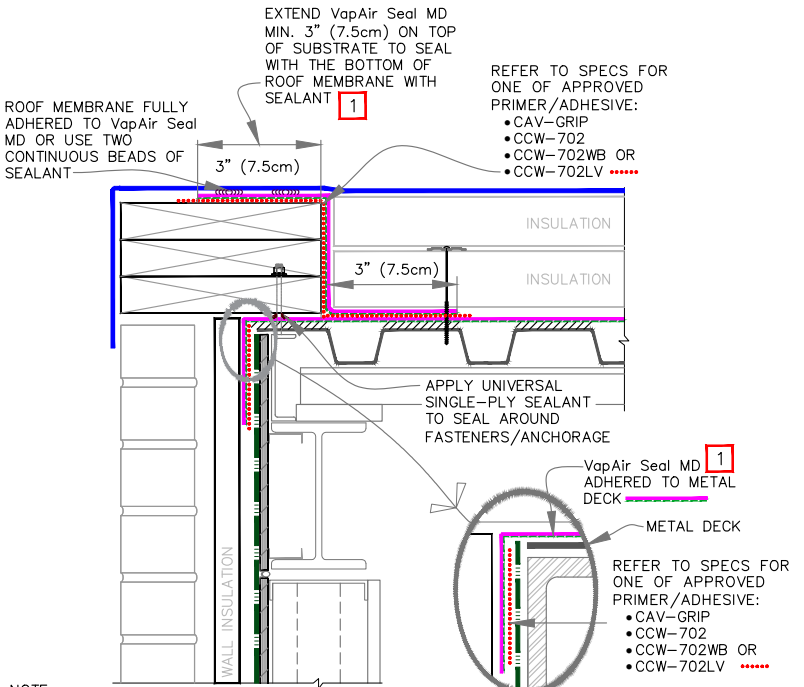

NOTE

- 1. OPTION: CONTRACTOR MAY USE ELASTOFROM FLASHING IN LIEU OF VapAir Seal MD.

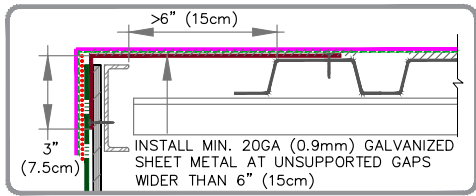

SEE MD-0 (PAGE 1 & 2) FOR ADDITIONAL INFORMATION

VapAir Seal MD



ROOF EDGE: ROOF A&VB TIE-IN TO WALL A&VB

- VapAir Seal MD
- ROOF MEMBRANE
- CAV-GRIP, CCW-702 OR CCW-702LV
- 1 → SEE NOTE(S)

DETAIL NO.
MD-1.2
ADHERED A&VB

AIR / VAPOR CONTROL LAYERS

WALL'S A&VB OVERLAPS
MIN. 3" (7.5cm) IN
SHINGLED OR
NON-SHINGLED FASHION
PER MANUFACTURER'S
INSTRUCTION

REFER TO SPECS FOR
ONE OF APPROVED
PRIMER/ADHESIVE:
• CAV-GRIP
• CCW-702
• CCW-702WB OR
• CCW-702LV

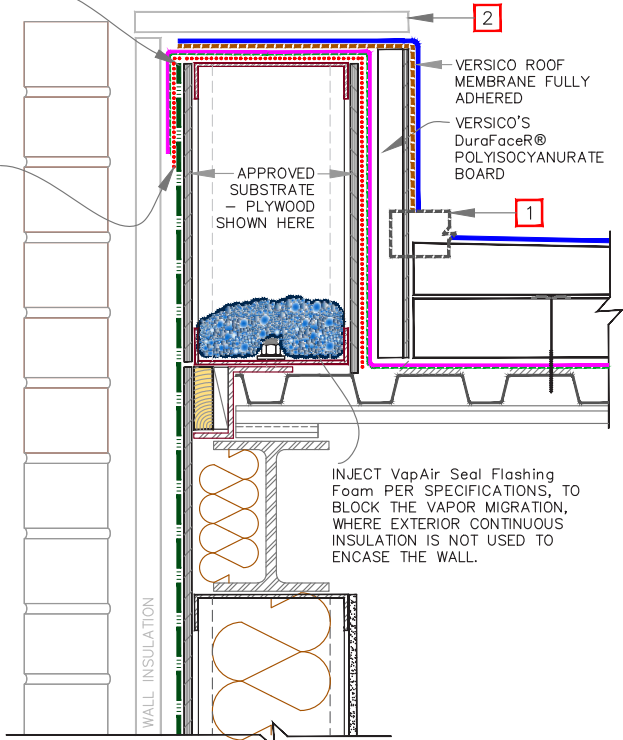

NOTES:

1. REFER TO VERSICO STANDARD DETAILS FOR ROOF BASE FLASHING
2. VERSICO SECURSHIELD HD COMPOSITE BOARD, 100 PSI (6.9 KILOPASCAL) COMPRESSIVE STRENGTH [SUGGESTED IN ASHRAE ZONES 6-8 (ZONES B TO D IN CANADA)] OR WHERE CODE REQUIRES FOR c.i. (CONTINUOUS INSULATION).

SEE MD-0 (PAGE 1 & 2) FOR ADDITIONAL INFORMATION

VapAir Seal MD



PARAPET ON ROOF DECK
ROOF A&VB TIE-IN TO
WALL A&VB

- VapAir Seal MD
- ROOF MEMBRANE
- CAV-GRIP, CCW-702 OR CCW-702LV
- SEE NOTE(S)

DETAIL NO.
MD-1.3
ADHERED A&VB

AIR / VAPOR CONTROL LAYERS

WALL'S A&VB OVERLAPS
MIN. 3" (7.5cm) IN
SHINGLED OR
NON-SHINGLED FASHION
PER MANUFACTURER'S
INSTRUCTION

REFER TO SPECS FOR
ONE OF APPROVED
PRIMER/ADHESIVE:
• CAV-GRIP
• CCW-702
• CCW-702WB OR
• CCW-702LV

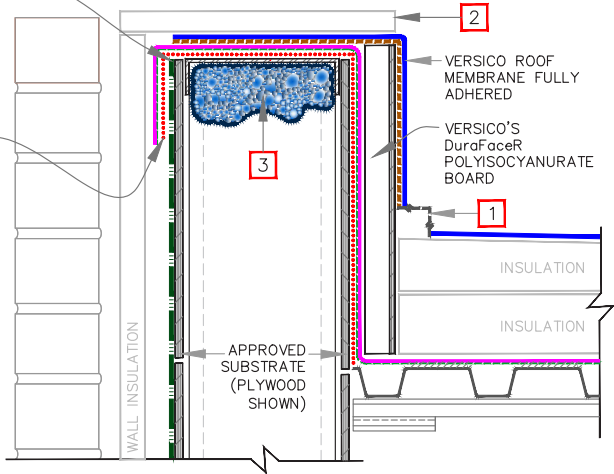

NOTES:

1. REFER TO VERSICO STANDARD DETAILS FOR ROOF BASE FLASHING
2. VERSICO SECURSHIELD HD COMPOSITE BOARD, 100 PSI (6.9 KILOPASCAL) COMPRESSIVE STRENGTH [SUGGESTED IN ASHRAE ZONES 6-8 (ZONES B TO D IN CANADA)] OR WHERE CODE REQUIRES FOR c.i. (CONTINUOUS INSULATION).
3. IN HIGH HUMIDITY SPACES, USE VapAir Seal Flashing Foam PER SPECIFICATIONS [SUGGESTED IN ASHRAE ZONES 6-8 (ZONES B-D IN CANADA)]

SEE MD-0 (PAGE 1 & 2) FOR ADDITIONAL INFORMATION

VapAir Seal MD



PARAPET
(CONTINUOUS WALL)
ROOF A&VB TIE-IN TO
WALL A&VB

- VapAir Seal MD
- ROOF MEMBRANE
- CAV-GRIP, CCW-702 OR CCW-702LV
- 1 → SEE NOTE(S)

DETAIL NO.

MD-1.4

ADHERED A&VB

■ AIR / VAPOR CONTROL LAYERS ■

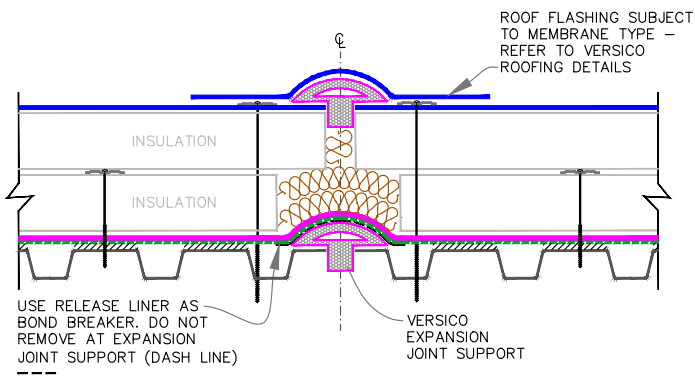

A OPTION A

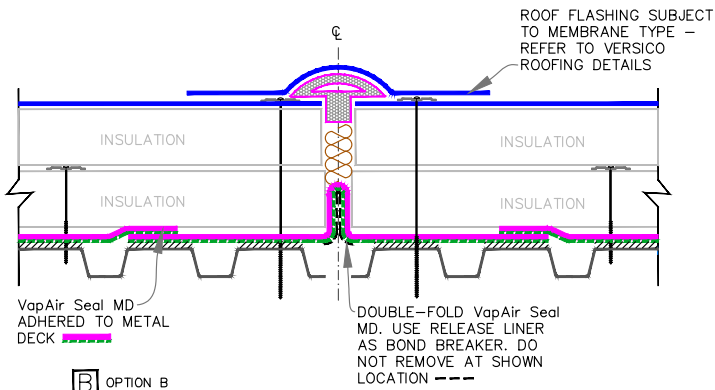

B OPTION B

SEE MD-0 (PAGE 1 & 2) FOR ADDITIONAL INFORMATION

VapAir Seal MD



ROOF EXPANSION JOINT (ROOF-TO-ROOF JOINT)

- VapAir Seal MD
- ROOF MEMBRANE
- CAV-CRIP, CCW-702 OR CCW-702LV
- SEE NOTE(S)

DETAIL NO.
MD-3.1
ADHERED A&VR

AIR / VAPOR CONTROL LAYERS

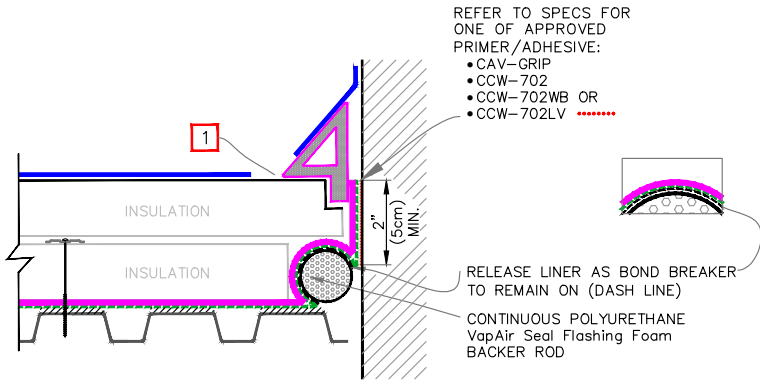

NOTE

1. REFER TO TYPICAL EXPANSION JOINT DETAIL FOR SELECTED ROOF ASSEMBLY TYPE.

B OPTION B

SEE MD-0 (PAGE 1 & 2) FOR ADDITIONAL INFORMATION

VapAir Seal MD



<p>ROOF EXPANSION JOINT (ROOF-TO-WALL JOINT)</p>	<p>→ VapAir Seal MD → ROOF MEMBRANE → CAV-GRIP, CCW-702 → OR CCW-702LV 1 → SEE NOTE(S)</p>
------------------------------------------------------	------------------------------------------------------------------------------------------------------------

<p>DETAIL NO. MD-3.2</p> <p>ADHERED A&B</p>

AIR / VAPOR CONTROL LAYERS

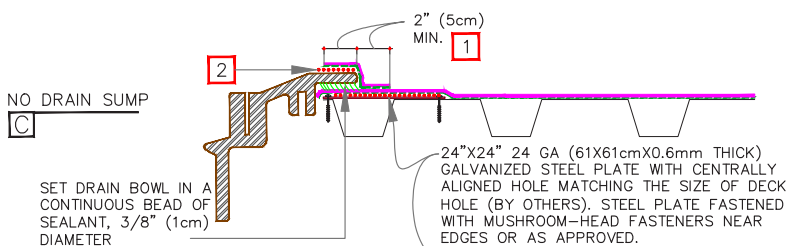
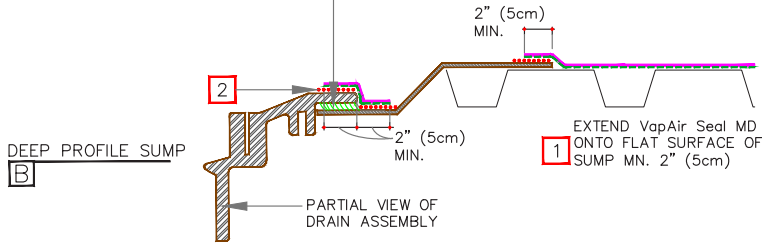
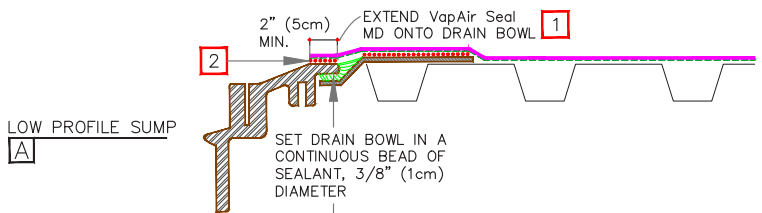

NOTES

1. HAND ROLL WITH 2" (5cm) WIDE PRESSURE-ROLLER & ENSURE ANY FISH-MOUTHS ARE SEALED WITH SEALANT.
2. USE PRIMER IF SURFACES ARE RUSTY/UNCLEAN/POOR ADHESION IS EXPERIENCED. VapAir Seal MD ADHERED TO METAL DECK AND STEEL PLATE.
3. CAREFULLY CUT HOLE IN VapAir Seal MD ALIGNED TO DECK HOLE.
4. ENSURE HOLES ARE OPEN BEFORE THE END OF THE DAY OR PRIOR TO RAIN.

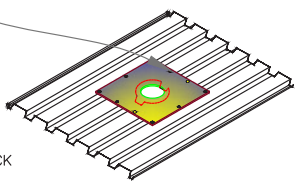

SEE MD-0 (PAGE 1 & 2) FOR ADDITIONAL INFORMATION

VapAir Seal MD



ROOF DRAIN WITH VARYING SUMP CONDITIONS

- VapAir Seal MD
- ROOF MEMBRANE
- CAV-GRIP, CCW-702 OR CCW-702LV
- 1 → SEE NOTE(S)

DETAIL NO. MD-6.1

ADHERED: A&V

AIR / VAPOR CONTROL LAYERS

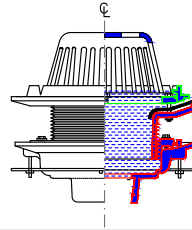
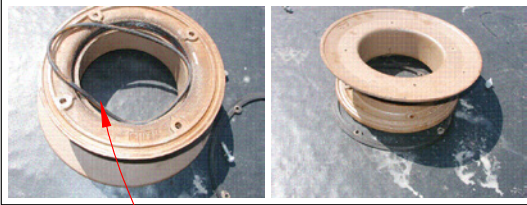

EXAMPLE OF ADJUSTABLE DRAIN - TYPE A

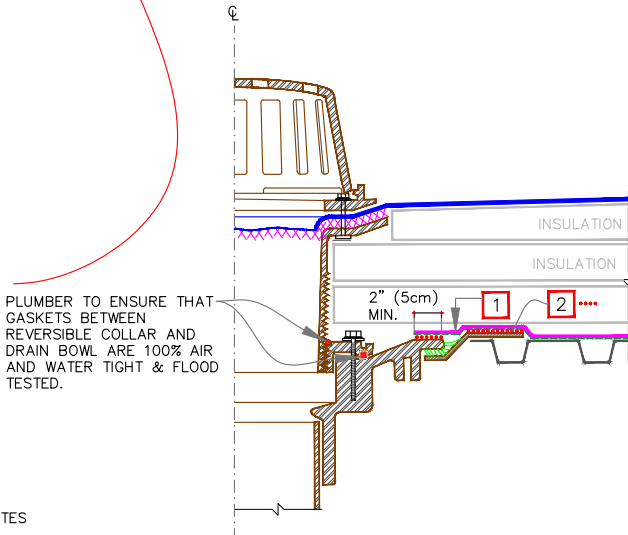

NOTES

1. EXTEND VapAir Seal MD ONTO DRAIN'S FLAT AREA AND HAND ROLL WITH 2" (5cm) WIDE PRESSURE-ROLLER & ENSURE ANY FISH-MOUTHS ARE SEALED WITH SEALANT
2. USE PRIMER IF SURFACES ARE RUSTY/UNCLEAN/POOR ADHESION IS EXPERIENCED.

SEE MD-0 (PAGE 1 & 2) FOR ADDITIONAL INFORMATION

VapAir Seal MD



ROOF DRAIN WITH ADJUSTABLE HEIGHT - TYPE A

- VapAir Seal MD
- ROOF MEMBRANE
- CAV-GRIP - CCW-702 OR CCW-702LV
- SEE NOTE(S)

DETAIL NO.

MD-6.2

ADHERED A&B

AIR / VAPOR CONTROL LAYERS

EXAMPLE OF ADJUSTABLE DRAIN - TYPE B

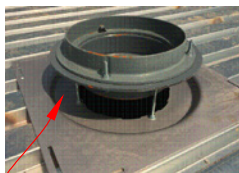

VOID UNDER DRAIN FILLED WITH RIGID BOARD INSULATION AND SET IN CONSTRUCTION ADHESIVE. BUILD SQUARE CURB AROUND THE DRAIN.

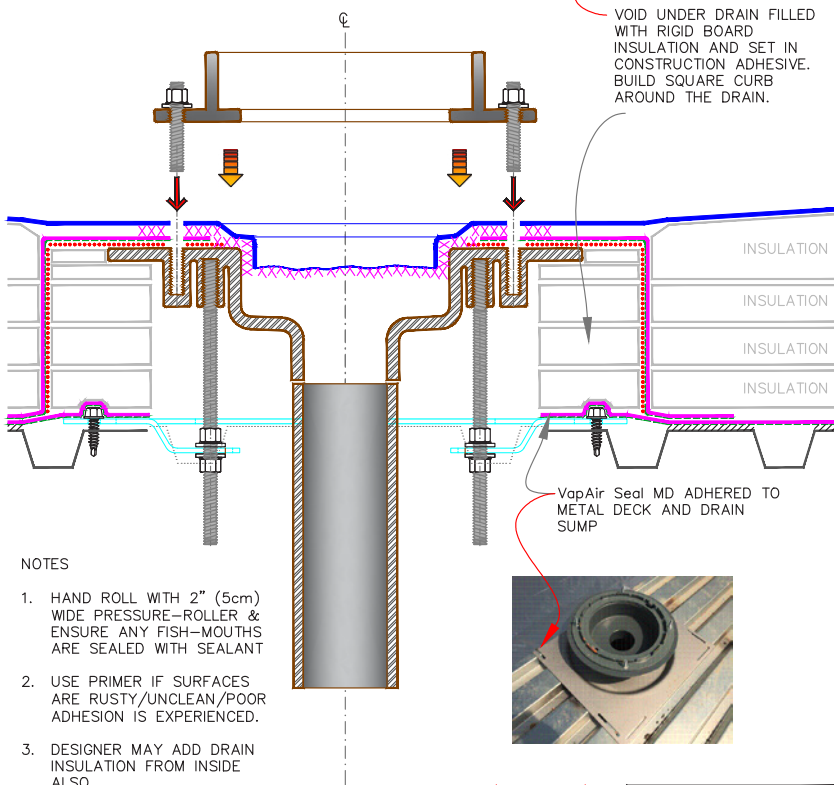

VapAir Seal MD ADHERED TO METAL DECK AND DRAIN SUMP

NOTES

1. HAND ROLL WITH 2" (5cm) WIDE PRESSURE-ROLLER & ENSURE ANY FISH-MOUTHS ARE SEALED WITH SEALANT
2. USE PRIMER IF SURFACES ARE RUSTY/UNCLEAN/POOR ADHESION IS EXPERIENCED.
3. DESIGNER MAY ADD DRAIN INSULATION FROM INSIDE ALSO.

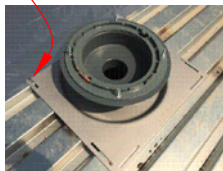

SEE MD-0 (PAGE 1 & 2) FOR ADDITIONAL INFORMATION

VapAir Seal MD



ROOF DRAIN WITH ADJUSTABLE HEIGHT - TYPE B

- VapAir Seal MD
- ROOF MEMBRANE
- CAV-GRIP, CCW-702 OR CCW-702LV
- SEE NOTE(S)

DETAIL NO.
MD-6.3
ADHERED A&V

AIR / VAPOR CONTROL LAYERS

NOTE: REFER TO [DETAIL_MD-8.3](#), WHERE MULTIPLE PENETRATIONS EXIST IN ONE AREA

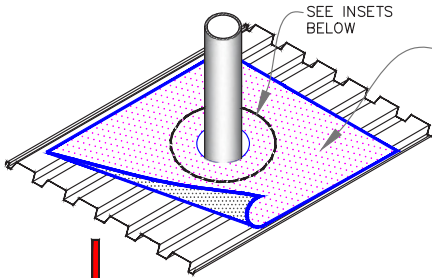

PROPERLY MARK A REQUIRED SIZE HOLE IN VapAir Seal MD AND CUT IT IN CIRCLE FOR ROUND PENETRATIONS AND FULLY ADHERE IT.

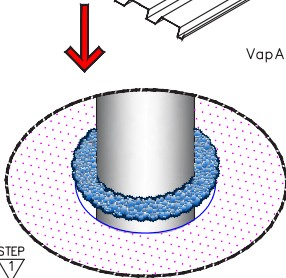

STEP 1

CLEAN THE RECEIVING SURFACES OF PIPE & VapAir Seal MD. SPRAY APPLY VapAir Seal Flashing Foam PER SPECIFICATIONS ONTO THE SURFACE OF PIPE MAKING A COMPLETE LOOP AROUND THE PENETRATION AND LET THE VapAir Seal Flashing Foam EXPAND AND DRY

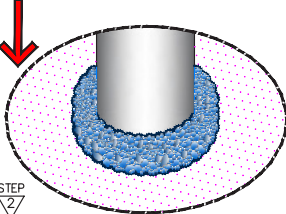

STEP 2

SPRAY APPLY 2ND LAYER OF VapAir Seal Flashing Foam ONTO THE SOLIDIFIED SURFACE OF FIRST LAYER, MAKING A COMPLETE LOOP ENSURING BOTH THE LAYERS ARE ADJOINING TOGETHER, MAKING A PROPER AIR SEAL BETWEEN PIPE AND VapAir Seal MD.

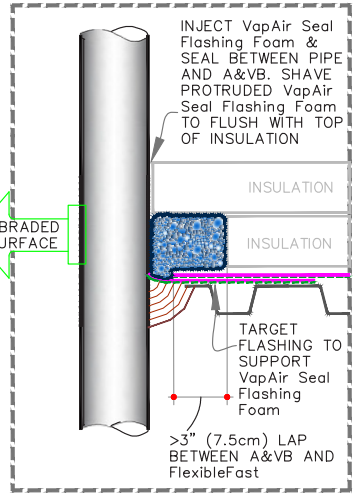
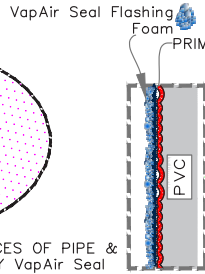



NOTE: ON PVC PIPES / PVC SUBSTRATES, ACHIEVE AN ABRADED SURFACE BY GRINDING WITH COARSE SANDPAPER OR POWERED WIRE BRUSH TO ENHANCE THE ADHESION. APPLY CAV-GRIP PRIMER TO ABRADED SURFACE & A&VB

SEE [MD-0 \(PAGE 1 & 2\)](#) FOR ADDITIONAL INFORMATION

VapAir Seal MD



PIPE SEALED WITH VapAir Seal Flashing Foam PER SPECIFICATIONS

-  → VapAir Seal MD
-  → ROOF MEMBRANE
-  → CAV-GRIP, CCW-702 OR CCW-702LV
-  → SEE NOTE(S)

DETAIL NO.
MD-8.1
ADHERED A&VB

AIR / VAPOR CONTROL LAYERS

NOTE: REFER TO [DETAIL_MD-8.3](#), WHERE MULTIPLE PENETRATIONS EXIST IN ONE AREA

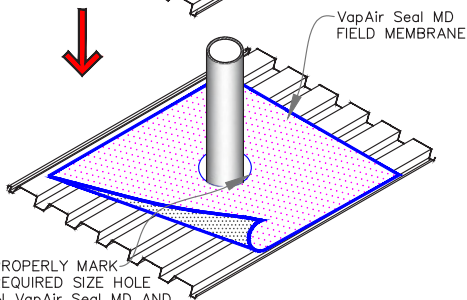
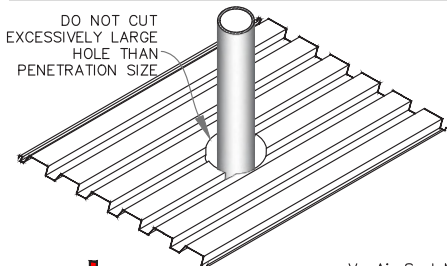

PROPERLY MARK REQUIRED SIZE HOLE IN VapAir Seal MD AND CUT A HOLE CLOSER TO THE PENETRATION. FOR ROUND PENETRATIONS CUT A CIRCULAR HOLE

1 QUICK APPLIED UNCURED EPDM FLASHING IN CONJUNCTION WITH EPDM PRIMER.

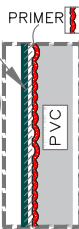
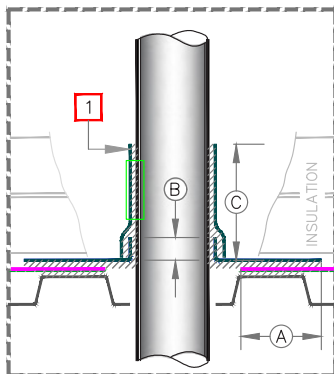

DIMENSIONS	cm
(A)	3" 7.5 MIN.
(B)	1/2" 1.5 MIN.
(C)	MIN. 3" (7.5cm) OR MAX. BELOW THE HEIGHT OF INSULATION

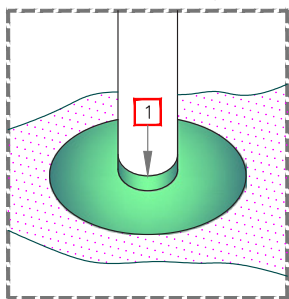

NOTE: ON PVC PIPES / PVC SUBSTRATES, ACHIEVE AN ABRADED SURFACE BY GRINDING WITH COARSE SANDPAPER OR POWERED WIRE BRUSH TO ENHANCE THE ADHESION. APPLY CAV-GRIP PRIMER TO ABRADED SURFACE & A&VB

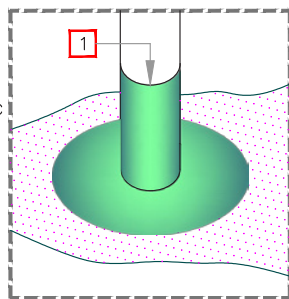

SEE [MD-0 \(PAGE 1 & 2\)](#) FOR ADDITIONAL INFORMATION

VapAir Seal MD



PIPE
QUICK APPLIED UNCURED EPDM FLASHINGS

- VapAir Seal MD
- ROOF MEMBRANE
- CAV-GRIP, CCW-702 OR CCW-702LV
- 1 → SEE NOTE(S)

DETAIL NO.
MD-8.2
ADHERED A&VB

AIR / VAPOR CONTROL LAYERS

DIMENSIONS		cm	
A	1/2"	1.5	TO
	1"	2.5	

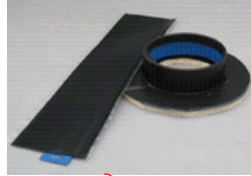

REFER TO VERSICO'S COMMON DETAILS # 16 SERIES FOR APPLICABLE ROOF MEMBRANE SYSTEM

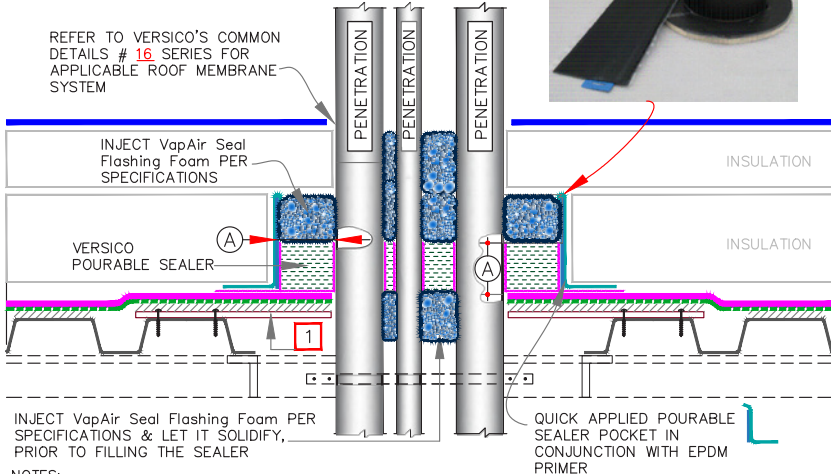

INJECT VapAir Seal Flashing Foam PER SPECIFICATIONS & LET IT SOLIDIFY, PRIOR TO FILLING THE SEALER

QUICK APPLIED POURABLE SEALER IN CONJUNCTION POCKET IN CONJUNCTION WITH EPDM PRIMER

NOTES:

1. THE MAXIMUM ALLOWABLE SURFACE TEMPERATURE OF THE PENETRATION SHALL NOT EXCEED 180° F (82° C).
2. PENETRATIONS, AIR & VAPOR BARRIER, FLASHING AND METAL (INSIDE POCKET) MUST BE PRIMED WITH EPDM PRIMER PRIOR TO APPLYING POURABLE SEALER. DO NOT PRIME THE BLUE PLASTIC SUPPORT STRIP.
3. POURABLE SEALER MUST CONTACT PRIMED QUICK APPLIED UNCURD FLASHING AND AIR & VAPOR BARRIER.
4. SECUREMENT IS REQUIRED FOR POURABLE SEALER POCKETS WHICH ARE GREATER THAN 18" (46cm) IN DIAMETER. REFER TO SPECIFICATIONS.
5. PIPE CLUSTERS MUST HAVE MINIMUM 1" (2.5cm) CLEARANCE BETWEEN PENETRATIONS.
6. 22 GAUGE STEEL STRIPS TO FILL GAPS & SUPPORT THE SEALER POCKET. FASTEN INTO DECK

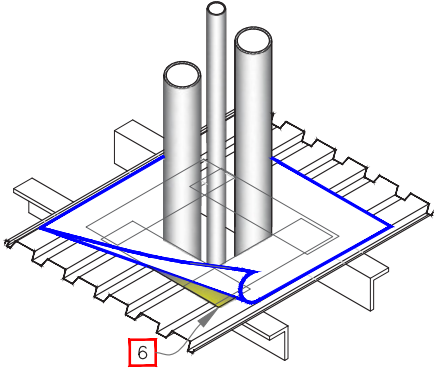

SEE MD-0 (PAGE 1 & 2) FOR ADDITIONAL INFORMATION

VapAir Seal MD



MULTIPLE PENETRATIONS' FLASHINGS IN GROUP

- VapAir Seal MD
- ROOF MEMBRANE
- CAV-GRIP, CCW-702 OR CCW-702LV
- SEE NOTE(S)

DETAIL NO.
MD-8.3
ADHERED A&VP

AIR / VAPOR CONTROL LAYERS

NOTE: REFER TO [DETAIL_MD-8.3](#), WHERE MULTIPLE PENETRATIONS EXIST IN ONE AREA

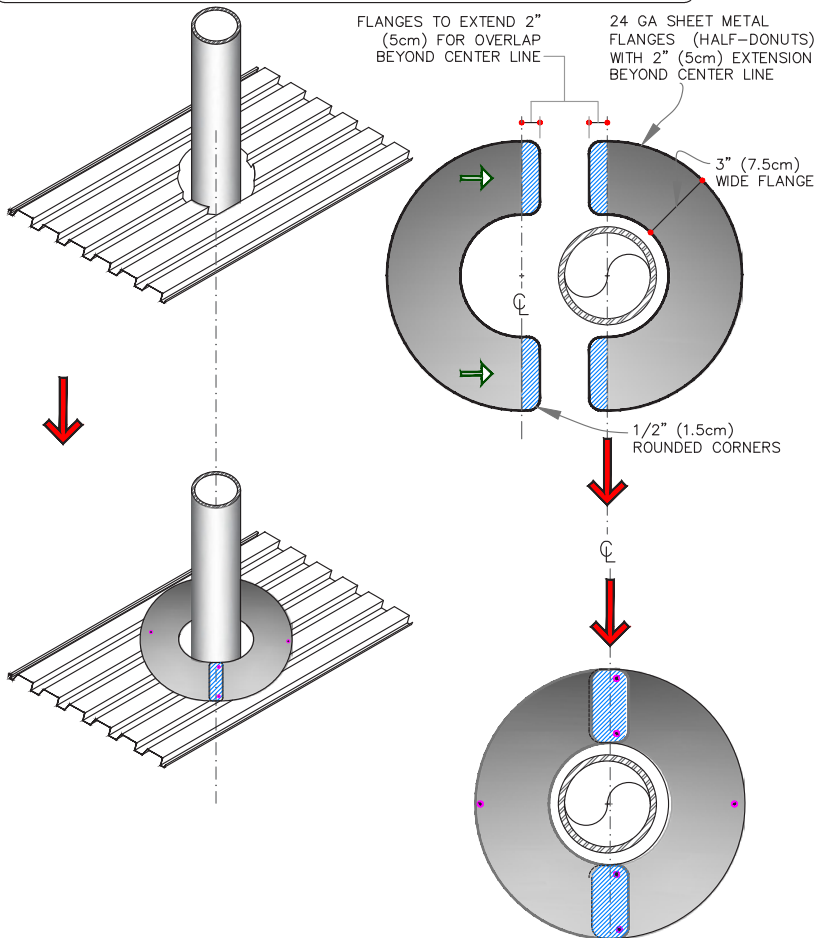





SEE [MD-0 \(PAGE 1 & 2\)](#) FOR ADDITIONAL INFORMATION

VapAir Seal MD



PIPE SHEET METAL FLANGES TO SUPPORT FLASHING

-  → VapAir Seal MD
-  → ROOF MEMBRANE
-  → CAV-CRIP, CCW-702 OR CCW-702LV
-  → SEE NOTE(S)

DETAIL NO.
MD-8.4
ADHERED A&VR

AIR / VAPOR CONTROL LAYERS

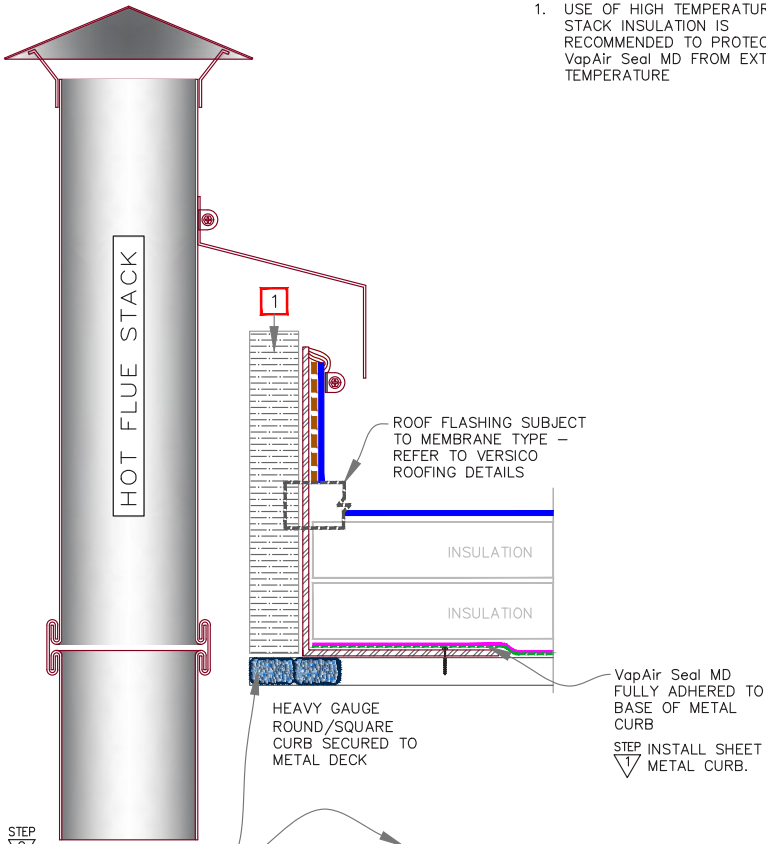

NOTE
 1. USE OF HIGH TEMPERATURE STACK INSULATION IS RECOMMENDED TO PROTECT VapAir Seal MD FROM EXTREME TEMPERATURE

STEP 2

FILL THE BOTTOM FLUTES WITH VapAir Seal Flashing Foam PER SPECIFICATIONS TO AVOID THE MIGRATION OF HUMID AIR, STEAM, OR HOT GASES LEAKING FROM ADJACENT FLUE.

SEE MD-0 (PAGE 1 & 2) FOR ADDITIONAL INFORMATION

VapAir Seal MD



HOT VENT STACK WITH METAL CURB AT DECK

- VapAir Seal MD
- ROOF MEMBRANE
- CAV-GRIP, CCW-702 OR CCW-702LV
- 1 → SEE NOTE(S)

DETAIL NO.
MD-8.6A
 ADHERED A&V

AIR / VAPOR CONTROL LAYERS

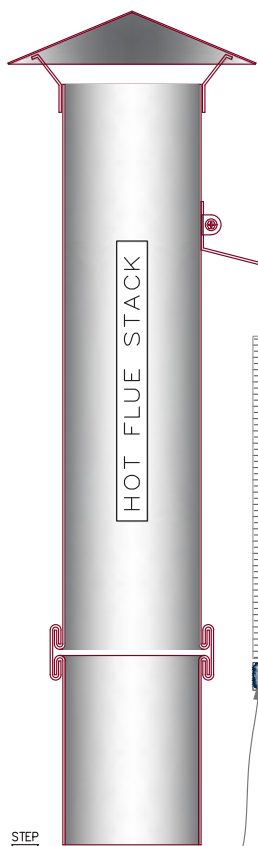

NOTE
 1. USE OF HIGH TEMPERATURE STACK INSULATION IS RECOMMENDED TO PROTECT VapAir Seal MD FROM EXTREME TEMPERATURE

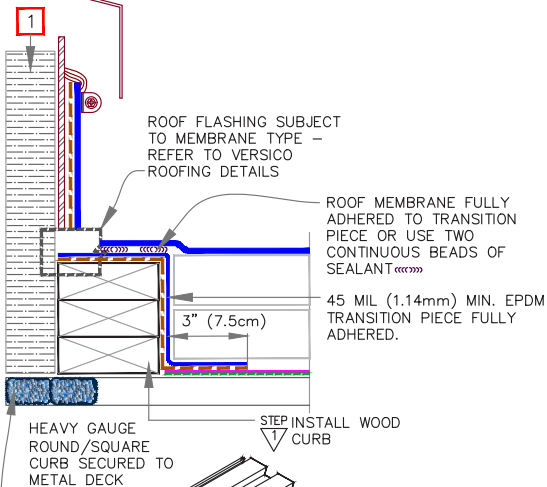

STEP 2
 FILL THE BOTTOM FLUTES WITH VapAir Seal Flashing Foam PER SPECIFICATIONS TO AVOID THE MIGRATION OF HUMID AIR, STEAM, OR HOT GASES LEAKING FROM ADJACENT FLUE.

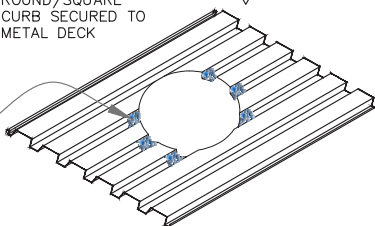

SEE MD-0 (PAGE 1 & 2) FOR ADDITIONAL INFORMATION

VapAir Seal MD



HOT VENT STACK WITH WOOD CURB

- VapAir Seal MD
- ROOF MEMBRANE
- CAV-GRIP, CCW-702 OR CCW-702LV
- 1 → SEE NOTE(S)

DETAIL NO.
 MD-8.6B
 ADHERED A&V/R

AIR / VAPOR CONTROL LAYERS

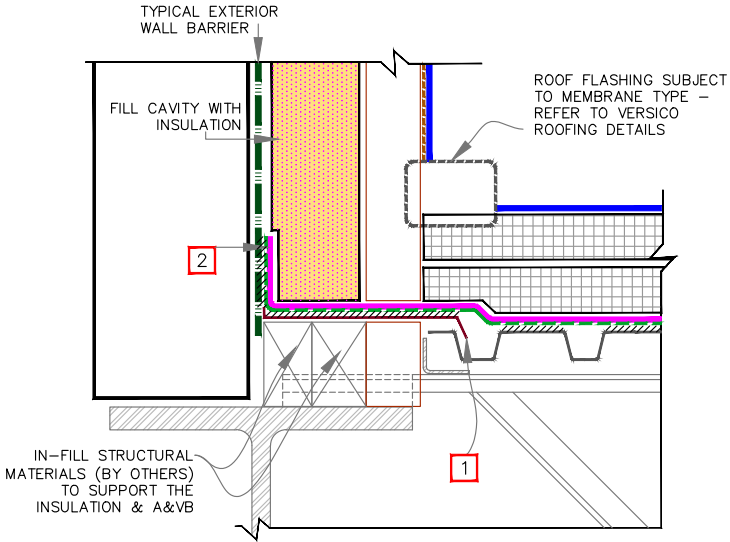
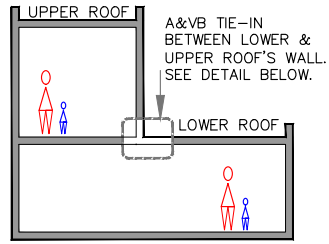

NOTES:





1. SET THRU-WALL STAINLESS STEEL STRIP FLASHING AND EXTEND IT OUT MIN. 3" (7.5cm) (BY OTHERS).
2. EXTEND VapAir Seal MD MIN. 6" (15cm) VERTICAL AND FULLY ADHERE TO WALL'S A&VB. WHEN WALL'S A&VB IS NOT INSTALLED YET, THEN ADHERE TO WALL. WALL BARRIER SHALL BE FULLY ADHERED TO VapAir Seal MD

SEE MD-0 (PAGE 1 & 2) FOR ADDITIONAL INFORMATION

VapAir Seal MD



TIE-IN TO UPPER STOREY WALL

-  → VapAir Seal MD
-  → ROOF MEMBRANE
-  → CAV-GRIP, CCW-702 OR CCW-702LV
-  → SEE NOTE(S)

DETAIL NO.
MD-12.1
ADHERED A&VB

AIR / VAPOR CONTROL LAYERS

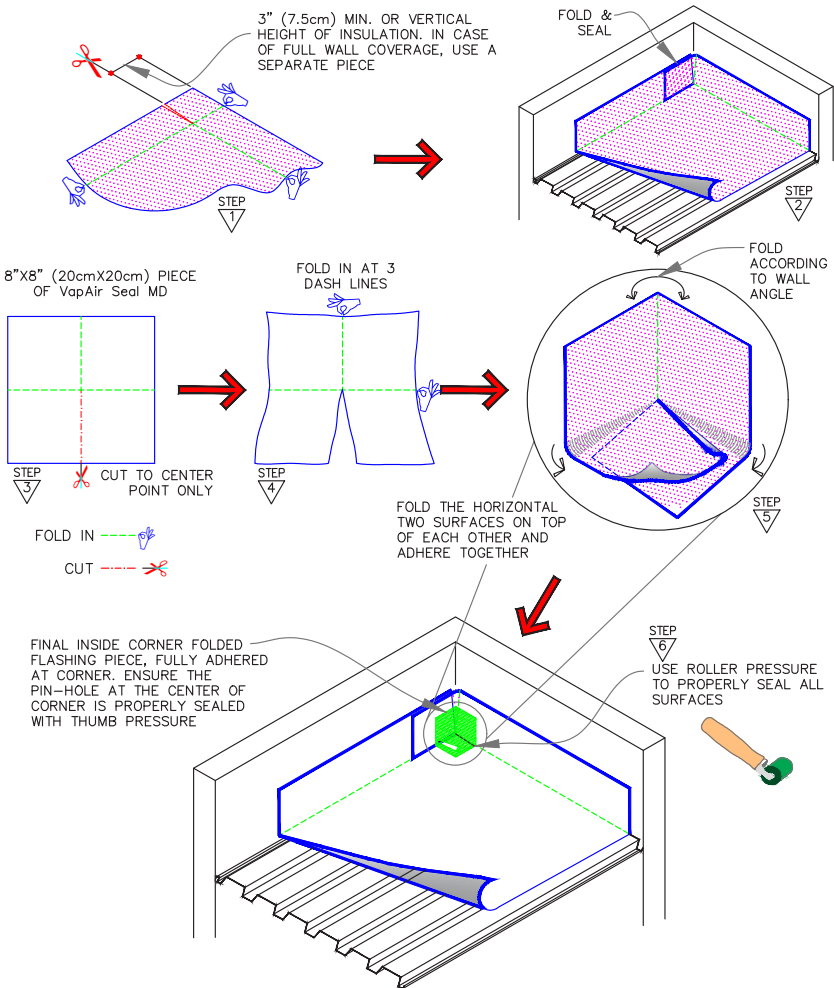

SEE MD-0 (PAGE 1 & 2) FOR ADDITIONAL INFORMATION

VapAir Seal MD



INSIDE CORNER WITH VapAir Seal MD PIECE

- VapAir Seal MD
- ROOF MEMBRANE
- CAV-GRIP, CCW-702 OR CCW-702LV
- SEE NOTE(S)

DETAIL NO. MD-15.1A
ADHERED A&V

AIR / VAPOR CONTROL LAYERS

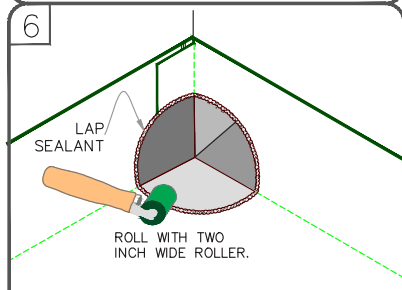
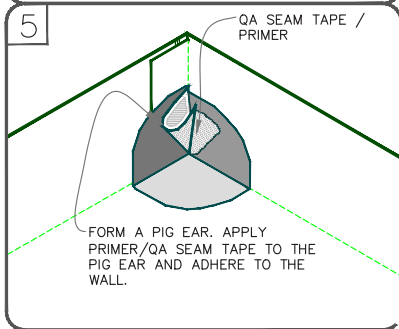
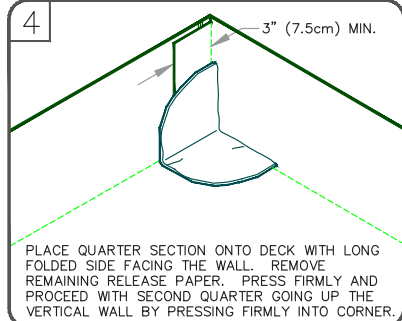
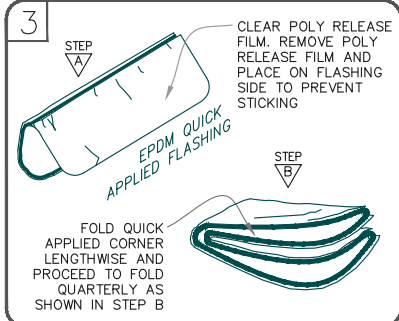
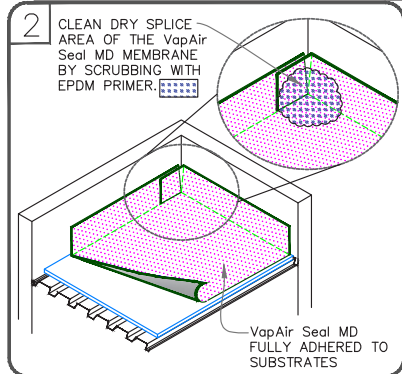
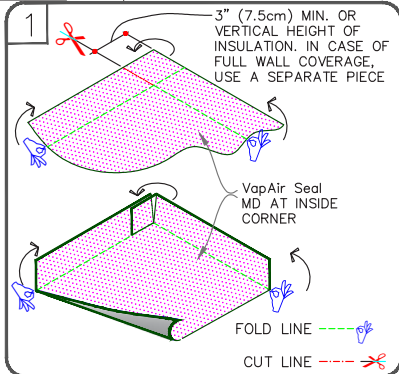

SEE MD-0 (PAGE 1 & 2) FOR ADDITIONAL INFORMATION

VapAir Seal MD



INSIDE CORNER FLASHING WITH QUICK APPLIED UNCURED EPDM FLASHING

- VapAir Seal MD
- ROOF MEMBRANE
- CAV-GRIP, CCW-702 OR CCW-702LV
- SEE NOTE(S)

DETAIL NO.

MD-15.1B

ADHERED A&V

■■■■ AIR / VAPOR CONTROL LAYERS ■■■■

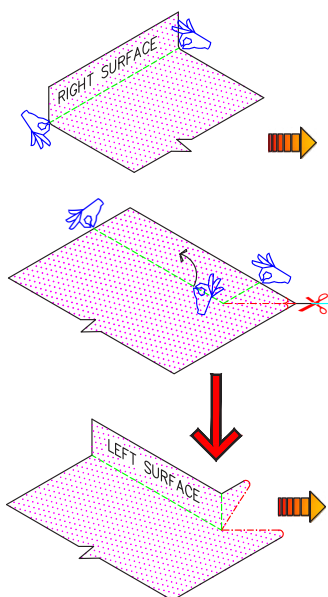

USE ROLLER PRESSURE TO PROPERLY SEAL ALL SURFACES

CLEAN THE DRY SPLICE AREA OF THE VapAir Seal MD BY SCRUBBING WITH EPDM PRIMER.

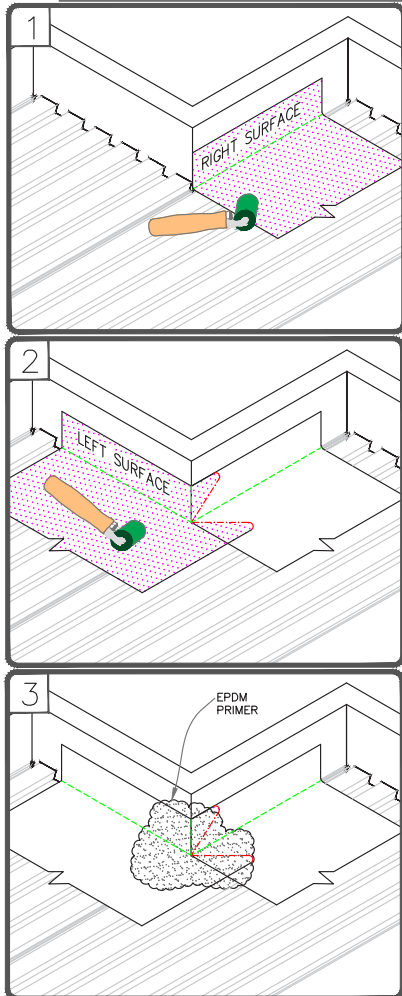
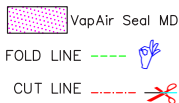

SEE MD-0 (PAGE 1 & 2) FOR ADDITIONAL INFORMATION

VapAir Seal MD



OUTSIDE CORNER WITH PRE-CUT QUICK-APPLIED UNCURED EPDM (PAGE 1 OF 2)	<ul style="list-style-type: none"> → VapAir Seal MD → ROOF MEMBRANE → CAV-GRIP, CCW-702 OR CCW-702LV → SEE NOTE(S)
----------------------------------------------------------------------	--------------------------------------------------------------------------------------------------------------------------------------------------------------

DETAIL NO.	MD-15.2C
ADHERED A&VR	

AIR / VAPOR CONTROL LAYERS

PRIOR TO PLACEMENT OF VERSIGARD CORNER, PEEL OFF THE BLUE POLY RELEASE FILM AND HEAT THE FLASHING SIDE WITH A HEAT GUN. RE-APPLY THE POLY LOOSELY. FOLD THE FLASHING IN HALF.

PLACE VERSIGARD INSIDE/OUTSIDE CORNER AS SHOWN AND REMOVE RELEASE PAPER. PRESS FOLDED FLASHING TIGHTLY INTO ANGLE CHANGE AND FIRMLY PRESS FLASHING AGAINST THE VERTICAL SURFACE.

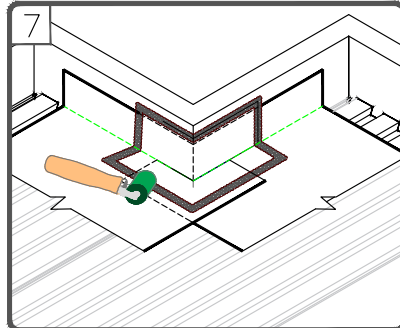
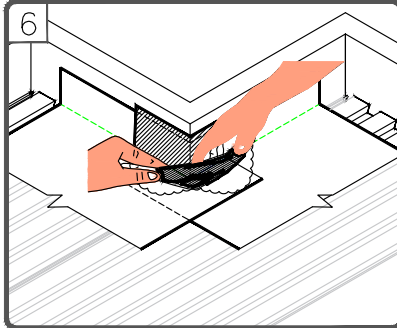
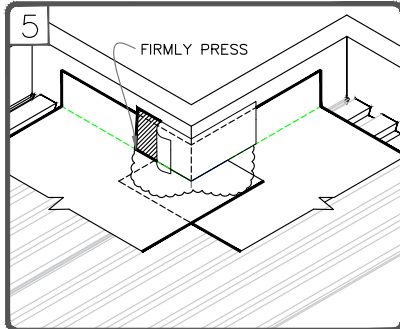
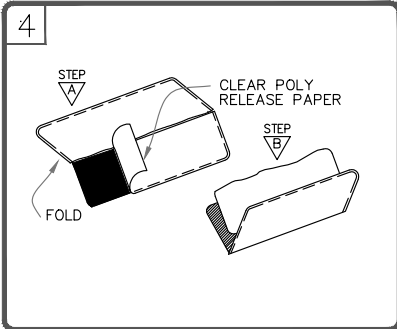

PLACE FOLDED FLASHING TIGHTLY INTO ANGLE CHANGE AND FIRMLY PRESS FLASHING ONTO THE DECK FLANGE BY PRESSING THE FLASHING AGAINST THE HORIZONTAL SURFACE.





ROLL WITH A TWO INCH WIDE ROLLER. PAY PARTICULAR ATTENTION TO THE STEP OFFS AND ANGLE CHANGE.

SEE MD-0 (PAGE 1 & 2) FOR ADDITIONAL INFORMATION

VapAir Seal MD



OUTSIDE CORNER WITH PRE-CUT QUICK-APPLIED UNCURVED EPDM (PAGE 2 OF 2)

-  → VapAir Seal MD
-  → ROOF MEMBRANE
-  → CAV-GRIP, CCW-702 OR CCW-702LV
-  → SEE NOTE(S)



AIR / VAPOR CONTROL LAYERS

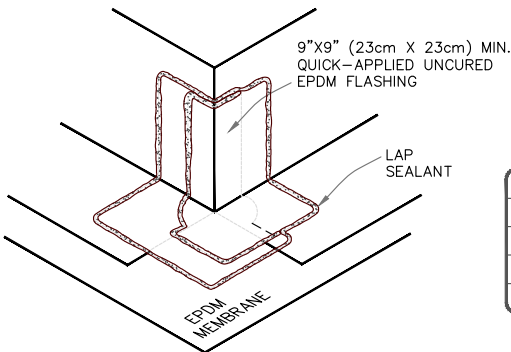

DIMENSIONS	cm	
(A) 6"	15	TO
9"	23	
(B) 2"	5	MIN.
(C) 3"	7.5	MAX.

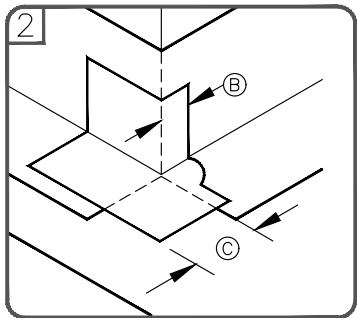
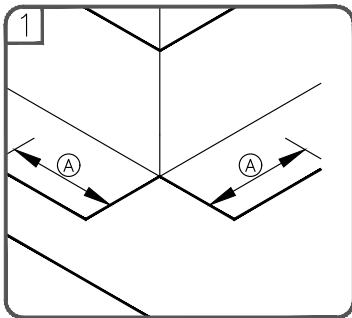

NOTES:





1. APPLY EPDM PRIMER TO THE VapAir Seal MD SURFACES PRIOR TO INSTALLING QUICK-APPLIED FLASHING.
2. QUICK-APPLIED UNCURED EPDM FLASHING TO OVERLAP DECK SURFACE 3" (7.5cm) MINIMUM AND EXTEND 2" (5cm) MINIMUM AROUND CORNERS.
3. IN COLDER TEMPERATURES, A HEAT GUN MUST BE USED WHEN FORMING QUICK-APPLIED UNCURED EPDM FLASHING.

SEE MD-0 (PAGE 1 & 2) FOR ADDITIONAL INFORMATION

VapAir Seal MD



OUTSIDE CORNER WITH QUICK-APPLIED UNCURED EPDM FLASHING - OPTION 1

 → VapAir Seal MD
 → ROOF MEMBRANE
 → CAV-GRIP, CCW-702 OR CCW-702LV
 → SEE NOTE(S)

DETAIL NO.
MD-15.2D
ADHERED A&VR

AIR / VAPOR CONTROL LAYERS

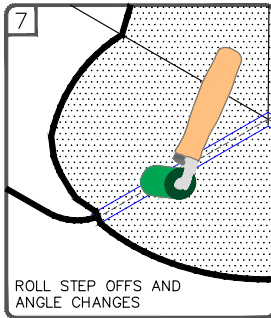
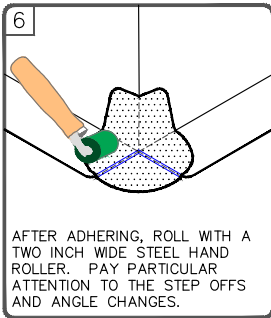
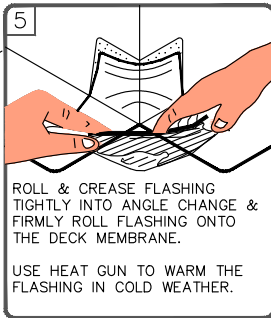
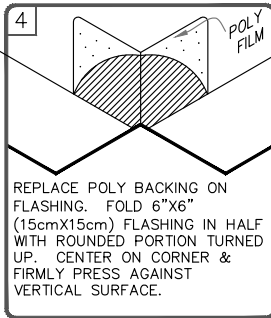
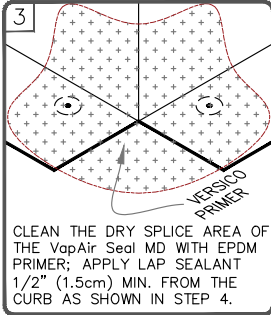
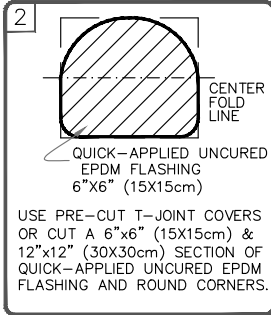
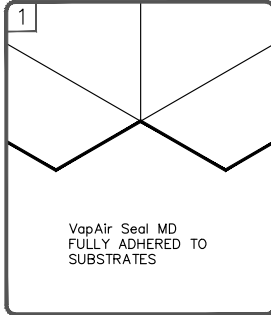

SEE MD-0 (PAGE 1 & 2) FOR ADDITIONAL INFORMATION

VapAir Seal MD



OUTSIDE CORNER WITH QUICK-APPLIED UNCURED EPDM

- VapAir Seal MD
- ROOF MEMBRANE
- CAV-GRIP, CCW-702 OR CCW-702LV
- SEE NOTE(S)

DETAIL NO.

MD-15.2E

ADHERED A&V

SECTION 7: CONTACT INFORMATION

Disclaimer

Versico does not engage in the practice of engineering or architecture; Versico makes no representations as to the structural design or capabilities of the roof or its structural parts.

Versico makes no warranty of fitness for a particular purpose or merchantability and shall not be liable for incidental or consequential damages under any theory of law.

© 2022 Versico. All Rights Reserved.

This manual represents the applicable information available at time of publication. Owners, specifiers, and Versico Authorized Contractors should consult the Versico website for the most up-to-date information. Review the appropriate Versico warranty for specific warranty coverage, terms, conditions, and limitations.

Contact Versico's Special Application Marketing and Product Manager:

Paul Markel
Paul.Markel@Versico.com
800-453-2554 ext. 7484

NOTES



A SINGLE SOURCE FOR SINGLE-PLY ROOFING

800.992.7663 • www.versico.com

Versico, VersiFleece, and DASH are trademarks of Versico. VapAir Seal, CAV-GRIP, and SecurShield are trademarks of Carlisle Construction Materials, LLC. LEED is a registered trademark of the U.S. Green Building Council. SECURROCK is a registered trademark of USG Corporation. DensDeck is a registered trademark of Georgia-Pacific Gypsum LLC.

REPRINT REQUEST CODE: 610353 VE-8938 - "Air & Vapor Barrier Field Guide" © 2022 Versico. Printed in U.S.A. 04.25.22