



THERMOPLASTICS FIELD GUIDE

800-479-6832 • www.carlisesyntec.com



THERMOPLASTICS FIELD GUIDE

FIELD GUIDE PURPOSE

This manual has been developed to serve as a reference guide during the roof installation for Carlisle's approved applicators, quality assurance personnel or anyone involved during the rooftop installation activities. Anyone using the reference guide shall already be familiar with our roofing systems and responsible for actual roof installation.

The following pages include system descriptions, product information, installation procedures, and quality control information to complete a successful TPO or PVC single-ply roof system installation.

**Online Digital
Binder**



DISCLAIMER

This manual is offered as a supplement, not a substitute to the Specification Manual, Safety Data Sheets, or Product Data Sheets.

Please visit Carlisle SynTec Systems website for all the latest product information installation details.

When Installing a Carlisle warranted system, refer to your roof drawing for your project's exact requirements. Should you have questions regarding the roof system, contact information is available in the back of this guide.

TABLE OF CONTENTS

Description of Systems	1
Products & Accessories	
Insulation.....	4
Fasteners & Plates	10
Adhesives, Primers, & Sealants	14
Thermoplastic Accessories	27
Tools & Equipment	33
Common Installation Issues	36
Staging & Storage Best Practices	37
Execution / Installation Procedures	
Sure-Weld® TPO – General.....	39
Sure-Weld TPO – Execution	54
Sure-Flex™ PVC – General	66
Sure-Flex PVC – Execution.....	79
Daily Procedures	93
Insulation Details	99
A-27A Carlisle Insulation / Cover Board Attachment	99
A-27B Minimum 2"-Thick InsulBase® / SecurShield® Polyisocyanurate.....	100
A-27C Minimum 1½"-Thick InsulBase / SecurShield Polyisocyanurate	101
A-27D ¼"- or ½"-Thick SECUROCK® or DensDeck® Prime	102
A-27E ⅝"-Thick SECUROCK or DensDeck Prime	103
A-27F Carlisle StormBase® (OSB/ Polyisocyanurate Composite) Attachment.....	104
A-27G Insulation / Cover Board Attachment Using Bead Adhesive	105
MF-27 Insulation / Cover Board Attachment For All Warranty Durations	106
MF-27C R-Tech® Fanfold Roof Underlayment	107
MF-27D R-Tech Fanfold Roof Underlayment for FM Assemblies	108
MF-27E Insulation/Coverboard Attachment When Using SecurShield Family Products for All Warranties Lengths.....	109
Main Details	110
Mechanically Fastened Details	
MF-2 Membrane Securement	110
MF-2.1 TPO Membrane Securement with Pressure-Sensitive RUSS	111
MF-2A Mechanically Fastened Membrane Splice	112
MF-2B Fastener and Plate Placement	113
MF-22 Ridge Membrane Attachment	114
Metal Edges and Gravel Stops	
U-1A SecurSeal Drip Edge Fascia	115
U-1B SecurWeld® Coated Drip Edge Fascia	116
U-1C Metal Bar Edge Termination	117
U-1D Carlisle SecurEdge™ 200	118
U-1E Carlisle SecurEdge 300	119
U-1F Carlisle SecurEdge 2000 & 3000	120
U-1G Pressure-Sensitive PVC / KEE HP Cover Strip	121
Membrane Splices	
U-2A Membrane Splice	122
U-2B Thermoplastic Membrane Splices	123
Expansion Joints	
U-3A Deck-to-Deck Expansion Detail	124
U-3B Deck-to-Wall Expansion Detail	125
Curb Flashing	
U-5A Curb Flashing with TPO or PVC Membrane	126
U-5B Curb Flashing with TPO or PVC Coated Metal	127
U-5C Curb Flashing with CFA TPO or PVC Curb Wrap Corners	128
U-5D Self-Flashing Curb with CFA TPO or PVC Curb Wrap Corners	129
Drains	
U-6A Roof Drain (Drain Sump up to 3 inches to 1 Horizontal Foot).....	130
U-6B Roof Drain (Drain Sump Greater than 3 inches to 1 Horizontal Foot) Option 1	131

U-6C Roof Drain (Drain Sump Greater than 3 inches to 1 Horizontal Foot) Option 2 (Page 1 of 2)	132
U-6C.1 Roof Drain (Drain Sump Greater than 3 inches to 1 Horizontal Foot) Option 2 (Page 2 of 2)	133
U-6D Add-On Drain	134
Pipe Flashing	
U-8A Pre-Molded Pipe Flashing	135
U-8B Field Fabricated Pipe Flashing	136
U-8C CFA Certified Pre-Fabricated Square Tube Wrap	137
U-8D Field-Fabricated Square Tube Flashing	138
U-8D.1 Field Fabricated Hot Stack (25/30 Year Warranties)	139
U-8E CFA Certified Pre-Fabricated Split Pipe Seal	140
U-8F CFA Certified Hot Pipe Flashing	141
Terminations	
U-9 Membrane Terminations (Page 1 of 2)	142
U-9 Membrane Terminations (Page 2 of 2)	143
Parapet Flashing	
U-12A Parapet Flashing Fastened into Deck	144
U-12A.1 Parapet Flashing Fastened into Wall	145
U-12B Parapet Flashing with Pressure-Sensitive RUSS (Page 1 of 2)	146
U-12B.1 Parapet Flashing with Pressure-Sensitive RUSS (Page 2 of 2)	147
U-12C Coated Metal Wall Flashing	148
U-12F Parapet Flashing / No Adhesion – Any Height Option	149
U-12G TPO SAT Parapet Flashing with TPO RUSS	150
U-12H TPO SAT Parapet Flashing with TPO SAT RUSS	151
Tie-Ins	
U-13A TPO Tie-In to Built-Up Roofing Over Steel Roof Deck	152
U-13B TPO Tie-In to Built-Up Roofing Over Concrete Roof Deck	153
U-13C TPO/PVC Tie-In to Existing Single-Ply	154
U-13D TPO Tie-In to Existing EPDM Membrane	155
U-13E EPDM Tie-In on Concrete Deck	156
U-13F TPO/PVC Tie-In to Shingled or Metal Panel Roof	157
U-13G PVC/KEE HP Tie-In to Existing Single-Ply Membrane on Concrete Deck	158
U-13H PVC/KEE HP Tie-In to Existing Single-Ply Membrane on Metal Deck	159
Inside/Outside Corners	
U-15A Pre-Molded Inside Corner Flashing	160
U-15B Field Fabricated Inside Corner Flashing	161
U-15C Inside Corner with Coated Metal Flashing	162
U-15D Pre-Molded Outside Corner Flashing	163
U-15E Field Fabricated Outside Corner Flashing	164
U-15F Outside Corner with Coated Metal Wall Flashing	165
U-15G PVC or TPO Universal Corners- Combination Inside & Outside Corners	166
Sealant Pocket	
U-16A Molded Sealant Pocket	167
Through-Wall Scupper	
U-18A Scupper with Coated Metal	168
U-18B Scupper at Deck - TPO	169
U-18C Scupper with Sure-Flex Non-Reinforced PVC/ KEE HP Flashing	170
U-18D Scupper with Sure-Flex Non-Reinforced PVC/ KEE HP PS Cover Strip Flashing	171
Lightning Rods	
U-20A Lightning Rod at Parapet (Vertical Attachment)	172
U-20B Lightning Rod at Deck Level	173
Sleeper	
U-24 Sleeper Detail	174
Induction Welding Details	175
FP-1 Induction Welding Attachment Method – Fastening Patterns/Enhancements	177
FP-2 Induction Welding Attachment Method – Fastening Patterns/Enhancements	178
IW-1 IsoWeld® Attachment Method – Number of Fasteners and Location	179
IW-2 Angle Change Securement Method with IsoWeld Plates	180
IW-3 IsoWeld Wall Attachment	181
RB-1 RhinoBond® Attachment Method – Number of Fasteners and Location	182
RB-2 Angle Change Securement Method with RhinoBond Plates	183
RB-3 RhinoBond Wall Attachment	184

Liquid Flashing Details..... 185

Attachment 1- Inspection, Cleaning & Substrate Preparation (Page 1 of 2) 188
Attachment 1- Inspection, Cleaning & Substrate Preparation (Page 2 of 2) 189
Attachment 2- Application of LIQUISEAL® Primer & Resin 190
LF-1.1 Sheet Metal Drip Edge or Gravel Stop Flashing 191
LF-8.1 Single and Multiple Pipe Penetrations (Page 1 of 2)..... 192
LF-8.1 Single and Multiple Pipe Penetrations (Page 2 of 2)..... 193
LF-13.1 EPDM Membrane Tie-in with Existing Roof over Steel Deck 194
LF-13.2 TPO or PVC Membrane Tie-in with Existing Roof over Steel Deck (Page 1 of 2)..... 195
LF-13.2 TPO or PVC Membrane Tie-in with Existing Roof over Steel Deck (Page 2 of 2)..... 196
LF-13.3 Membrane Tie-in with Existing Roof over Concrete Deck..... 197
LF-18.1 Through-Wall Scupper 198
LF-30.1 Steel I-Beam Flashing (Page 1 of 2) 199
LF-30.1 Steel I-Beam Flashing (Page 2 of 2) 200

TPO Flashing Procedures Utilizing Sure-White® EPDM Flashing Products..... 201

MF-8BT Field-Fabricated Pipe Seal 203
U-1AT SecurSeal Drip Edge Fascia with Sure-White EPDM 204
U-5AT Curb / Wall with Sure-White EPDM & Sure-White SecurTape..... 205
U-5BT Curb with 20"-Wide Sure- White EPDM Pressure-Sensitive Cured Flashing 206
U-8AT Pipe: Pre-Molded Pressure-Sensitive Sure-White EPDM Pipe Seal 207
U-8DT Hot Stack: Field Fabricated Flashing with Sure-White PS Elastoform 208
U-12AT Parapet/Curb with Sure-White EPDM and Sure-White SecurTAPE 209
U-15CT Sure-White Pressure-Sensitive Inside Corner with Continuous TPO Wall Flashing 210
U-15ET Outside Corner with Pre-Cut Pressure-Sensitive Flashing (Option 1) 211
U-15GT Outside Corner with Pressure-Sensitive EPDM Flashing (Option 2) 212
U-16BT Pressure-Sensitive Pourable Sealer Pocket 213
U-18BT Scupper at Deck with Pressure Sensitive Elastoform 214

VacuSeal Details..... 215

V-0.1 Roof Assembly Over Existing Single-Ply Roof 215
V-0.2 Roof Assembly Over Existing Asphaltic Roof 216
V-0.3 Roof Assembly Over Steel Deck 217
V-0.4 Roof Assembly Over Poured-in-Place Concrete Deck 218
V-0.5 Roof Assembly Over Concrete Planks..... 219
V-0.6 Roof Assembly Over Lightweight Concrete Deck 220
V-0.7 Roof Assembly Over Wood Deck 221
V-1.1 Roof Edge: Roof Recover 222
V-1.2 Roof Edge: Tear-Off & Reroofing..... 223
V-5.1 Curb Base Flashing - New Construction and Re-Roof (Recover) 224
V-6.1 Roof Drain: Re-Roof (Recover) 225
V-6.2 Roof Drain: New Construction 226
V-8.0 VacuSeal™ Vent with Pre-Applied Skirt Flashing 227
V-8.1 Pipe/Structural Steel Tube Through Metal Deck..... 228
V-8.2 Multiple Penetrations Through Steel Deck - New Construction 229
V-8.3 Single Penetration Through Existing Roof Assembly 230
V-8.4 Cluster of Penetrations Through Existing Roof Assembly 231
V-8.5A Hot Stack Air Flashing - Option A 232
V-8.5B Hot Stack Air Flashing - Option B 233
V-12.1 Parapet with Membrane Air Barrier 234
V-12.2 Parapet/Curb: Concrete/Lightweight Concrete Used as an Air Barrier 235
V-12.3 Parapet or Wall - New Construction and Re-Roof (Recover)..... 236

Contact Information..... 237

SECTION 1: DESCRIPTION OF SYSTEMS

MECHANICALLY FASTENED THERMOPLASTIC ROOFING SYSTEMS (Sure-Weld / Spectro-Weld™ / Induction Weld / Sure-Flex PVC / Sure-Flex KEE HP)

The Sure-Weld Mechanically Fastened Roofing System

- White, Gray, and Tan Membrane Colors Available
- 4', 6', 8', 10', and 12' Widths Available
- 45-mil, 60-mil, and 80-mil Thicknesses Available
- Special Colors Available
- APEEL™ Protective Film Available

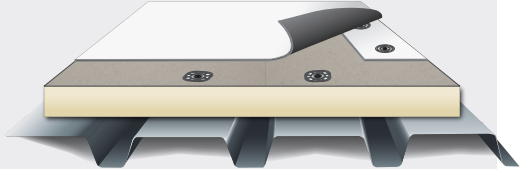

The Sure-Weld Spectro-Weld TPO Mechanically Fastened Roofing System

- White Membrane Only
- 6' and 10' Widths Available
- 60-mil and 80-mil Thicknesses Available

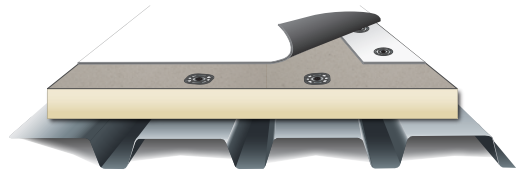

The Sure-Weld TPO Induction Welded Grid Mechanically Fastened Roofing System

- White, Gray, and Tan Membrane Colors Available
- 4', 6', 8', 10', 12', and 16' Widths Available
- 45-mil, 60-mil, and 80-mil Thicknesses Available
- Special Colors Available

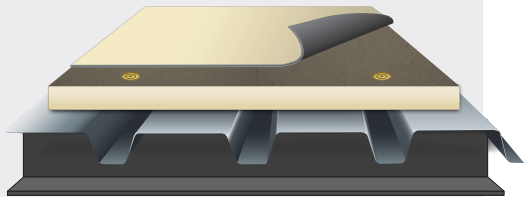

The Sure-Weld TPO Metal Retrofit Mechanically Fastened Roofing System

- White, Gray and Tan Membrane Colors Available
- 4', 6', 8', 10', and 12' Widths Available
- 60-mil and 80-mil Thicknesses Available
- Option 1 - PS Russ Strip
- Option 2 - Linear Induction Welded

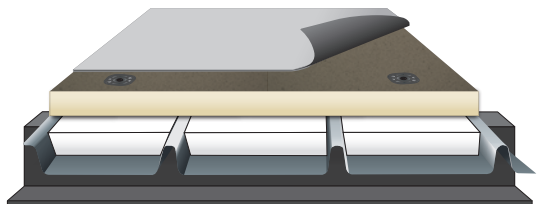

The Sure-Flex PVC Mechanically Fastened Roofing System

- White, Gray, Tan, Light Gray, and Slate Gray Colors Available
- 40.5", 5', 81", and 10' Widths Available
- 50-mil, 60-mil, and 80-mil Thicknesses Available
- APEEL Protective Film Available

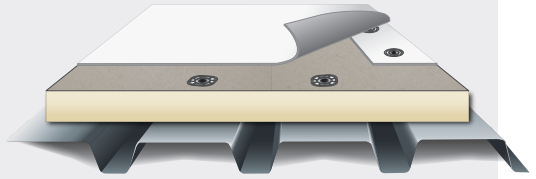

The Sure-Flex KEE HP Mechanically Fastened Roofing System

- White, Gray, Tan, and Light Gray Colors Available
- 5' and 10' Widths Available
- 50-mil, 60-mil, and 80-mil Thicknesses Available
- APEEL Protective Film Available

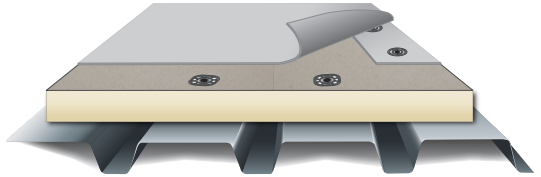

The Sure-Flex PVC and KEE HP Induction Welded Grid Mechanically Fastened Roofing System

- White, Gray, Tan, Light Gray, and Slate Gray (PVC Only) Colors Available
- PVC: 40.5", 5', 81", and 10' Widths Available
- KEE HP: 5' and 10' Widths Available
- 50-mil, 60-mil, and 80-mil Thicknesses Available

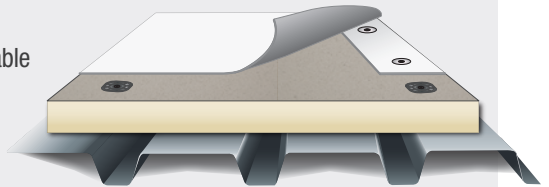

The Sure-Flex PVC and KEE HP Metal Retrofit Mechanically Fastened Roofing System

- White, Gray, Tan, Light Gray, and Slate Gray (PVC Only) Colors Available
- 40.5", 5', 81", and 10' Widths Available
- 60-mil and 80-mil Thicknesses Available
- Option 1 - Half Sheets
- Option 2 - Linear Induction Welded

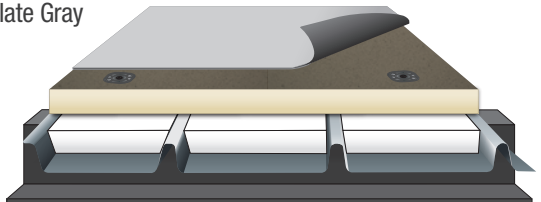

ADHERED THERMOPLASTIC ROOFING SYSTEMS

(Sure-Weld / Spectro-Weld / Sure-Weld SAT™ / Sure-Flex PVC / Sure-Flex KEE HP)

The Sure-Weld Adhered Roofing System

- White, Gray, and Tan Membrane Colors Available
- 4', 6', 8', 10', 12', and 16' Widths Available
- 45-mil, 60-mil, and 80-mil Thicknesses Available
- APEEL Protection Film
- Special Colors Available

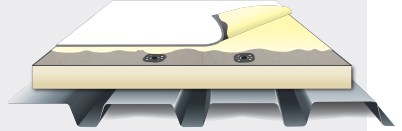

The Sure-Weld Spectro-Weld Adhered Roofing System

- White Membrane Only
- 10' Widths Available
- 60-mil and 80-mil Thicknesses Available

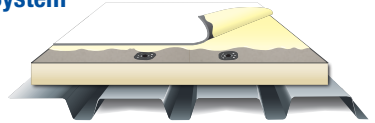

The Sure-Weld SAT (Self Adhering Technology) Roofing Systems

- White, Gray, and Tan Available
- 10' Widths Available
- 60-mil and 80-mil Thicknesses Available
- Laminated to an Elastomeric Pressure-Sensitive Adhesive

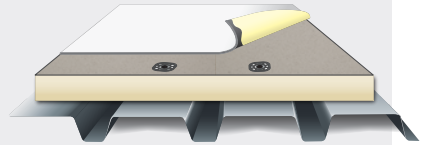

The Sure-Weld TPO VacuSeal Roofing System

- White, Gray, and Tan Membrane Colors Available
- 4', 6', 8', 10', and 12' Widths Available
- 45-mil, 60-mil, and 80-mil Thicknesses Available
- Special Colors Available
- APEEL Protective Film Available



The Sure-Flex PVC Adhered Roofing System

- White, Gray, Tan, Light Gray, and Slate Gray Colors Available
- 40.5', 5', 81", and 10' Widths Available
- 50-mil, 60-mil, and 80-mil Thicknesses Available
- APEEL Protective Film Available

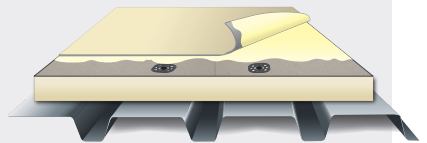

The Sure-Flex KEE HP Adhered Roofing System

- White, Gray, Tan, and Light Gray Colors Available
- 5" and 10' Widths Available
- 50-mil, 60-mil, and 80-mil Thicknesses Available
- APEEL Protective Film Available

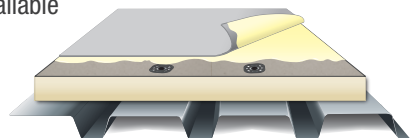

SECTION 2: PRODUCTS & ACCESSORIES

Insulation

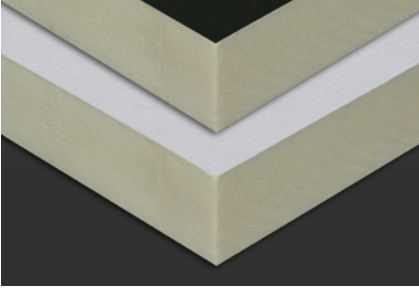

SecurShield with ReadyFlash Technology

A rigid roof insulation panel composed of a closed-cell polyisocyanurate foam core bonded to high performance **coated glass facers (CGF)**. ReadyFlash features a dark CGF to accelerate adhesive flash-off on one side of the insulation board and a light CGF to slow down adhesive flash-off on the other. Ideal for use in adhered membrane systems. Provides a direct to combustible deck UL Class A fire rating at 1" thickness.

Sizes: 4' x 4' and 4' x 8'

Thicknesses: ½" to 4 ½"

Compressive Strengths: 20 and 25 psi

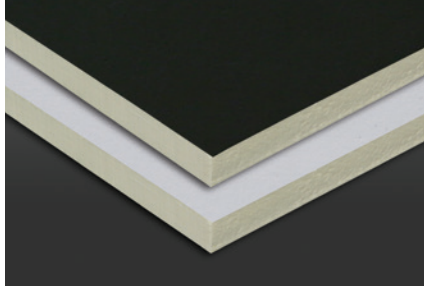

SecurShield HD with ReadyFlash Technology

A rigid roof insulation panel composed of ½" high-density, closed-cell polyisocyanurate foam core bonded to a premium performance **coated glass facer (CGF)** specifically designed for use as a cover board. ReadyFlash features a dark CGF to accelerate adhesive flash-off on one side of the insulation board and a light CGF to slow down adhesive flash-off on the other. Provides 5 times the R-value at one-fifth the weight of traditional gypsum cover boards. Achieves a UL Class A fire rating direct to combustible deck.

Sizes: 4' x 4' and 4' x 8'

Thickness: ½"

Compressive Strength: 109 psi max

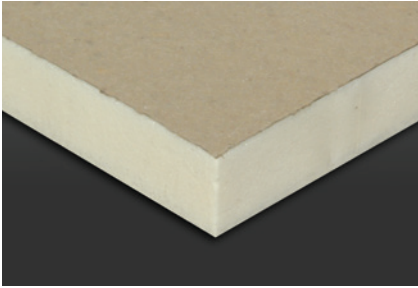

InsulBase Polyiso

A rigid roof insulation panel composed of a closed-cell polyisocyanurate foam core bonded to **glass-reinforced felt (GRF) facers**. UL and FM approved for direct application over steel decks, polyiso provides the highest R-value per inch of any commercially available insulation product.

Sizes: 4' x 4' and 4' x 8'

Thicknesses: ½" to 4 ½"

Compressive Strengths: 20 and 25 psi



StormBase Polyiso

A rigid roof insulation composite panel composed of a closed-cell polyisocyanurate foam core bonded to a glass-reinforced felt (GRF) facer on one side and ¾" **oriented strand board (OSB)** on the other.

Sizes: 4' x 4' (routed 3 sides) and 4' x 8' (routed 4 sides)

Thicknesses: 1 ½" to 4 ½"

Standard Thickness: 1 ½", 2", 2 ½", 3", and 4"

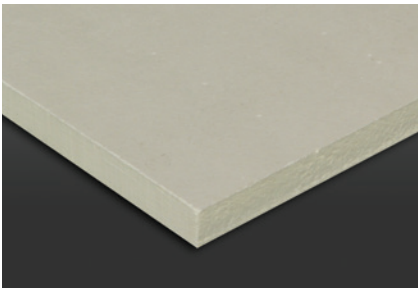

SecurShield HD Plus

A rigid roof insulation panel composed of a ½" high-density, closed-cell polyisocyanurate foam core bonded to a premium performance coated glass facer (CGF) specifically designed for use as a cover board. Enhanced performance of the HD Plus product provides a **FM 1-90 wind uplift rating with only 8 fasteners**.

Sizes: 4' x 4' and 4' x 8'

Thickness: ½"

Compressive Strength: 109 psi max

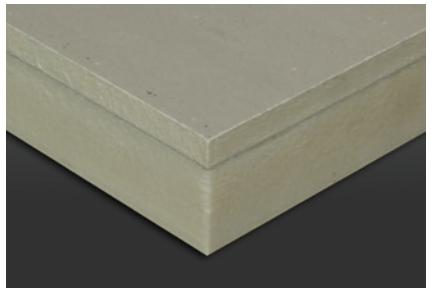

SecurShield HD Composite

A unique composite insulation panel comprised of ½" high-density polyiso cover board bonded during the manufacturing process to SecurShield rigid polyiso roofing insulation. Eliminates the need for a separate cover board, reduces inter-ply adhesives and saves labor on the roof. **A single product solution.**

Sizes: 4' x 4' and 4' x 8'

Thicknesses: 1 ½" to 4 ½"

Compressive Strengths: 20 psi (SecurShield) or 109 psi max (SecurShield HD)

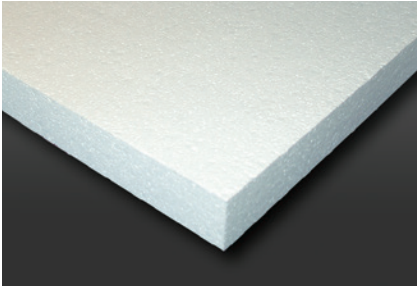

Carlisle EPS

Engineered rigid insulation made of high-performance, water-resistant expanded polystyrene (EPS). Meets ASTM C578 requirements, includes extensive UL and FM ratings, and can be applied direct to metal decks. Warranted long-term R-value of up to 4.76/inch @ 40°F.

Sizes: 4' x 4' or 4' x 8'; custom sizes and tapered panels available

Thicknesses: ¼" to 40" per panel

Densities: 1 to 3 lb/ft³

Compressive Strength: 10 to 60 lb/ft³

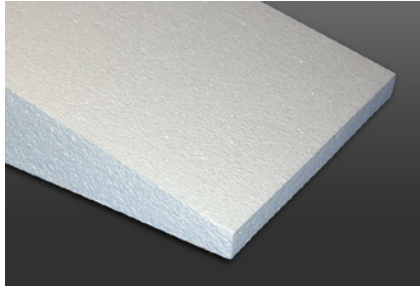

Carlisle Tapered EPS

Tapered engineered EPS insulation available in virtually any slope. Can be combined with Carlisle polyiso for tapered hybrid roof systems. Design assistance is available from Carlisle's Tapered Design Team. Custom saddles and crickets also available.

Slope: Virtually any slope

Thickness: ½" to 40"

Densities: 1 to 3 lb/ft³

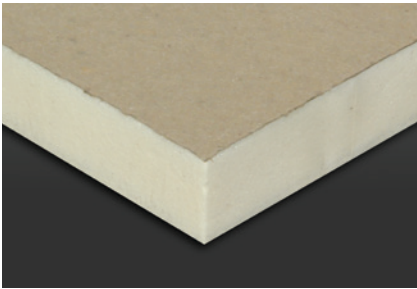

InsulBase NH

InsulBase NH Polyiso is an LBC "Red List Free" rigid roof insulation panel composed of a closed-cell polyisocyanurate foam core bonded on each side to fiber-reinforced paper facers. InsulBase NH contains **zero halogenated flame retardants**.

Sizes: 4' x 4' and 4' x 8'

Thickness: ½" to 4 ½"

Slope: 20 and 25 psi

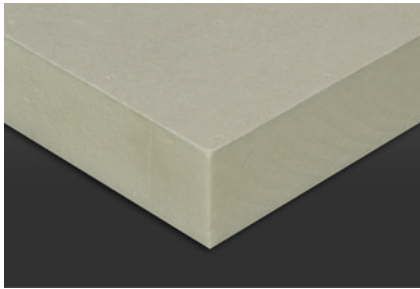

SecurShield NH

SecurShield NH Polyiso is an LBC "Red List Free" rigid roof insulation panel composed of a closed-cell polyisocyanurate foam core bonded during the manufacturing process to premium performance coated glass facers (CGF). SecurShield NH contains **zero halogenated flame retardants**.

Sizes: 4' x 4' and 4' x 8'

Thickness: ½" to 4 ½"

Slope: 20 and 25 psi

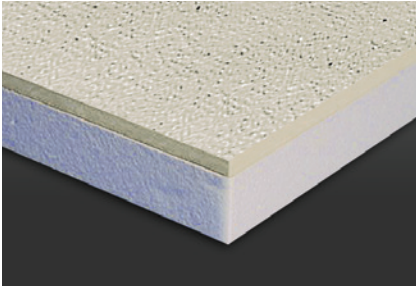

Carlisle HD EPS Composite

High-density polyiso cover board (1/2") laminated to Carlisle's engineered EPS. Five times lighter than traditional cover boards. Approved for both adhered and mechanically attached systems. Provides enhanced protection against severe weather and hail and meets Title 24 requirements for continuous insulation on combustible decks.

Sizes: 4' x 4' or 4' x 8'; custom sizes and tapered panels available

Thickness: 1 1/2" to 7" (including 1/2" HD polyiso cover board)

Densities: 1 to 3 lb/ft³

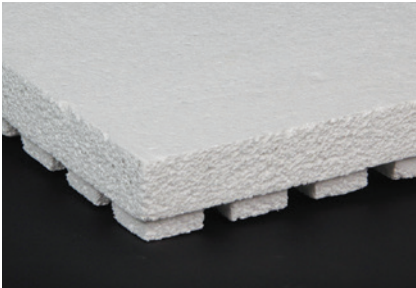

ChannelDry®

Carlisle's high-performance ChannelDry insulation is composed of lightweight, closed-cell expanded polystyrene meeting the requirements of ASTM C578 Type IX. ChannelDry has excellent dimensional stability, compressive strength, and water-resistant properties. ChannelDry is designed to be mechanically fastened directly to concrete decks. The use of ChannelDry in conjunction with one-way and two-way relief vents allows the installation of the roof system to begin upon structural cure of concrete.

Sizes: 4' x 4'

Thickness: 2"

Compression Strength: 25 psi

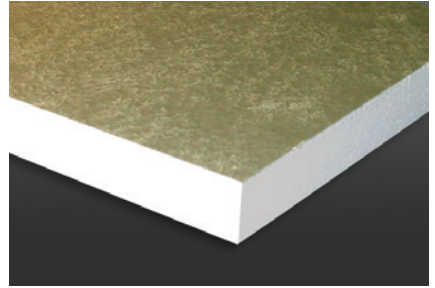

Carlisle SP EPS

Premium coated-glass-faced insulation approved for mechanically attached or self-adhering systems without a slip sheet. Warranted long-term R-value provides up to R-30 in a single layer.

Sizes: 4' x 4' or 4' x 8'; custom sizes and tapered panels available

Thicknesses: 1/4" to 6"

Densities: 1 1/4 to 3 lb/ft³

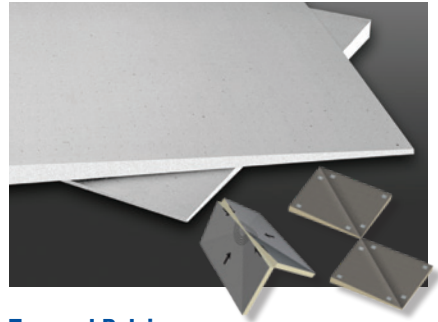

Tapered Polyiso

A sloped, rigid roof insulation panel composed of a closed-cell polyisocyanurate foam core bonded to a coated glass or fiber-reinforced facer. Designed to promote **positive drainage** and **prevent ponding water**.

Hinged Target Sumps and Pre-Cut Hips and Valleys ship ready to install, **require no field cuts and save valuable time on the roof**. Multiple thicknesses and slopes available to accommodate specific job conditions with no waste, thus reducing disposal fees.

Sizes: 4' x 4' and 4' x 8' 4' x 4' (Sump)

4' x 4' (Hip/Valley) 8' x 8' (Sump)

Thicknesses: 1/2" to 4 1/2" (multiple layers utilized for increased thicknesses)

Compressive Strengths: 20 and 25 psi

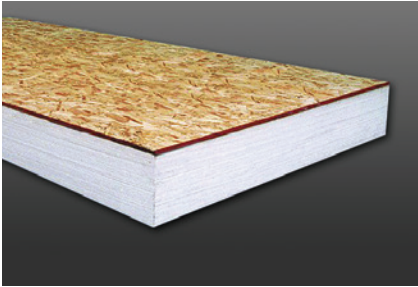

Carlisle InsulLam™

OSB, plywood, or gypsum board laminated to Carlisle's engineered EPS. Approved for both adhered and mechanically attached systems. Provides enhanced protection against severe weather and hail. Can be utilized as a nail base, is available vented and with a wide assortment of cover boards.

Sizes: 4' x 4' or 4' x 8'

Thickness: 1½" to 7"

Laminate: OSB 7/16" and 5/8"; plywood 5/8"; gyp. thickness varies

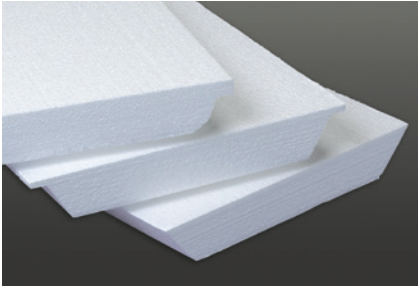

Carlisle EPS Flute-fill

Custom-cut, engineered EPS flute-fill insulation manufactured for virtually any standing seam profile. Meets ASTM C578 requirements and includes extensive UL and FM ratings, including direct to metal deck installations.

Thickness, Shape and Size: Custom manufactured to fit any roof profile

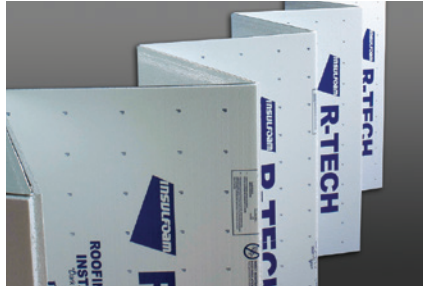

R-Tech Fanfold Recover Board

High-performance water-resistant facers laminated to Carlisle engineered EPS. Code-approved for recover applications and compatible with both light- and dark-colored single-ply membranes. Five times lighter than traditional cover boards with a coverage rate of 200 sq. ft. Saves time and labor on the roof.

Sizes: 2' x 4' (folded), 4' x 50' (unfolded)

Thicknesses: ¼", ⅜", ½", ¾"

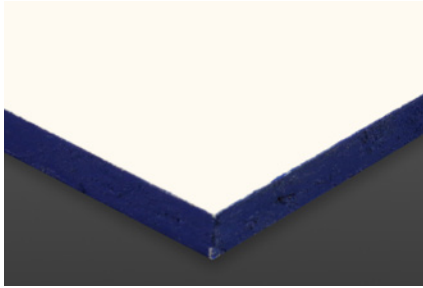

EcoStorm VSH™

Engineered composite building material made from a proprietary blend of plastic and cellulose fiber sourced from post-industrial and post-consumer waste streams.

Sizes: 4' x 4' and 4' x 8'

Thickness: ½"

Compressive Strength: 3990 psi

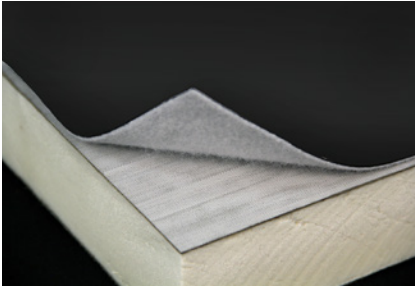

InsulBase RL and SecurShield RL

InsulBase RL is a standard density polyisocyanurate roof boards specially designed to act as the hook in the RapidLock (hook and loop) system. InsulBase RL utilizes a GRF facer and SecurShield RL a CGF facer.

Size: 4' x 8'

Thickness: 2.0" and 2.6"

Compressive Strengths: 20 psi

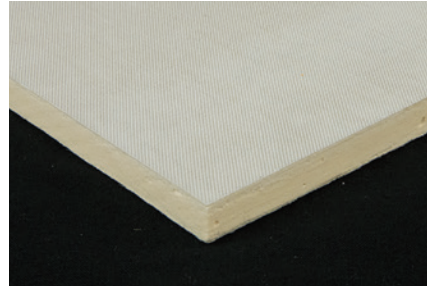

SecurShield HD RL

SecurShield HD RL is a high-density rigid roof polyisocyanurate board bonded to coated-glass (CGF) facers specially designed to act as the hook in the RapidLock (hook and loop) system.

Sizes: 4' x 8'

Thickness: ½"

Compressive Strength: 109 psi max



SecurShield HD Composite RL

SecurShield HD Composite RL is a rigid roof insulation panel composed of a top layer of high-density, closed-cell foam, and a bottom layer of 20 psi closed-cell foam, specifically designed to act as the hook in the RapidLock system. This creates a single-component solution that eliminates the need for a coverboard.

Sizes: 4' x 8' and 4' x 4'

Thickness: 2.0" to 4.0"

Compressive Strength: 20 psi (SecurShield) and 109 psi max (SecurShield HD)

Fasteners & Plates

Insulfast™ Fastener



Can be used to secure insulation. Compatible with wood (minimum $1\frac{5}{32}$ " [12mm] CDX plywood) and steel decks (22-gauge [0.76 mm] or heavier).

Sizes Available:

$1\frac{5}{8}$ ", 2", 2 $\frac{1}{4}$ ", 3"-8" (1" increments)

Size & Quantity Per Box:

$1\frac{5}{8}$ ", 2 $\frac{1}{4}$ ", 2"-8": 1,000

ASAP Insulfast Fastener & Plate



A pre-assembled InsulFast fastener and plastic or metal insulation plate is acceptable for insulation attachment in both mechanically attached and fully adhered applications.

Can be used to secure insulation. Compatible with wood (minimum $1\frac{5}{32}$ " [12mm] CDX plywood) and steel decks (22-gauge [0.76 mm] or heavier). Longer fastener sizes available through special order.

Sizes Available:

2 $\frac{1}{4}$ ", 3" – 8" (1" Increments)

Size & Quantity Per Box:

2 $\frac{1}{4}$ " – 8": 250; 10" – 12": 200

Applications requiring a fastener larger than 8" should use HD 14-10 fasteners.

HP-X Fastener™ & HP-XTRA Fastener



Can be used to secure membranes, RUSS, and insulation. Compatible with wood (minimum $1\frac{5}{32}$ " [12mm] CDX plywood) and steel decks (22-gauge [0.76 mm] or heavier).

Sizes Available:

2" – 8" (1" Increments)
10" – 16" (2" Increments)

Size & Quantity Per Box:

2" – 4": 1,000; 5" – 12": 500;
14" – 16": 250

HP-XTRA Fastener

Also available (not shown)

A #21 diameter fastener compatible with wood (minimum $1\frac{5}{32}$ " [12mm] CDX plywood) and steel decks (22-gauge [0.76 mm] or heavier).

Sizes Available:

2" – 8" (1" increments)

Size & Quantity Per Box:

500 (2" – 6"), 250 (7" – 8")

HD 14-10 Fastener



Can be used to secure membranes, RUSS, and insulation. Compatible with wood (minimum $1\frac{5}{32}$ " [12mm] CDX plywood) and structural concrete (minimum 2,500 psi).

Sizes Available:

2" – 12" (1" Increments)
14" – 24" (2" Increments)

Size & Quantity Per Box:

2" – 4": 1,000; 5" – 11": 500;
12" – 24": 250

 Sure-Weld TPO
 Sure-Flex PVC

GypTec Fastener & Plate



Can be used to secure membranes, RUSS, and insulation. Applicable to cementitious wood fiber, lightweight concrete and gypsum decks.

Sizes Available:
2½"– 10" (½" Increments)

Size & Quantity Per Box:
2½"– 7": 500; 7½"– 10": 250

GypTec Plate



Sizes Available:
2" Metal membrane plate
3" Metal insulation plate

Quantity Per Box: 1,000

HP-X ASAP



A pre-assembled HP-X fastener and Piranha Plate™. Can be used to secure membranes, RUSS, and insulation. Compatible with wood (minimum 1½" [12mm] CDX plywood) and steel decks (22-gauge [0.76 mm] or heavier).

Sizes Available:
2"–10" (1" Increments)
12"–16" (2" Increments)

Size & Quantity Per Box:
2"– 9": 250; 10"– 12": 200;
14"– 16": 150

CD-10 Fastener



Can be used to secure membranes, RUSS, and insulation. Compatible with structural concrete decks (minimum 2,500 psi).

Sizes Available:
2"– 6" (½" Increments)
7"– 12" (1" Increments)

Size & Quantity Per Box:
2"– 8": 500; 9"– 12": 250

HP Lite-Deck Fastener



Used in conjunction with a specially designed 3" Lite-Deck Metal Plate for Insulation attachment to gypsum, cementitious wood fiber (Tectum). Features an oversize diameter (0.312" shank) and a deep, coarse thread designed for high pullout resistance.

Sizes Available:
2⅝", 3"– 10", 12" (1" Increments)

Size & Quantity Per Box:
2⅝"– 4": 500; 5"– 8": 250;
9", 10", 12": 125

■ Sure-Weld TPO
■ Sure-Flex PVC

Purlin Fastener ■ ■



Used with Carlisle's Metal Retrofit Roofing System to secure membrane and RUSS to structural steel purlins. Provides superior back-out resistance in standard 16-gauge Purlins.

Sizes Available:
3¾", 4¾", 5¾", 7", 8"

Quantity Per Box: 1,000

RetroDriller Fastener ■ ■



A specially designed fastener with a ½" drill point used for attaching Sure-Weld and Sure-Flex membranes to structural steel purlins (up to ¾") in standing seam metal roof retrofit applications.

Sizes Available:
4", 5", 6", 8", & 10"

Size & Quantity Per Box: 500

Lite-Deck Metal Plate ■ ■



Used in conjunction with HP Lite-Deck Fasteners for insulation attachment to gypsum, cementitious wood fiber (Tectum).

Sizes Available:
3" diameter

Quantity Per Box: 500

Induction Welding Plate ■ ■



A 3" round specially coated plate is used with HP-X Fasteners and the corresponding induction welding tool for membrane and insulation attachment.

Sizes Available:
3" diameter

Quantity Per Box: 500

Options Include:
RhinoBond Induction Welding Plate
isoweld Induction Welding Plate

AccuTrac Plate (Insulation) ■ ■



AccuTrac Plates are 3" square flat- or recessed-bottom plates made of Galvalume-coated steel. Used to fasten insulation with the AccuTrac Tool.

Sizes Available: 3"

Quantity Per Box: 1,000

Insulation Fastening Plate ■ ■



Used for insulation securement over wood (minimum 1½" [12mm] CDX plywood), steel (22-gauge [0.76 mm] or heavier), and concrete decks. Available in steel and plastic versions.

Sizes Available:
3" diameter

Quantity Per Box: 1,000

■ Sure-Weld TPO
■ Sure-Flex PVC

Piranha Plate ■ ■



Used to secure Sure-Weld and Sure-Flex membranes over wood (minimum $1\frac{5}{32}$ " [12mm] CDX plywood), steel (22-gauge [0.76 mm] or heavier), and concrete decks.

Sizes Available: $2\frac{3}{8}$ " diameter

Quantity Per Box: 1,000

HP-Xtra Piranha Plate

Also Available (not shown)

Used with HP-XTRA Fasteners to secure Sure-Weld and Sure-Flex membranes to wood (minimum $1\frac{5}{32}$ " [12mm] CDX plywood), steel (22-gauge [0.76 mm] or heavier) decks.

Sizes Available:

$2\frac{3}{8}$ " diameter

Quantity Per Box: 1,000

SecurFast™ Insulation Fastening Plate ■ ■



Designed for SECUROCK securement under Sure-Flex or Sure-Weld roofing systems. Plates are stamped from Galvalume-coated steel for long-term protection against corrosion.

Sizes Available: $2\frac{7}{8}$ "

Quantity Per Box: 1,000

Termination Bar (Aluminum) ■ ■



Extruded aluminum bar that is designed for securing and sealing compression type flashing terminations. The bar features a top edge for ease of applying Carlisle's Lap Sealant or Universal Single Ply Sealant for TPO installations. The bar can be easily cut to any desired length.

Sizes Available:

1" wide x 10' long

Quantity Per Box: 50 pcs; 500

Linear Feet

Term Bar Nail-In ■ ■



Used with Carlisle's Termination Bar or Seam Fastening Plates to secure membrane to concrete block, brick, or structural concrete walls. A zinc-plated steel pin provides excellent corrosion resistance while the zinc alloy body provides excellent holding power.

Sizes Available: $1\frac{1}{4}$ "

Quantity Per Box: 1,000

■ Sure-Weld TPO
■ Sure-Flex PVC

Oval Barbed Plate ■



Along with the appropriate fastener, used to secure Sure-Flex membranes to wood (minimum 1½" [12mm] CDX plywood) and steel decks (22-gauge [0.76 mm] or heavier).

Sizes Available:

1½" x 2¾" Oval

Quantity Per Box: 500

Dual Prong Fasteners



Designed to secure base sheets over gypsum, fibrous cement, and lightweight concrete decks and consist of a galvanized (G-90) tube, a 2.7"-diameter GALVALUME® plate, and a locking staple formed from high-tensile coated

steel wire. Dual Prong Fasteners are installed using Carlisle's stand-up Dual Prong Applicator, which holds and drives the tube into the deck and sets the wires.

Sizes Available: 1.8" (45.17 mm)

Quantity Per Box: 500

Adhesives, Primers, & Sealants

Sure-Weld TPO Bonding Adhesive ■



A high-strength, solvent-based contact adhesive that allows bonding of Sure-Weld membrane to various porous and non-porous substrates.

Coverage Rate: 60 square feet per gallon of finished surface.

Packaging: 5-gallon pail

Product Number: 302099

Shelf Life: 12 months

Aqua Base 120 Bonding Adhesive ■



A semi-pressure-sensitive, water-based adhesive. This product may be used as a two-sided contact adhesive with standard TPO and FleeceBACK® TPO membranes.

Coverage Rate: 120 square feet per gallon of finished surface. (May vary due to conditions such as insulation type or wall construction.)

Packaging: 5-gallon pail

Product Number: 307431

Shelf Life: 12 months

- Sure-Weld TPO
- Sure-Flex PVC

Low-VOC Bonding Adhesive* ■



A high-strength, solvent-based contact adhesive that allows bonding of all TPO membranes to various porous and non-porous substrates. This product meets the <250 gpl VOC content requirements of the OTC Model Rule for Single-Ply Roofing Adhesives.

Coverage Rate: 60 square feet per gallon of finished surface.

Packaging: 5-gallon pail

Product Number: 303090

Shelf Life: 12 months

HydroBond™ PVC Water-Based Adhesive ■



A water-based, wet lay-in, one-sided dispersion adhesive used to adhere all Sure-Flex PVC and FleeceBACK membranes to a variety of substrates. Complies with the California Clean Air Act of 1988 (updated in 1997) and California Air Quality Control District's listing of VOC limitations.

Meets the requirements of the OTC Model Rule for Single-Ply Roofing Adhesives. *Cannot be used with KEE HP smooth-backed membrane.*

Coverage Rate:

Smooth-backed membrane:

Roller application – 100 square feet per gallon of finished surface.

Spray application – 133 square feet per gallon of finished surface.

FleeceBACK membrane:

Roller application – 100 square feet per gallon over polyiso, DensDeck, DensDeck Prime, SECUROCK, and plywood.

Spray application – 100 square feet per gallon over DensDeck and 133 square feet per gallon over polyiso, DensDeck Prime/SECUROCK, and plywood.

Packaging: 5-gallon pail

Product Number: 322112

Shelf Life: 12 months

Weathered Membrane Cleaner ■



Used to clean both new and in-service TPO membranes prior to seaming or application of Pressure-Sensitive (PS) products. Helps to loosen and remove

dirt and other contaminants from the surface of the membranes and leaves a suitable surface for application of adhesive or primer. Please refer to the Product Data Sheets for specific instructions for TPO applications.

Coverage Rate: 400 square feet (one surface) per gallon.

Packaging:

(2) 1-gallon closed-top cans,
5-gallon closed-top pail
1-gallon cans

Product Number: 304066 5-gallon pail

Product Number: 302074

Low-VOC Bonding Adhesive 1168* ■



A high-strength, solvent-based contact adhesive that allows bonding of all Sure-Weld TPO membranes to various porous and non-porous substrates. This product meets the requirements for SCAQMD regulations.

Coverage Rate: 60 square feet per gallon of finished surface.

Packaging: 5-gallon pail

Product Number: 318847

Shelf Life: 12 months

* Not compliant in all CA counties

■ Sure-Weld TPO
■ Sure-Flex PVC

Flexible FAST™ Adhesive



A low-rise, two-component, VOC-free, energy-absorbing, impact-resistant adhesive used to adhere FleeceBACK membranes and insulation boards to various substrates for a totally non-penetrating system application. Flexible FAST adhesive provides a wider window of temperature workability (25°F - 120°F).

Coverage Rate: See Product Data Sheet.

Packaging:

50-gallon drums – Part A – Product Number: 310472
50-gallon drums – Part B – Product Number: 310473
15-gallon drums – Part A – Product Number: 317329
15-gallon drums – Part B – Product Number: 317331
5-Gallon Jug – Part A – Product Number: 329722
5-Gallon Jug – Part B – Product Number: 329723
Dual Tank – Part A – Product Number: 336119
Dual Tank – Part B – Product Number: 336341
Dual Cartridge – Product Number: 322958

Shelf Life: 12 months (Part A and Part B)

Flexible FAST Accessories:

5-Gallon Jug – Static Mixing Tip (Patriot Jr., HULK, PaceCart): 331294
DUAL TANK Nozzle Extension Tubes 14": 330881
DUAL TANK Nozzle Tips: 341412
DUAL TANK Gun Hoses 25': 341411

Low-VOC UN-TACK™ Adhesive Remover and Cleaner



Used to clean spray guns and hoses applied by CAV-GRIP® III Low-VOC Adhesive/Primer. Removes adhesives and primers from a variety of surfaces including single-ply membranes, accessories, metal, plastic, rubber, and glass. Low-VOC UN-TACK is VOC compliant in all 50 states.

Coverage Rate: 250 – 300 square feet per cylinder

Packaging: #8 Aerosol Cylinder

Product Number: 330793

PVC and KEE HP Membrane Cleaner



This cleaner is specially formulated to clean both new and in-service Sure-Flex PVC and KEE HP membranes.

Coverage Rate: 400 square feet (one surface) per gallon.

Packaging: 5-gallon closed-top pail

Product Number: 329729

■ Sure-Weld TPO

■ Sure-Flex PVC

Low-VOC PVC Bonding Adhesive



A high-strength, solvent-based contact adhesive that allows bonding of PVC and KEE HP membranes to various porous and non-porous substrates. Meets the <250 gpl VOC content requirements of the OTC Model Rule for Single-Ply roofing adhesives.

Coverage Rate: 60 square feet per gallon of finished surface.

Packaging: 5-gallon pail

Product Number: 309126

Shelf Life: 12 months

Low-VOC Primer



Designed for one-step cleaning and priming of TPO surfaces prior to the application of pressure-sensitive products. It is a Low-VOC product that is ideal for use where environmental issues are a concern.

Coverage Rate: As high as 700 square feet per gallon with TPO or Kleen EPDM membrane. Approx. 250 square feet per gallon with dusted EPDM membrane.

Packaging:

3-gallon pail – Product Number: 332714

5-gallon pail – Product Number: 329160

Shelf Life: 12 months

CAV-GRIP III Low-VOC Adhesive/Primer



Carlisle's CAV-GRIP III Low-VOC Adhesive/Primer can be used for a variety of applications: adhering Sure-Weld TPO and Sure-Seal®, Sure-Tough™ and Sure-White EPDM membranes in the field of the roof and vertical walls, and adhering FleeceBACK to vertical walls. It can also be used as a primer for VapAir Seal™ 725TR and priming unexposed asphalt prior to applying Flexible FAST Adhesive for insulation attachment.

Coverage Rate: See Product Data Sheet.

Packaging:

40 aerosol cylinder – Product Number: 329902

85 aerosol cylinder – Product Number: 332659

Adjustable Spray Gun – Product Number: 307490

Spray Gun with Extension – Product Number: 330912

Replacement Tips – Product Number: 332774

6' Hose – Product Number: 304302

12' Hose – Product Number: 304303

18' Hose – Product Number: 304304

Hose Splitter – Product Number: 332680

Shelf Life: 12 months unopened container

Spray Patterns:

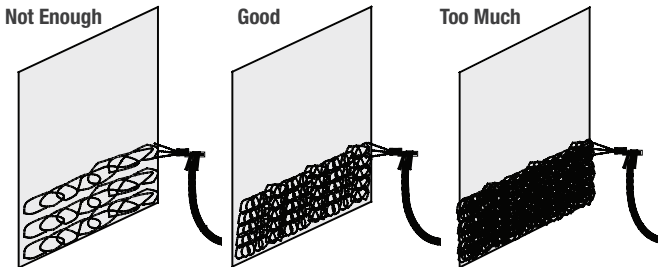

■ Sure-Weld TPO

■ Sure-Flex PVC



CAV-GRIP PVC Adhesive

Overview

CAV-GRIP PVC Aerosol Contact Adhesive can be used for a variety of applications: adhering PVC bareback membranes to a variety of horizontal substrates and vertical walls (cannot be used with any KEE or KEE HP bareback membranes), adhering FleeceBACK membranes to vertical walls.

Coverage Rate: See Product Data Sheet

Packaging:

Standard Cylinder - 335178

Large Cylinder - 336104

Shelf Life: 12 months unopened container

Installation

1. Connect spray gun to hose and connect hose to cylinder. Open valve on cylinder to check fittings for leaks. Keep cylinder valve open to maintain pressure in the hose/spray gun when not in use.
2. CAV-GRIP PVC can be applied at ambient temperatures of 35°F (1°C) and above. Propellant in cylinders must be kept above 70°F (21°C) for the product to spray properly. Utilize power-heated blankets and hot boxes when necessary. Ensure that cylinder temperatures stay below 110°F (43°C). Substrate shall be clean, dry, and free of debris and contaminants.
3. For applications taking place in ambient temperatures below 70°F (21°C), store cylinders in heated space and move to project area during application. Cylinders must be kept warm on the jobsite. Dispense product from cylinder while it is still warm. When product in cylinder becomes too cold, it will begin to spit rather than spray. If this occurs, swap cold cylinder for warmer one and return cold cylinder to heated area. When changing

cylinder, close the valve on the cylinder and depressurize the hose. Remove the hose and attach to the new cylinder. Open valve and do a test spray.

4. Apply CAV-GRIP PVC in an even coat to substrate (refer to the drawing on the next page), keeping the spray tip approximately 12" (30.5 cm) away and perpendicular to the surface during spray. Avoid high thickness buildup.
5. Allow CAV-GRIP PVC to flash-off (roughly 5-7 minutes depending upon ambient temperature). Once flashed-off, adhesive will have little to no tackiness and provides an application window of roughly 15-20 minutes depending upon ambient temperature. Limit application of CAV-GRIP PVC to surfaces that will be covered with membrane.

Vertical Applications of Standard PVC or Any FleeceBACK Membrane

Acceptable substrates include: Carlisle's InsulBase Polyiso, SecurShield Polyiso, SecurShield HD, SecurShield HD Plus, DensDeck Prime, SECUROCK, OSB, plywood, metal, and clean concrete block.

Residual asphalt is an acceptable substrate for FleeceBACK membranes only. To improve adhesion and reduce the potential for asphalt bleedthrough on vertical surfaces with residual asphalt, apply an initial "sealing" base coat of CAV-GRIP PVC and allow to flash off properly; then, apply a secondary coating of CAV-GRIP PVC to the vertical surface. Contact Carlisle before using on substrates other than those listed above. There are no height restrictions when using CAV-GRIP PVC for vertical applications if the appropriate membrane terminations are utilized.

1. Spray wall and back of the membrane, utilizing a 50% overlapping spray pattern.
2. Do not apply adhesive to splice areas to be hot-air welded.
3. Allow adhesive to become tacky but not overly dry; it should not transfer to fingers when touched.
4. Mate membrane with the wall from the center of the sheet toward the edges, smoothing by hand.
5. Broom the membrane with a soft-bristle broom.
6. Roll in with a hand roller.

Horizontal Application of Bareback PVC Membranes

Acceptable substrates include: Carlisle's InsulBase Polyiso, SecurShield Polyiso, SecurShield HD, SecurShield HD Plus, DensDeck Prime, SECUROCK, OSB, and plywood. Please see Carlisle's Specifications for a complete list of acceptable substrates.

The surface on or against which adhesive is to be applied shall be clean, smooth, dry, free of films, sharp edges, loose and foreign materials, oil, and grease. Depressions greater than ¼" (6 mm) should be feathered using epoxy, mortar, or other approved patching material. All sharp projections shall be removed by sweeping, blowing, or vacuum cleaning. Application shall be continuous and uniform, avoiding globs or puddles.

1. Spray substrate and back of the membrane with enough overlap to ensure 100% coverage (2-3" of overlap).
2. Do not apply adhesive to splice areas to be hot-air welded.
3. Allow adhesive to become tacky but not overly dry; it should not transfer to fingers when touched.
4. Roll the membrane onto the adhesive-coated substrate while avoiding wrinkles. Immediately brush down the bonded portion of the sheet with a soft-bristle push broom, and then roll the membrane with a 150-lb weighted segmented roller to achieve maximum contact.

CLEANUP: Carlisle's CAV-GRIP PVC UN-TACK safe solvent or mineral spirits can be used to clean tools and surfaces. If the spray gun valve becomes stuck, attach hose and spray gun to cylinder of PVC UN-TACK and trigger spray gun repeatedly until operation is smooth. If the spray gun is clogged, soaking the brass fitting in PVC UN-TACK is helpful. For application procedures and precautions please see the low-VOC UN-TACK Adhesive Remover and Cleaner Product Data Sheet.

Spray Patterns:

Not Enough

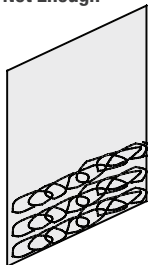

Good

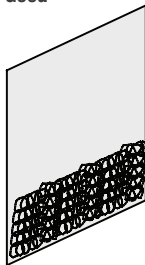

Too Much

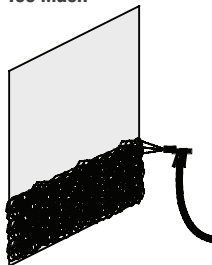

CAV-GRIP PVC UN-TACK Low-VOC Adhesive Remover and Cleaner

Overview

Carlisle's CAV-GRIP PVC UN-TACK Adhesive Remover and Cleaner is designed to remove adhesives and primers from a variety of surfaces including single-ply membranes, accessories, metal, plastic, rubber, and glass. PVC UN-TACK can also be used to clean spray guns and hoses used to apply CAV-GRIP PVC Low-VOC Adhesive. DO NOT use CAV-GRIP PVC UN-TACK for removal of CAV-GRIP III Adhesive/Primer.

Coverage Rate: 250 – 300 ft²/Cylinder surface area to be cleaned

Packaging: #8 Aerosol cylinder

Product Number: 336090

CAV-GRIP III Accessories

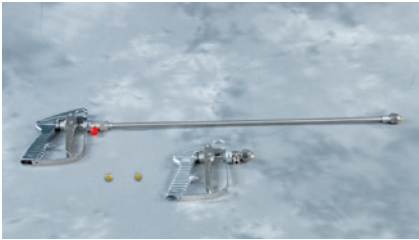

Spray Gun

Carlisle's CAV-GRIP Spray Gun is an industrial grade spray gun for use with CAV-GRIP III Low-VOC Adhesive/Primer. The ergonomic handle makes it easy to apply bonding adhesive to vertical surfaces.

Installation

1. Use the adjustment wheel to close the valve until ready to use
2. Ensure all fittings are tight and leak free
3. Position the gun tip 12" to 14" from the surface. This allows for maximum pattern width.
4. Hold gun at a 90 degree angle to the surface by locking your wrist. Try not to move your wrist as that will cause an irregular spray pattern.
5. When you are done spraying, turn the adjustment wheel to the closed position. This will lock the gun.
6. When you want to resume spraying, turn the adjustment wheel to the open position. No cleaning should be needed if the hose and gun remain pressurized.
7. To clean the CAV-GRIP spray gun, turn the cylinder off at the valve. Ensure there is no adhesive left in the hose and gun. Hook the hose up to a cylinder of Low-VOC UN-TACK to clean the system. Turn cylinder off and drain Low-VOC UN-TACK from the hose.
8. Use an adjustable wrench to remove and replace spray tips as necessary.



Hose & Splitter

CAV-GRIP Low-VOC Adhesive/Primer Hose should be used in conjunction with CAV-GRIP III and a CAV-GRIP Spray Gun. The CAV-GRIP Hose is available in 6', 12' and 18' lengths.

Installation

1. Ensure all fittings are tight and leak free
2. No cleaning should be needed if the hose and gun remain pressurized.
3. To clean the CAV-GRIP spray gun, turn the cylinder off at the valve. Ensure there is no adhesive left in the hose and gun. Hook the hose up to a cylinder of Low-VOC UN-TACK to clean the system. Turn cylinder off and drain Low-VOC UN-TACK from the hose.
4. Use an adjustable wrench to attach the splitter to the CAV-GRIP cylinder.
5. Attach hoses to both ends of the splitter using an adjustable wrench.

Dual-Tip Spray Applicator



Carlisle's Dual-Tip Spray Applicator, specially designed for use with CAV-GRIP III, reduces application time by spraying two streams of adhesive with a single CAV-GRIP Spray Gun and Hose.

Product Number: 348903

CAV-PRIME Products & Accessories



CAV-PRIME Sure-Weld TPO Primer

Overview

CAV-PRIME Sure-Weld TPO Primer is Carlisle's TPO Primer packaged in a pressurized cylinder for spray application. Sure-Weld TPO Primer is used to prepare TPO membrane for improved adhesion to pressure-sensitive TPO accessories. CAV-PRIME primers are applied using a self-contained spray system coupled with a spray gun with extension wand and applicator attachment kit. CAV-PRIME spray guns, hoses, and applicator attachment kits are each sold separately.

Coverage Rate: Approximately 1,540 ft² /cylinder can be expected

Packaging: #20 cylinder

Product Number: 341448



CAV-PRIME Accessories, Assembly, Application, Storage and Cleaning

Overview

Application of membrane primer from a pressurized cylinder will require the following accessories:

CAV-PRIME Cylinder

Spray Gun with 24" (330912) or 36" Extension (341897)
6'-long Material Hose (304302)

CAV-PRIME Backpack (341898)

Applicator Kit (341228)
4"-wide Paint Roller Frame with 3/8" -nap Cover
Low-VOC Gun and Hose Cleaner (341407)



Assembly

1. Cut out the perforation at the top of the CAV-PRIME cardboard carton. Push the material hose through the perforation and thread onto the cylinder. Tighten the fitting with a 9/16" open end wrench or an adjustable wrench.
2. Thread the other end of the material hose to the spray gun. Tighten the fitting with a 3/4" wrench or an adjustable wrench. Make sure the trigger is in the locked position.
3. Install the CAV-PRIME Applicator Kit attachment and roller on the spray gun with extension nozzle. Follow the instructions provided in the applicator attachment kit (341228).

- Place the CAV-PRIME cylinder in the backpack. Secure the cylinder in the backpack with the adjustable strap.
- Open the valve on the top of the cylinder to the fully open position. As the hose becomes pressurized, make sure there are no leaks.
- Shoulder the backpack and adjust the straps for a snug fit.

CAV-PRIME Low-VOC Cleaner must be used to flush and clean the gun and hose prior to storage. Do not interchange cleaners, as other cleaners such as Low-VOC UN-TACK will react adversely with the primers, rendering the spray gun and hose unusable.



Application

- Adjust the spray gun stop nut and trigger lock to half throttle.
- Spray a small puddle of primer onto the surface to be primed. "Wet out" the roller cover with the primer.
- Begin the primer application by triggering the gun and rolling the assembled apparatus on the membrane at a walking speed that allows you to maintain a controlled and straight line. A back and forth action may be necessary depending on how wide the primer needs to be applied. Trigger the gun as needed to keep the roller cover wet with primer. Continue to apply the primer, making sure that there will be no dry edges once the pressure-sensitive tape product is in place.
- Any time the spray gun is idle the trigger lock should be engaged.
- The tank valve should remain open until the contents in the tank are spent or when the hose is to be flushed with cleaner.

Storage and Cleaning

- Store cylinders in a protected, conditioned space with temperatures maintained between 70°F (21°C) and 100°F (38°C). Do not store or heat cylinders where temperatures reach 110°F or higher. Contents are flammable.
- Semi-daily use of the primer will not require the tank valve to be closed between uses. The tank valve should remain open and the system pressurized until you are ready to clean and flush the system. Keeping the gun, tip and hose clean is important for long term performance. Flush the gun and hose with CAV-PRIME Low-VOC Cleaner (341407) if the equipment is going to be idle for more than a few days.
- To clean the gun and hose, close the tank valve on the primer cylinder. Relieve hose and gun pressure by triggering the gun into a trash bag.
- When the pressure is relieved, remove the hose from the tank using a 9/16" open end wrench or an adjustable wrench. Thread the hose onto the CAV-PRIME Low VOC Hose and Gun Cleaner cylinder (341407) and tighten the hose with the wrench.
- Open the valve on the CAV-PRIME Cleaner canister and begin flushing the primer out of the gun and hose with the cleaner. The primer is flushed from the gun and hose when a light fan pattern is formed, and the spray is completely clear.
- Store the gun and hose as is or disconnect it from the cleaner after relieving pressure.

NOTE: Only use CAV-PRIME Low-VOC Hose and Gun Cleaner (341407) for cleaning the CAV-PRIME gun and hose. Never use Low-VOC UN-TACK or PVC UN-TACK. Do not interchange cleaners as other cleaners will react adversely with the primers, rendering the spray gun and hose unusable

General Tips, Tricks and Precautions

1. Ideal jobsite storage temperatures and cylinder performance are between 70°F (21°C) and 100°F (38°C).
2. To keep cylinders warm in cold weather, use a hot box or heated blanket where temperature can be regulated and does not reach above 100°F. Do not use standard heat bands as they do not have temperature controls and can overheat the cylinders.
3. Utilize the perforated cut out in cardboard box for easier hose installation to on/off valve.
4. When using the backpack, the 6' material hose (304302) works best to prevent excess hose from getting in the way during application.
5. Regulate primer flow through gun by adjusting stop nut/trigger lock to approximately half throttle. This will reduce splashing of the primer as it is being sprayed onto the membrane.
6. Position the CAV-PRIME applicator attachment clamps so that nozzle of the spray gun is just above the roller cover (approx. 2-3" away) so that it is close to the roof surface and spraying in front of the roller while walking forward.



CAV-PRIME Hose and Gun Cleaner

Overview

CAV-PRIME Low-VOC Hose & Gun Cleaner is designed to clean the spray guns and hoses used to apply CAV-PRIME primers. It can also be used to remove primer from various surfaces including single-ply membranes, accessories, and metal. CAV-PRIME Low-VOC Hose & Gun Cleaner is VOC compliant in all 50 states. It can be used to clean spray gun tips and allows for easy cleanup of excess primer.

To Clean Hose and Gun for Storage

Turn off the valve on the CAV-PRIME cylinder and depressurize the hose & gun. Lock the spray gun trigger, remove the hose from the CAV-PRIME cylinder, and attach to the cleaner cylinder. Open valve, unlock trigger, and aim gun away from people. Trigger gun into a trash bag or vessel for 10-15 seconds, or until spray is completely clear. Turn off valve on cleaner and depressurize the hose and gun before removing for storage. To Clean Up Excess Primer: Spray directly on primer to be removed and wipe with cloth. Can also spray on cloth and wipe. Wear protective, solvent resistant gloves and goggles when cleaning.

Precautions

Flammable liquid, propellant, and vapor. Keep away from open flame. Use with adequate ventilation. Avoid inhalation of spray mist and vapors. Harmful or fatal if swallowed. May cause eye irritation. Keep out of reach of children. Use of goggles and gloves recommended. Cylinders are not refillable and when empty are harmless and disposable. Dispose of according to local codes and laws. Keep cans and cylinders below 100°F (37°C)



CAV-PRIME Low-VOC EPDM and TPO Primer

CAV-PRIME Low-VOC EPDM & TPO Primer is Carlisle's Low-VOC membrane primer packaged in a pressurized cylinder for spray application. Low-VOC Primer is a solvent-based product designed for one-step priming of EPDM or TPO surfaces prior to the application of Factory-Applied Tape, Coverstrip, SecurTAPE™ and all other pressure-sensitive (PS) products. This product is designed to comply with VOC regulations. CAV-PRIME is applied via a self-contained spray system coupled with a spray gun with extension wand and applicator attachment kit. CAV-PRIME spray guns, hoses, and applicator attachment kits are each sold separately.

Coverage Rate: Approximately 1,760 ft²/cylinder (163.5 m²) can be expected on Kleen EPDM and TPO membrane. Do not use with standard (dusted) EPDM membrane without cleaning.

Packaging: # 20 small cylinder – Product # 341449

TPO Primer ■



A high-solids, clear polymer-based primer used to prepare TPO membrane prior to the application of Pressure-Sensitive (PS) products.

Coverage Rate: 200 – 250 square feet (one surface) per gallon.

Packaging: (6) 1-gallon cans

Product Number: 310471

Shelf Life: 12 months unopened can

One-Part Pourable Sealer ■ ■



A single-component, moisture-curing, elastomeric polyether sealant that is compatible with Carlisle's TPO and PVC membranes. Designed to provide a flexible, durable and long-lasting seal around hard-to-

flash penetrations. The sealant's consistency allows for quick pocket filling without mixing. Unused sealant is usable for up to 30 days if pouch is resealed with original cap.

Coverage Rate: 122 cubic inches of volume per 1/2-gallon pouch.

Packaging: (4) 1/2-gallon pouches per bucket

Product Number:

307647 – Black

307603 – White

Shelf Life: 12 months unopened container

Cut-Edge Sealant ■



TPO Cut-Edge Sealant

A clear, free-flowing polymeric material designed for sealing cut edges (exposed fabric) of Sure-Weld TPO membrane.

Packaging: (8) 16-oz. Bottles/carton

Product Number: 303436 – Clear

Shelf Life: 12 months

Coverage Rate: 225' – 275' per 16-oz. bottle when applied with 1/8" bead.

PVC Cut-Edge Sealant ■

Also available (not shown)

PVC Cut-Edge Sealant can be used for sealing cut edges (exposed fabric) of Sure-Flex PVC membrane. Cut-Edge Sealant is clear in color.

Packaging: (12) 16-oz. Bottles/carton

Product Number: 307754

Shelf life: 12 months

Coverage Rate: 225'-275' per bottle when applied with 1/8" bead.

** Certain restrictions apply, see Product Data Sheet.

■ Sure-Weld TPO
■ Sure-Flex PVC

Low-VOC PVC Step 1 Activator



A high-strength, solvent-based activator that is applied to Sure-Flex PVC or KEE HP membranes prior to application of the primer. This essential component allows the use of PVC Pressure-Sensitive Cover Strip with PVC or KEE HP

membranes. It is specially formulated using a blend of VOC-exempt solvents.

Coverage Rate: 250 to 300 square feet (23.2 to 27.9 m²) per gallon finished surface

Packaging: (2) 1 gallon (3.8 liters) cans per carton

Product Number: 332651

Shelf Life: 1 year

PVC Step 2 Primer



A high-solids-content, clear (translucent color), polymer-based splice primer that promotes the adhesive of the PVC PS Cover Strip to PVC and KEE HP membranes.

Coverage Rate: 200–250 square feet (19–24 m²) per gallon (one surface)

Packaging: 2 each 1-gallon cans per carton

Product Number: 332653

Shelf Life: 1 year

Low-VOC PVC Step 2 Primer



A high-solids-content, clear (translucent color), Low-VOC polymer-based splice primer that promotes the adhesive of the PVC PS Cover Strip to PVC and KEE HP membranes.

Coverage Rate: 200–250 square feet (19–24 m²) per gallon (one surface)

Packaging: (2) 1-gallon (3.8 liters) cans per carton

Product Number: 332652

Shelf Life: 1 year

Universal Single-Ply Sealant



A 100%-solids, solvent-free, one-part, polyether sealant that provides a weathertight seal to a variety of building substrates.

Coverage Rate: 25' per tube or 600' per carton using a ¼" bead.

Packaging: 24 Tubes/carton

Product Number:

310131

349227 - Gray

Shelf Life: 12 months

unopened container

(@ <90°F)

Water Cut-Off Mastic



A one-component, low-viscosity, self-wetting, butyl-blend mastic used in conjunction with roofing and waterproofing systems. It is used as a sealing agent between various membranes and substrates for compression-type terminations.

Coverage Rate: 10' per tube, using a 7/16" bead.

Packaging: 25 Tubes/carton

Product Number: 319621

Shelf Life: 12 months

unopened container

■ Sure-Weld TPO

■ Sure-Flex PVC

Thermoplastic Accessories

Reinforced Overlay



Pre-slit reinforced membrane used to overlay fasteners, plates, and end laps on FleeceBACK and Self-Adhering Technology (SAT) membranes.

TPO

Sizes Available:

45-mil

6" x 100' – Product Number: 300485 – White
6" x 100' – Product Number: 300486 – Gray
6" x 100' – Product Number: 302811 – Tan

60-mil

6" x 100' – Product Number: 325005 – White
6" x 100' – Product Number: 325003 – Gray
6" x 100' – Product Number: 325004 – Tan
9" x 50' – Product Number: 310419 – White
9" x 50' – Product Number: 310417 – Gray
9" x 50' – Product Number: 310418 – Tan

80-mil

9" x 50' – Product Number: 318404 – White

Quantity Per Box: 3 rolls (6"), 2 rolls (9")

Non-Reinforced Flashing



Non-reinforced thermoplastic membrane used to field-fabricate pipe flashings and scuppers when the use of a pre-molded accessory is not feasible.

TPO

Sizes Available:

12" x 50' – Product Number: 300473 – White
12" x 50' – Product Number: 300479 – Gray
12" x 50' – Product Number: 300476 – Tan
24" x 50' – Product Number: 300474 – White
24" x 50' – Product Number: 300480 – Gray
24" x 50' – Product Number: 300477 – Tan
24" x 50' – Product Number: 332963 – Medium Bronze
24" x 50' – Product Number: 328056 – Rock Brown
24" x 50' – Product Number: 328047 – Terra Cotta
24" x 50' – Product Number: 328053 – Slate Gray
24" x 50' – Product Number: 328050 – Patina Green

Quantity Per Box: 1 roll

PVC / KEE HP

Sizes Available:

12" x 50' – Product Number 327840 – White/Gray
12" x 50' – Product Number 327842 – White/Tan
24" x 50' – Product Number 327841 – White/Gray
24" x 50' – Product Number 327843 – White/Tan

Quantity Per Box: 1 roll

TPO Pressure-Sensitive RUSS

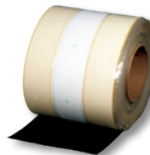

Available in 10" RUSS (shown) and used in place of narrow-width sheets to secure membrane in the perimeter of the roof on mechanically fastened systems. 6" RUSS is also available and is used to secure membrane at the base of vertical walls for additional membrane securement without penetrating the sheet.

Sizes Available:

6" x 100' – Product Number: 303373
10" x 100' – Product Number: 305442

Quantity Per Box: 1 roll (10"), 2 rolls (6")

 Sure-Weld TPO
 Sure-Flex PVC

TPO Pressure-Sensitive Coverstrip ■

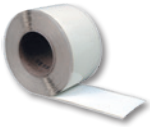

Non-reinforced TPO laminated to pressure-sensitive tape used for stripping in flat metal flanges such as shop-bent drip edge.

Sizes Available:

- 6" x 100' – Product Number: 303102 – White
- 6" x 100' – Product Number: 303103 – Gray
- 6" x 100' – Product Number: 303104 – Tan

Quantity Per Box: 2 rolls

TPO Yellow PS Warning Strip ■



TPO Yellow PS Warning Strip can be used on TPO to indicate roof edges or other hazards.

Sizes Available:

- 6" x 100' – Product Number: 325721

Quantity Per Box: 2 rolls

PVC Yellow PS Warning Strip ■



PVC Yellow PS Warning Strip can be used on PVC and KEE to indicate roof edges or other hazards. It must be used in conjunction with PVC Step 1 Activator and PVC Step 2 Primer.

Sizes Available:

- 6" x 100' – Product Number: 325721

Quantity Per Box: 2 rolls

PVC Reinforced Cover Strip ■



Carlisle's PVC Reinforced Cover Strip is an 8" (20.3 cm)-wide, nominal 60-mil (1.52 mm) and 80-mil (2.03 mm)-thick flashing that contains a polyester reinforcing fabric. PVC Reinforced Cover Strip is used for stripping in rows of fasteners and plates and covering the butt joints of Carlisle PVC and KEE HP membranes.

PVC / KEE HP

Sizes Available:

- 8" x 75' – Product Number: 325165 – White (.80-mil KEE HP Reinforced)
- 8" x 75' – Product Number: 325167 – Gray (.80-mil KEE HP Reinforced)
- 8" x 75' – Product Number: 326120 – Tan (.80-mil KEE HP Reinforced)
- 8" x 75' – Product Number: 325168 – White (.80-mil PVC Reinforced Coverstrip)
- 8" x 75' – Product Number: 325169 – Gray (.80-mil PVC Reinforced Coverstrip)
- 8" x 75' – Product Number: 326121 – Tan (.80-mil PVC Reinforced Coverstrip)
- 8" x 100' – Product Number 325981 – White (.60-mil KEE HP Reinforced)
- 8" x 100' – Product Number: 348090 - White (.60-mil PVC Reinforced)
- 8" x 100' - Product Number: 348090 - White (.60-mil PVC Reinforced)

Quantity Per Box: 2 rolls (60-mil), 1 roll (80-mil)

PVC PS Cover Strip ■



A nominal 35-mil (0.76 mm) non-reinforced KEE HP flashing laminated to a nominal 35-mil (0.76 mm), fully cured, pressure-sensitive, synthetic rubber adhesive. PVC PS Cover Strip is exclusively tested and designed for use on Carlisle Sure-Flex PVC and KEE HP membranes.

PVC

Sizes Available:

- 6" x 100' – Product Number – 332616 – White
- 6" x 100' – Product Number – 332617 – Gray
- 6" x 100' – Product Number – 332618 – Tan

- Sure-Weld TPO
- Sure-Flex PVC

Split Pipe Seals



Fabricated using 60-mil reinforced Sure-Weld detail membrane and Sure-Flex membranes, split pipe seals are designed to flash pipes with obstructions that prevent the use of a molded seal.

A split and overlap tab allow

the flashings to be opened and wrapped around the penetration. Other sizes and colors available through special order.

TPO

Sizes Available:

- 1" – Product Number: 303504 – White
- 1" – Product Number: 307654 – Gray
- 1" – Product Number: 307648 – Tan
- 2" – Product Number: 303505 – White
- 2" – Product Number: 307655 – Gray
- 2" – Product Number: 307649 – Tan
- 3" – Product Number: 303506 – White
- 3" – Product Number: 307656 – Gray
- 3" – Product Number: 307650 – Tan
- 4" – Product Number: 303507 – White
- 4" – Product Number: 307657 – Gray
- 4" – Product Number: 307651 – Tan
- 5" – Product Number: 303508 – White
- 5" – Product Number: 307658 – Gray
- 5" – Product Number: 307652 – Tan
- 6" – Product Number: 303509 – White
- 6" – Product Number: 307659 – Gray
- 6" – Product Number: 307653 – Tan

Quantity Per Box: 8

PVC

Sizes Available:

- 1" – Product Number: 307724 – White
- 1" – Product Number: 307725 – Gray
- 1" – Product Number: 307726 – Tan
- 2" – Product Number: 307727 – White
- 2" – Product Number: 307728 – Gray
- 2" – Product Number: 307729 – Tan
- 3" – Product Number: 307730 – White
- 3" – Product Number: 307731 – Gray
- 3" – Product Number: 307732 – Tan
- 4" – Product Number: 307733 – White
- 4" – Product Number: 307734 – Gray
- 4" – Product Number: 307735 – Tan
- 5" – Product Number: 307736 – White
- 5" – Product Number: 307737 – Gray
- 6" – Product Number: 307739 – White
- 6" – Product Number: 307740 – Gray

Quantity Per Box: 8

Square Tubing Wraps



Fabricated using 60-mil reinforced Sure-Weld detail membrane and Sure-Flex wraps are designed to flash square metal tubing. A split and overlap tab allow the flashings to be opened

and wrapped around a square penetration with an obstruction. Other sizes and colors available through special order.

TPO

Sizes Available:

- 3" x 3" – Product Number: 305576 – White
- 3" x 3" – Product Number: 307664 – Gray
- 3" x 3" – Product Number: 307660 – Tan
- 4" x 4" – Product Number: 305577 – White
- 4" x 4" – Product Number: 307665 – Gray
- 4" x 4" – Product Number: 307661 – Tan
- 5" x 5" – Product Number: 305578 – White
- 5" x 5" – Product Number: 307666 – Gray
- 5" x 5" – Product Number: 307662 – Tan
- 6" x 6" – Product Number: 305579 – White
- 6" x 6" – Product Number: 307667 – Gray
- 6" x 6" – Product Number: 307663 – Tan

Quantity Per Box: 8

PVC

Sizes Available:

- 3" x 3" – Product Number: 307742 – White
- 3" x 3" – Product Number: 307743 – Gray
- 4" x 4" – Product Number: 307745 – White
- 4" x 4" – Product Number: 307746 – Gray
- 6" x 6" – Product Number: 307748 – White
- 6" x 6" – Product Number: 307749 – Gray

Quantity Per Box: 8

■ Sure-Weld TPO
■ Sure-Flex PVC

Molded Pipe Seals



Injection-molded, pre-formed pipe flashings for pipes $\frac{3}{4}$ " to 8" diameter. Molded Pipe Seals provide a reliable method of waterproofing round pipe penetrations,

as well as a substantial labor savings compared to field-fabrication.

TPO

Sizes Available:

$\frac{3}{4}$ " – 8" diameter – Product Number: 316534 – White

$\frac{3}{4}$ " – 8" diameter – Product Number: 316535 – Gray

$\frac{3}{4}$ " – 8" diameter – Product Number: 316536 – Tan

Quantity Per Box: 8

PVC

Sizes Available:

$\frac{3}{4}$ " – 8" diameter – Product Number: 316537 – White

$\frac{3}{4}$ " – 8" diameter – Product Number: 322959 – Gray

$\frac{3}{4}$ " – 8" diameter – Product Number: 323823 – Tan

$\frac{3}{4}$ " – 8" diameter – Product Number: 348093 – Light Gray

Quantity Per Box: 8

Molded Sealant Pockets



Interlocking, two-piece, injection-molded, weldable pockets used to waterproof pipe clusters or other oddly shaped penetrations.

TPO

Sizes Available:

6" wide x 2" high

Can be adjusted from $7\frac{1}{2}$ " to $11\frac{1}{2}$ " in length

Product Number: 316539 – White

Product Number: 316540 – Gray

Product Number: 316541 – Tan

Quantity Per Box: 5 complete pockets

PVC

Sizes Available:

6" wide x 2" high

Can be adjusted from $7\frac{1}{2}$ " to $11\frac{1}{2}$ " in length

Product Number: 316542 – White

Quantity Per Box: 5 complete pockets

Curb Wrap Corners

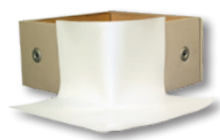

Prefabricated flashings made of 60-mil reinforced Sure-Weld detail membrane designed to reduce curb flashing time.

Each corner has a 6"-wide base flange and a 12" overall height. One curb will require 4 corners. Other sizes and colors available through special orders. Available in 1- or 2-piece wraps.

TPO

Sizes Available:

7" Wrap for 12" Curb –

Product Number: 305062 – White

13" Wrap for 24" Curb –

Product Number: 305063 – White

19" Wrap for 36" Curb –

Product Number: 305064 – White

Quantity Per Box: 12 pieces or 3 complete curbs

PVC

Sizes Available:

7" Wrap for 12" Curb –

Product Number: 322973 – White

Product Number: 322970 – Gray

Product Number: 322977 – Tan

13" Wrap for 24" Curb –

Product Number: 322975 – White

Product Number: 322971 – Gray

Product Number: 322978 – Tan

19" Wrap for 36" Curb –

Product Number: 322976 – White

Product Number: 322972 – Gray

Product Number: 322979 – Tan

Quantity Per Box: 12 pieces or 3 complete curbs

■ Sure-Weld TPO

■ Sure-Flex PVC

Universal Corners



Pre-molded corners, used for flashing outside or inside corners on new construction installations where right-angled conditions are more common. Installation is fast and easy with no stretching required.

TPO

Sizes Available: One Size
Product Number: 318070 – White
Product Number: 327601 – Gray
Product Number: 327602 – Tan

Quantity Per Box: 20

PVC

Sizes Available: One Size
Product Number: 318071 – White
Product Number: 329288 – Gray
Product Number: 329289 – Tan
Product Number: 348092 – Light Gray

Quantity Per Box: 20

Inside/Outside Corners



Pre-molded corners, used for flashing inside and outside corners on a variety of details.

TPO

Sizes Available: One Size
Product Number: 300016 – White – Outside
Product Number: 300020 – Gray – Outside
Product Number: 300025 – Tan – Outside
Product Number: 307406 – White – Inside
Product Number: 307408 – Gray – Inside
Product Number: 307407 – Tan – Inside

Quantity Per Bag: 12

PVC

Sizes Available: One Size
Product Number: 329286 – White/Gray – Outside
Product Number: 329284 – White/Gray – Inside
Product Number: 329287 – White/Tan – Outside
Product Number: 329285 – White/Tan – Inside

Quantity Per Bag: 12

Contour Rib™



This profile is extruded from the same weather-resistant TPO or PVC compound as the membrane. The Contour Rib Profile is secured to the TPO or PVC roofing membrane to simulate a standing seam metal roofing system. The physical dimensional stability of the profile is enhanced with fiberglass and the rectangular profile provides exceptional shadow lines for aesthetic appeal.

TPO

Sizes Available:
10' – Product Number: 324572 – White
10' – Product Number: 324573 – Gray
10' – Product Number: 324574 – Tan
10' – Product Number: 333064 – Medium Bronze
10' – Product Number: 330830 – Rock Brown
10' – Product Number: 330797 – Terra Cotta
10' – Product Number: 330799 – Slate Gray
10' – Product Number: 330798 – Patina Green

Quantity Per Box: 20

PVC

Sizes Available:
10' – Product Number: 321909 – White
10' – Product Number: 321911 – Gray
10' – Product Number: 321910 – Tan
10' – Product Number: 334438 – Light Gray
10' – Product Number: 335822 – Slate Gray

Quantity Per Box: 20

■ Sure-Weld TPO
■ Sure-Flex PVC

Walkway Rolls ■ ■

Heat-weldable walkway rolls designed to protect Carlisle's TPO and PVC membranes in areas exposed to repetitive foot traffic and other hazards.

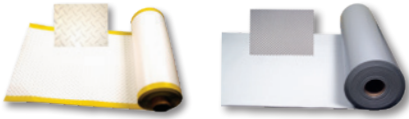

TPO

Sizes Available:

34" x 50' – Product Number: 310508 – White

34" x 50' – Product Number: 310509 – Gray

34" x 50' – Product Number: 310510 – Tan

TPO Crossgrip Walkway Rolls

3' x 33' - Product Number: 332633 - White

3' x 33' - Product Number: 332634 - Gray

3' x 33' - Product Number: 341122 - Yellow

Packaged Individually

PVC

Sizes Available:

36" x 60' – Product Number: 307711 – Gray

PVC Crossgrip Walkway Rolls

3' x 33' - Product Number: 332475 - White

3' x 33' - Product Number: 332474 - Gray

3' x 33' - Product Number: 340355 - Yellow

Packaged Individually

T-Joint Covers ■ ■



Injection-molded non-reinforced flashings used to seal T-Joint splice intersections.

TPO

Sizes Available:

4½" diameter – Product Number: 307476 – White

4½" diameter – Product Number: 307478 – Gray

4½" diameter – Product Number: 307477 – Tan

Quantity Per Box: 100

PVC

Sizes Available:

4½" diameter – Product Number: 308224 – White

4½" diameter – Product Number: 309494 – Gray

4½" diameter – Product Number: 309847 – Tan

Quantity Per Box: 100

Coated metal ■ ■



24-gauge (0.6 mm) galvanized steel sheets coated with a layer of .035" non-reinforced flashing. Membrane may be welded directly to the coated metal. The

sheet is cut to the appropriate width and used to fabricate metal drip edges or other roof perimeter edging profiles. TPO and PVC Coated Metal is available in special colors.

TPO

Sizes Available:

10 Pcs/Pallet –

4' x 10' – Product Number: 309272 – White

4' x 10' – Product Number: 309273 – Gray

4' x 10' – Product Number: 309274 – Tan

25 Pcs/Pallet –

4' x 10' – Product Number: 303181 – White

4' x 10' – Product Number: 303183 – Gray

4' x 10' – Product Number: 303182 – Tan

5 Pcs/Pallet

4' x 10' - Product Number: 332916 - Medium Bronze

4' x 10' - Product Number: 332913 - Rock Brown

4' x 10' - Product Number: 332915 - Terra Cotta

4' x 10' - Product Number: 332914 - Slate Gray

4' x 10' - Product Number: 332912 - Patina Green

PVC

Sizes Available:

10 Pcs/Pallet –

4' x 10' – Product Number: 307708 – White

4' x 10' – Product Number: 307709 – Gray

4' x 10' – Product Number: 307710 – Tan

4' x 10' – Product Number: 334438 – Light Gray

4' x 10' - Product Number: 335822 - Slate Gray

■ Sure-Weld TPO

■ Sure-Flex PVC

SECTION 3: TOOLS & EQUIPMENT

Use Proper Generators

Use commercial-grade generators only. Required generator wattage follows:

- 6,500 watts – 1 Auto- Welder
- 3,000 watts – 2 Hand- Welders



Use Proper Gauge Extension Cords

- Auto Welders: 10 Gauge Wire- 100' maximum length
- Hand Welders: 12 Gauge Wire- 100' maximum length



10 Gauge Wire



12 Gauge Wire

Welding for Step-offs

1. Crease membrane into step-offs
2. Use 2" silicone roller
3. Complete immediately after auto-welder crosses seam intersection

NOTE: Prevents formation of a water channel



Probe All Seams at the End of Each Day

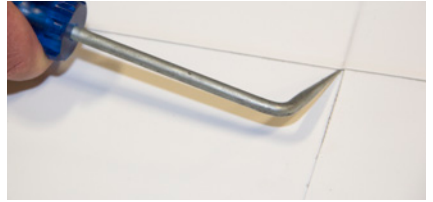

Clean Nozzle Regularly with Brass Wire Brush

- Confirm air outlet holes on top and bottom of nozzle are unobstructed.



Keep Air Intake Free From Debris

- Clean dirt and debris from heat gun air intake daily. This allows for maximum airflow.



Dirt and debris in intake



Clean intake

TPO Membrane: Auto-Welder Ideal Set-Up Parameters

Leister Varimat

Welding Temperature..... 1,004°F
Speed..... 12.5 feet per minute
Airflow..... 100%

BAK LarOn

Welding Temperature..... 1,004°F
Speed..... 12.5 feet per minute
Airflow..... 100%

Leister V2 (TPO2 Preset)

Welding Temperature..... 986°F
Speed..... 18 feet per minute
Airflow..... 90%

Recommended Settings for Auto-Welders Not Shown

Welding Temperature..... 1,000°F
Speed..... 12 feet per minute
Airflow..... 100%

TPO Membrane: Hand-Held Welder Ideal Set-Up Parameters

Hand-Held Welder

Flashing..... Set temperature setting at “6”
Membrane..... Set temperature setting at “8”

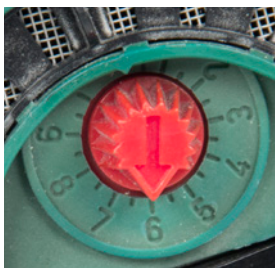

PVC Membrane: Auto-Welder Ideal Set-Up Parameters

Leister Varimat

Welding Temperature..... 1,094°F
Speed 8.5 feet per minute
Airflow 100%

Leister V2

Welding Temperature..... 1,094°F
Speed..... 10.4 feet per minute
Airflow 75%

BAK LarOn

Welding Temperature..... 1,094°F
Speed..... 8.5 feet per minute
Airflow 100%

BAK LarOn 21

Welding Temperature..... 1,100°F
Speed..... 13.5 feet per minute
Airflow 100%

Smoke Reduction Welding

Welding Temperature..... 900°F
Speed..... 9.5 feet per minute
Airflow 100%

Recommended Settings for Auto-Welders Not Shown

Welding Temperature..... 1,100°F
Speed..... 12 feet per minute
Airflow 100%

PVC Membrane: Hand-Held Welder Ideal Set-Up Parameters

Hand-Held Welder

FlashingSet temperature setting at “7”
MembraneSet temperature setting at “8”

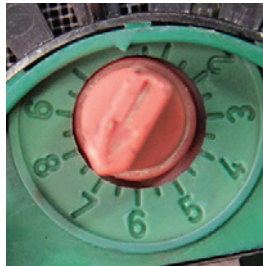

SECTION 4: COMMON INSTALLATION ISSUES

Reduce the chance for cold welds on TPO membranes:

- A good starting point for welding all types and thickness of Sure-Weld TPO on auto-welders is 1,000°F at 12"/minute with airflow at 100%. Hand welding flashing the welder should be set at #7 and for membrane set at #8. A proper hot air welded seam has no voids or wrinkles and must be a least 1½" wide.
- Perform a test weld at the start of each morning and afternoon on a piece of like membrane over the same substrate.
- Mark the end of the hot air welded seam with a water-soluble marker for easy identification. A hand-held welder will be necessary to complete the weld in the area between where the automatic welder stopped and restarted.
- Weld all seams prior to the end of the work day. Any blown-in contamination or moisture must be removed using a Splice Wipe soaked with Weathered Membrane Cleaner. Seams that are not welded within 24 hours should be cleaned with a Splice Wipe soaked with Weathered Membrane Cleaner regardless of conditions. Allow the cleaned area to vent for at least 10 minutes prior to welding again.
- Welding aged membrane (over 1-year and longer) may require the use of a Primer Pad and Weathered Membrane Cleaner. Work up a slurry using the Primer Pad and Weather Membrane Cleaner. Using a Splice Wipe remove the residue from the cleaned area. Wipe the membrane again using a clean Splice Wipe and Weathered Membrane Cleaner. Allow the cleaned area to vent for at least 10 minutes prior to welding.

Seam Probing:

- Probing seams must be done once hot air welds have thoroughly cooled (min. 20 minutes). Hot air weld seams must be probed throughout the day to check seam quality and to make proper adjustments to hot air welding equipment. The repair of deficiencies must be done routinely throughout the day but no later than the end of each workday.

Membrane Securement:

- Membrane securement must be installed at perimeters of each roof level, curbs, skylights, expansion joints and all inside deck angle changes greater than 2" in 12".
- Membrane securement is also required around all pipe penetrations and sealant pockets regardless of size on mechanically fastened systems. On adhered systems only when the pipe diameter exceeds 18" in size or the sealant pocket exceeds 12" in size is membrane securement required.

Overheated Welds:

- Overheating of welds is evident when "bleed-out" occurs. Bleed-out is the dark underside of the membrane that begins to melt and flow. Bleed-out will not occur with Sure-Weld TPO membrane if properly welded.
- If overheating is evident, a piece of non-reinforced flashing may be used for a repair. The non-reinforced flashing should overlay the deficiency 2" in all directions and be welded 100%.

Reduce the chance for cold welds on PVC membranes:

- When cleaning PVC it is important to allow the solvents from the PVC Membrane Cleaner to thoroughly flash-off prior to welding. This will take up to 15 minutes to occur. If this procedure is rushed the PVC membrane may exhibit cold welding. Cold welding is defined as a weld that is not properly fused together, allowing the weld area to separate after natural expansion and contraction occurs in the roofing system.

- Perform a test weld at the start of each morning and afternoon on a piece of like membrane over the same substrate.
- A good starting point for welding all types and thickness of Sure-Flex PVC on auto-welders is 1,094°F. at 8.9'/ minute. Using the Leister V-2 welder the speed can be utilized up to 10.2'/ minute.
- A proper weld for PVC will exhibit a little bit of bleed-out at the overlap step-off. Bleed-out is when the darker bottom ply actually starts to flow from the heat melting the sheet.
- Welding PVC membranes that are 5-7 years or older category may be difficult to achieve proper fusion. You may have to utilize the bottom side of the older sheet that has not seen weathering and is generally more stable for welding.
- When probing PVC make sure the membrane is thoroughly cooled. Proceed with probing making sure the probe point is duller and has a flatter point compared to TPO probing.

SECTION 5: STAGING & STORAGE BEST PRACTICES

General

- Perimeter warning lines and safety equipment must be in place per OSHA requirements prior to beginning any of the following roof activity.
- Before staging material, an assessment of the roof should be conducted to determine work flow, staging areas, weak spots, structural layout and placement of rolls and insulation.

Insulation

- Insulation and underlayment must be stored so it is kept dry and protected from the elements. Store bundles flat and upright with the bottom of the bundles elevated (2" or more) above a finished surface.
- Slit the insulation bundle packaging vertically down the center of the two short sides to prevent moisture accumulation within the package. Completely cover the bundle with a waterproof tarp and secure to prevent wind damage and/or displacement.

Adhesives/Primers

- Keep these products between 60°F – 80°F (15.6°C – 26.7°C) for best results and ease of application.
- Jobsite storage more than 90°F (32°C) may affect product shelf life. Prolonged exposure to below-freezing temperatures will cause the adhesive to thicken and eventually solidify in the can. Should the Low-VOC Bonding Adhesive be stored below freezing, restore to room temperature for a minimum of 24 hours prior to use; the adhesive will perform as intended once it is returned to a liquid state. When temperatures are expected to be consistently below 40°F (4.4°C), a heated enclosure or hot box is recommended for jobsite storage. Keep the adhesive between 60°F – 80°F (15.6°C – 26.7°C) for ease of application.
- Products are EXTREMELY FLAMMABLE. It contains solvents that are dangerous fire and explosion hazards when exposed to heat, flame or sparks. Do not smoke while applying. Do not use in a confined or unventilated area. Vapors are heavier than air and may travel along ground or may be moved by ventilation and ignited by pilot lights, other flames, sparks, heaters, smoking, electrical motors, static discharge or other ignition sources at locations distant from material handling point and flashback. Use only non-sparking tools. All containers should be grounded when material is transferred from one container to another. A red caution label is required when shipping. A fire extinguisher should be available. In case of fire, use water spray, foam, dry chemical or carbon dioxide. Do not use a solid stream of water, because it can scatter and spread the fire.
- These materials are sensitive to atmospheric moisture; heat will accelerate the effect of moisture. Opened containers of bonding adhesive should be used within 48 hours. Adhesive will begin to thicken after this point, making it difficult, and eventually impossible, to control adhesive thickness.

CAV-GRIP III Low-VOC Adhesive/Primer

- Store cylinders in protected, conditioned space with temperature maintained above 70°F (21°C). Do not store cylinders in areas where temperatures reach 110°F (43.3°C) or higher. Contents are flammable. Store in accordance with local, state, and federal regulations.

Membrane and Flashing

- Store TPO, PVC & KEE membrane in the original undisturbed plastic wrap and cover with light colored, breathable tarpaulins. TPO, PVC & KEE flashing should also be stored in the original packaging in the same manner.
- SAT TPO membrane must be stored in the original undisturbed plastic wrap in a cool, shaded area and cover with light-colored, breathable, waterproof tarpaulins. SAT TPO membrane that has been exposed to the weather must be prepared with Weathered Membrane Cleaner prior to hot-air welding. SAT membrane must be installed at ambient temperatures above 50°F (10°C).
- FleeceBACK, FleeceBACK RL™, FleeceBACK AFX TPO, PVC & KEE and FleeceBACK FR TPO membrane rolls must be tarped and elevated to keep dry prior to installation. If the fleece gets wet, use a wet-vac system to help remove moisture from the fleece. Do not install membrane if fleece is wet. If any of the membrane is exposed to the weather must be prepared with the appropriate Weathered Membrane Cleaner prior to hot-air welding.
- When positioning the rolls on the roof pay attention to the “unroll” labels found on each individual roll to reduce the need for repositioning.

Pressure-Sensitive Products

- TPO pressure sensitive products to include TPO P.S. Coverstrip, Warning Strip and RUSS must not be prolonged to jobsite storage temperatures more than 90°F (32.2°C) may affect product shelf life. In warm, sunny weather, keep TPO PS Coverstrip rolls in their box or in a shaded area until ready to use. Storage and use of TPO PS Coverstrip at temperatures below 40°F (4.4°C) will result in a loss of adhesive tack, and in extreme cases will result in an inadequate bond to the substrate. Overnight storage must be available to keep the temperature of the TPO PS Coverstrip at a minimum of 40°F (4.4°C). Hot boxes for jobsite storage must be provided to maintain a minimum product temperature of 40°F (4.4°C). TPO PS Coverstrip must be stored in a dry area.

TPO, PVC and KEE Accessories

- Thermoplastic accessories to include molded and prefabricated products should be stored in a cool, shaded area and cover with light colored, breathable, waterproof tarpaulins. Thermoplastic accessories exposed to the weather must be prepared with the appropriate Weathered Membrane cleaner prior to hot-air welding.
- LIQUISEAL Liquid Flashing products are to be stored in a cool, dry location between 35°F – 80°F (1.7°C – 26.7°C). Do not store in direct sunlight. Approximate shelf life is 12 months with proper storage. Best practice is to store material at 65°F – 70°F (18.3°C – 21.1°C) for 24 hours before use. Do not install if ambient temperature is below 40°F (4.4°C) or above 90°F (32.2°C).

SECTION 6: EXECUTION/INSTALLATION PROCEDURE

Sure-Weld® TPO Roofing Systems

Mechanically Fastened and Adhered Roofing Systems

JULY 2023

The information contained in this generic specification represents a part of Carlisle's requirements for obtaining a roofing system warranty. Construction materials and practices, building siting and operation, climatic conditions, and other site-specific factors will have an impact on the performance of the roofing system. Carlisle recommends that the building owner retain a design professional to determine appropriate design measures to be taken in order to address these factors.

This section is to serve as criteria for Specifiers and Authorized Applicators regarding the design and installation of Carlisle's Adhered and Mechanically Fastened TPO Membrane Roofing Systems. Additional information essential for the design and installation of the roof system mentioned herein are also included in the Design Reference Section and also listed in the form of a Specification Supplement at the end of the Technical Manual. Specifiers and Authorized Applicators are advised to reference all applicable sections.

Various Warranty Tables have been included in Paragraph 1.05 citing various requirements by which specific warranty coverage can be obtained. Appropriate Warranty Table should be referenced to ensure proper warranty coverage.

Part I – GENERAL

1.01 Description

A. Mechanically Fastened Systems (Sure-Weld)

1. The **Sure-Weld Mechanically Fastened Roofing System** incorporates 12', 10' or 8' wide, white, tan or gray in 45, 60 or 80-mil thick scrim-reinforced, Sure-Weld Thermoplastic Polyolefin (TPO) membrane field sheets (also available in special colors in 60-mil thick, maximum 10' wide sheets). The Spectro-Weld Mechanically Fastened Roofing System incorporates 10' or 6' wide, white, 60 or 80-mil thick scrim-reinforced Thermoplastic Polyolefin (TPO) membrane field sheets. Insulation is mechanically fastened to an acceptable roof deck. Sure-Weld perimeter sheets (6' used with 10' and 12' wide field sheets; 4' used with 8' wide field sheets) are installed along building edges and field membrane sheets are mechanically fastened to the roof deck with the appropriate Carlisle fasteners and fastening plates. Adjoining sheets of Sure-Weld membrane are overlapped and joined together with a minimum 1-½" wide heat weld. Membrane fastening requirements are outlined in Warranty Tables in Paragraph 1.05 of this Specification.

NOTE: The **Sure-Weld Mechanically Fastened Roofing System** may be specified using over an existing standing seam, flat seam or corrugated metal roof (mechanically fastened systems incorporate membrane securement into the structural purlins). **Refer to the Metal Retrofit Roofing System Specification**, published separately, for applicable requirements.

B. Adhered Roofing Systems (Sure-Weld / Sure-Weld SAT)

1. The **Sure-Weld Adhered Roofing System** incorporates maximum 16' wide white, gray or tan 45, 60 or 80-mil thick scrim-reinforced Sure-Weld Thermoplastic Polyolefin (TPO) membrane and special colors in 60-mil thick, 5' and 10' wide sheets). The Spectro-Weld Adhered Roofing System incorporates 10' wide, white, 60 or 80-mil thick scrim-reinforced Thermoplastic Polyolefin (TPO) membrane field sheets. Carlisle Insulation is mechanically fastened to the roof

deck or secured with Flexible FAST Adhesive, OlyBond 500 BA, or OlyBond Spot Shot Adhesive and the membrane is fully adhered to the insulation with the appropriate Sure-Weld Bonding Adhesive. Adjoining sheets of membrane are overlapped approximately 2" and joined together with a minimum 1-½" wide heat weld.

2. The **Sure-Weld SAT (Self Adhering Technology) membrane** is a heat-weldable single-ply thermoplastic polyolefin (TPO) sheet available in 10' wide, (white, tan or gray) 60 or 80-mil thick reinforced TPO membrane laminated to an elastomeric pressure-sensitive adhesive.

1.02 General Design Considerations

Various Warranty Tables have been included in Paragraph 1.05 citing various requirements by which specific warranty coverage can be obtained. Appropriate Warranty Table should be referenced to ensure proper warranty coverage.

- A. The maximum roof slope for Mechanically Fastened Roofing Systems is 18" in one horizontal foot. There are no maximum slope restrictions for the application of the Adhered Roofing System.
- B. The mechanically fastened roofing system is **not acceptable** for installations on steel decks lighter than 22 gauge unless the steel deck is used in conjunction with lightweight concrete and a minimum of 360 pounds pullout per fastener is achieved with HP-X Fasteners into the steel deck below. An Adhered Roofing System may be specified or refer to the Metal Retrofit Roofing System Specification, published separately for other roofing options.
- C. Certain petroleum based products, chemicals, and waste products may not be compatible with this roofing system. Contact Carlisle for verification of compatibility and recommendations concerning an acceptable roofing assembly.
- D. Metal-Edge Systems and Copings should be designed in compliance with Section 1504.5 of the International Building Code and shall be tested in accordance with ANSI/SPRI ES-1.
- E. Concentrated loads from rooftop equipment may cause deformation of insulation/underlayment and possible damage to the membrane if proper protection is not provided. A protection course or sleepers must be specified.
- F. It is the responsibility of the specifier to review local, state and regional codes to determine their impact on the specified Carlisle Roofing System.
- G. It is the responsibility of the building owner or his/her designated representative to verify structural load limitation. In addition, a core cut may be taken to verify weight of existing components when the roofing system is to be specified on an existing facility.
- H. For information regarding CRRC (Cool Roof Rating Council) and LEED™, refer to the applicable Product Data Sheets and Design Reference DR 07-20 "CRRC/LEED Information".
- I. **Construction Generated Moisture / Vapor Drive**
 1. On new construction projects, especially in cold climate regions, moisture generated due to the construction process could adversely impact various components within the roofing assembly if not addressed. Refer to Design Reference DR-01-21 "Construction Generated Moisture" included in the Carlisle Technical Manual.
 2. On structural concrete decks, when a vapor retarder is not used, gaps in the deck along the perimeter and around penetrations must be sealed along with vertical joints between tilt-up panels, if present, to prevent infiltration of hot humid air and possible moisture contamination resulting from condensation. This is specifically important when adhesive is used to attach the roof insulation.

NOTE: If left unaddressed, collected moisture could weaken insulation boards and facers resulting in a blow-off or increase the probability of mold growth.

J. Drainage

1. Drainage must be evaluated by the specifier in accordance with all applicable codes. Slopes may be provided by tapering the structure or through the use of tapered insulation; a sufficient number of roof drains should also be specified and properly located to allow for positive drainage. Significant ponding that could remain after 48 hours should be eliminated with the addition of auxiliary drains in low areas where ponding is anticipated.

Carlisle specifically disclaims responsibility for the design and selection of an adequate drainage system and drain accessories. Selection must be made by the building owner or the owner's design professional.

2. Small incidental areas of ponded water will not impact the performance of this roofing system; however, in accordance with industry standards, the roofing assembly **should be designed to prevent ponding** of water on the roof for prolonged periods (longer than 48 hours). Good roofing practice dictates proper drainage to prevent possible excessive live load and, in the event of a roof leak, to minimize potential interior damage to the roofing assembly and to the interior of the building.
3. **Tapered edge strips, crickets or saddles** are recommended where periodic ponding of water may occur. When the slope of the taper exceeds 2 inches to one horizontal foot, additional membrane securement at the base of the tapered edge strip will be required.
4. Subject to code requirement, it is recommended that a minimum roof slope of $\frac{1}{8}$ " per horizontal foot be provided to serve long-term aesthetics. On New Construction projects, roof drains should be positioned in areas where maximum deflection is anticipated. Slopes greater than $\frac{1}{8}$ " per foot should be considered due to possible roof deflection.

K. Retrofit - Recover Projects (when the existing roofing material is left in place)

1. The removal of existing wet insulation and membrane must be specified. The specifier shall select an appropriate and compatible material as filler for voids created by removal of old insulation or membrane.
2. Entrapment of water between old and new membrane can damage and deteriorate new insulation/underlayment between the two membranes. **If a vapor retarder or air barrier is not specified**, Carlisle recommends existing membrane be perforated to avoid potential moisture accumulation to allow for detection of moisture to enable the building owner to take corrective action. This can be accomplished by drilling approximately $\frac{3}{4}$ " diameter holes every 100 square feet in the existing built-up roof or single-ply membrane (excluding non-reinforced PVC membrane).
3. If total removal of existing non-reinforced PVC membrane is not specified, existing membrane may be cut into maximum 10' x 10' sections, when the new insulation or membrane underlayment is to be mechanically fastened.
4. Regardless of the type of membrane or assembly selected, any loose flashings at the perimeter, roof drains and roof penetrations must be removed.

1.03 Quality Assurance

Building codes are above and beyond the intended purpose of this specification. The building **owner, owner's representative or Specifier** should verify local codes for applicable requirements and limitations. It is the responsibility of the specifier to review local, state and regional codes to determine their impact on the specified Carlisle Roofing System.

NOTE: For code approvals achieved with the Carlisle Roofing Systems, refer to the Carlisle Code Approval Guide, DORA (Directory of Roof Assemblies), Factory Mutual (FM) Approval Guide or Underwriters Laboratories (UL) Fire Resistance or Roofing Materials and Systems Directories.

- A. When recovering or retrofitting an existing roof system, the addition of new insulation (type and thickness) may alter the fire performance characteristics of the assembly. Building owners or their designated representatives shall consult the local code enforcement agency to avoid potential code violation.
- B. Carlisle recommends the use of Carlisle supplied products for use with Sure-Weld Roofing Systems. The performance or integrity of products by others, **when selected by the specifier and accepted as compatible by Carlisle**, is not the responsibility of Carlisle and is **expressly disclaimed** by the Carlisle warranty.
- C. This roofing system must be installed by a Carlisle Authorized Roofing Applicator in compliance with drawings and specifications as approved by Carlisle SynTec.
- D. There must be no deviations made from Carlisle's specifications or Carlisle's approved shop drawings without the **PRIOR WRITTEN APPROVAL** of Carlisle SynTec.
- E. After completion of the installation, upon request, an inspection shall be conducted by a Field Service Representative (FSR) of Carlisle SynTec to ascertain that the membrane roofing system has been installed according to Carlisle's published specifications and details applicable at the time of bid. This inspection is to determine whether a warranty shall be issued. It is not intended as a final inspection for the benefit of the owner.
- F. Provide polyisocyanurate insulation that meets PIMA Quality Mark Certified LTR value through third party verification meeting ASTM C 1289, Type II, Class 1, Grade 2.
- G. Coordination between various trades is essential to avoid unnecessary rooftop traffic over completed sections of the roof and to prevent subsequent damage to the membrane roofing system.
- H. The solar reflectance of this roofing product may decrease over time due to environmental defacement such as dirt, biological growth, ponded water, etc. The roof should be monitored at regular intervals and maintained or cleaned when necessary to assure the maximum solar reflectance.
- I. Refer to the Design Reference DR-07-20 "CRRC/LEED Information" for information. (i.e. solar emittance, solar reflectance and recycled content.)

1.04 Submittals

- A. To ensure compliance with Carlisle's minimum warranty requirements, the following projects should be forwarded to Carlisle for review prior to installation, preferably prior to bid:
 - 1. Air pressurized buildings, canopies and buildings with large openings where the total wall openings exceed 10% of the total wall area on which the openings are located (such as airport hangars, warehouses and large maintenance facilities).
 - 2. Cold storage buildings and freezer facilities.
 - 3. Adhered Roofing System over 250' in height for projects with warranties up to 15 years.
 - 4. Adhered Roofing System over 100' in height for projects with warranties greater than 15 years.
 - 5. Mechanically Fastened Roofing System projects over 100' in height regardless of warranty duration.
 - 6. Projects where the Sure-Weld membrane is expected to come in direct contact with petroleum-based products or other chemicals.
 - 7. Mechanically Fastened systems specified with a fastener length exceeding 12 inches.
- B. Along with the project submittals (shop drawings and Request for Warranty), the roofing contractor must include pullout tests when results are below the requirements identified in this specification.
- C. Shop drawings must be submitted to Carlisle by the Carlisle Authorized Roofing Applicator along with a completely executed Notice of Award (Page 1 of Carlisle's Request For Warranty form) for approval. Approved shop drawings are required for inspection of the roof and on projects where on-site technical assistance is requested.

Shop drawings must include:

1. Outline of roof and size
2. Deck type (for multiple deck types)
3. Location and type of **all** penetrations
4. Perimeter and penetration details
5. Key plan (for multiple roof areas) with roof heights indicated
6. Sheet width and number of perimeter sheets for Mechanically Fastened systems
7. Fastener type, length and maximum spacing (for membrane securement) for Reinforced Mechanically Fastened systems.

Along with the project submittals (shop drawing and Request for Warranty), the roofing contractor must include **pullout test** results when the results are below the requirements identified in, Table included in Design Reference DR-06-19 “Withdrawal Resistance Criteria”.

When field conditions necessitate modifications to originally approved shop drawings, a copy of the shop drawing out–lining all modifications must be submitted to Carlisle for revision and approval prior to inspection and warranty issuance.

D. **As-Built Projects** (roofing systems installed prior to project approval by Carlisle)

The Carlisle Authorized Applicator may supply Carlisle with an As-Built drawing for a project completed prior to Carlisle’s approval. The As-Built drawings:

1. Must conform to Carlisle’s most current published specifications and details applicable at the time of bid.
2. Must be submitted along with a completely executed Notice of Completion.
3. Must include the items identified in Paragraph 1.04.C.

NOTE: As-Built projects are not recommended for those projects referenced in Paragraph 1.04A in order to ensure Carlisle warranty requirements have been met.

E. **Notice of Completion** (Page 2 of the Carlisle Request for Warranty form)

After project completion, a Notice of Completion must be submitted to Carlisle to schedule the necessary inspection of the project prior to issuance of the Carlisle Warranty.

1.05 Warranty

- A. A Total System Warranty is available for roofing systems on commercial buildings within the United States and applies only to **products manufactured or marketed by Carlisle SynTec**. The total system is defined as membrane, flashings, adhesives, sealants and other Carlisle brand products utilized in the installation. For a complete description of these products, refer to the Part II “Products” Section in this Specification and Spec Supplement “Related Products” P-01-20.

See Tables Below for information regarding Warranted Systems and Design Criteria:

TABLE I – Minimum Membrane Thickness for Various Warranty Options Identifies minimum membrane thickness for Reinforced membranes used in adhered or mechanically fastened roofing systems.

TABLE II – Mechanically Fastened Roofing Systems – TPO Membrane Fastening Criteria - Steel/Concrete Decks Identifies fastening density, field membrane width and number perimeter sheets required for the various wind zones. The assemblies are categorized based on various building height and specific wind speed warranty coverage.

TABLE III – Mechanically Fastened Roofing Systems – TPO Membrane Fastening Criteria - Wood Decks Identifies fastening density, field membrane width and number perimeter sheets required for the various wind zones. The assemblies are categorized based on various building height and specific wind speed warranty coverage.

TABLE IV – Mechanically Fastened Roofing Systems – TPO Membrane Fastening Criteria – Up to 20 Yrs - Lightweight Insulating Concrete over Steel / Gypsum / Cementitious Wood Fiber Decks Identifies fastening density, field membrane width and number perimeter sheets required for the various wind zones. The assemblies are categorized based on various building height and specific wind speed warranty coverage.

TABLE V – Adhered Roofing Systems - Underlayment and Fastening Density for TPO Assemblies with Warranties Up to 20 Yrs Identifies required underlayments for adhered roofing systems with Warranties up to 20 year based on the various wind speed coverages available. The Table also identifies fastening density or adhesive bead spacing and required edge terminations.

TABLE VI – Adhered Roofing Systems - Underlayment and Fastening Density for TPO SAT Assemblies with Warranties Up to 20 Yrs Identifies required underlayments for adhered roofing systems with Warranties up to 20 year based on the various wind speed coverages available. The Table also identifies fastening density or adhesive bead spacing and required edge terminations.

TABLE VII – Adhered Roofing Systems - Underlayment and Fastening Density for TPO Assemblies with Warranties - 25 to 30 YR Identifies required underlayments for adhered roofing systems with Warranties from 25 to 30 year based on the various wind speed coverages available. The Table also identifies fastening density or adhesive bead spacing and required edge terminations.

TABLE VIII – Adhered Roofing Systems - Underlayment and Fastening Density for TPO SAT Assemblies with Warranties – 25 to 30 YR Identifies required underlayments for adhered roofing systems with Warranties from 25 to 30 year based on the various wind speed coverages available. The Table also identifies fastening density or adhesive bead spacing and required edge terminations.

Table I **Mechanically Fastened or Adhered Membrane Systems**
Warranty Options (9)

Warranty Duration	Sure-Weld TPO Membranes								
	Warranty Wind Speed Coverage						Minimum Membrane Thickness (2)	Additional Membrane Coverage	
	55, 72, 80 or 90 mph		100 mph		110 to 120 mph				
	Adhered	Mech. Fastened	Adhered	Mech. Fastened	Adhered	Mech. Fastened		Additional Puncture	Hail
5, 10, or 15 year	√	√	√	N/A(1)	√	N/A	Sure-Weld 45-mil OR	See Below	See Below
20 year	√(3)	√	√	N/A	√	N/A	Sure-Weld 60-mil (4)	See Below	See Below
25 year (9)	√	√	√	N/A	N/A	N/A	Sure-Weld 80-mil (5)	See Below	See Below
30 year (9)	√	√	√	N/A	N/A	N/A	Sure-Weld 80-mil (5)	See Below	See Below

Notes: N/A = Not Acceptable √= Acceptable

- (1) Contact Carlisle for specific requirements.
- (2) All "T-Joints" must be overlaid with appropriate flashing material when using 60- or 80-mil TPO.
- (3) Aqua Base 120 adhesive may be used for projects with 20 year maximum warranty and wind speed coverage up to 72 mph.
- (4) Spectro-Weld OR Sure-Weld SAT TPO 60-mil membranes may be used in lieu of Sure-Weld 60-mil membrane.
- (5) Spectro-Weld 80-mil membrane OR Sure-Weld SAT TPO 80-mil membrane can be used in lieu of Sure-Weld 80-mil membrane. Sure-Weld 80-mil TPO in Special Colors are limited to Warranties Up to 20 Year.
- (6) Not Used.
- (7) Not Used.
- (8) Not Used.
- (9) Enhancements may be required for certain flashing details. Published details must be referenced for applicable requirements.
- (10) -Not Used.
- (11) Low-VOC PVC Bonding Adhesive or CAV-GRIP PVC must be utilized.

Sure-Weld TPO Membrane

Hail

- 1" Dia. Hail Coverage requires a minimum of 60-mil TPO Adhered to cover board.
- 2" Dia. Hail Coverage requires 80-mil TPO Adhered to cover board.

Additional Design Requirement:

- Cover board (SecurShield HD, SecurShield HD Plus, SecurShield HD or StormBase Composite, DensDeck Prime, DensDeck StormX Prime or Securock – Adhered Only).

Puncture

- Minimum 80-mil TPO Adhered or Mechanically Fastened.

*Using HP-X™ Fasteners for steel decks and HD 14-10 or CD-10 for structural concrete decks.

** Structural Concrete Decks use 12" O.C. spacing utilizing HD 14-10 or CD-10. Steel Decks use 6" O.C. utilizing HP-X Fasteners. Steel Decks use 12" O.C. spacing utilizing HP-Xtra Fasteners.

**TPO Membrane Fastening Criteria (All Warranties)
for Mechanically Fastening Roofing Systems
22 GA. Steel Deck or Structural Concrete Only**

Table II

Caution: Projects with 25 or 30 year warranties an additional perimeter sheet is required beyond those listed in the table below. Projects with 25 or 30 year warranties the use of 12' wide sheets is **NOT PERMITTED**

Peak Gust Wind Speed Warranty	Max. Building Height	Min. Number of Perimeter Sheets			Field* Membrane Width	Perimeter* Sheet Width	Fastening Density* (Field & Perimeter Sheets)
		Building Distance from Coastline					
		Greater than 7 miles	3 to 7 miles	Less than 3 miles			
55 MPH	Up to 60'	1	2	3	12' or 10'	6'	12" O.C.
					8'	4'	12" O.C.
	61' to 100'	2	2	3	10'	6'	** See Note
					8'	4'	12" O.C.
72 MPH	Up to 60'	2	2	3	12' or 10'	6'	12" O.C.
					8'	4'	12" O.C.
	61' to 100'	3	4	4	10'	6'	** See Note
					8'	4'	12" O.C.
80 MPH	Up to 60'	3	3	4	10'	6'	** See Note
					8'	4'	12" O.C.
	61' to 100'	3	4	4	10'	6'	** See Note
					8'	4'	12" O.C.
90 MPH	Up to 60'	3	4	4	10'	6'	** See Note
					8'	4'	12" O.C.
	61' to 100'	4	5	5	10'	6'	** See Note
					8'	4'	12" O.C.

*Using HP-X™ Fasteners for steel decks and HD 14-10 or CD-10 for structural concrete decks.

** Structural Concrete Decks use 12" O.C. spacing utilizing HD 14-10 or CD-10. Steel Decks use 6" O.C. utilizing HP-X Fasteners. Steel Decks use 12" O.C. spacing utilizing HP-Xtra Fasteners.

**TPO Membrane Fastening Criteria
(Up to 20 Year Warranty – Up to 60' Building Height)
for Mechanically Fastening Roofing Systems
Wood (Plywood or OSB) Decks**

Table III

Wood (Plywood or OSB) Decks Peak Gust Wind Speed Warranty	Deck Type	Projected Pull-Out Values	Min. Number of Perimeter Sheets			Field Membrane Width	Perimeter Sheet Width	Fastening Density (Field & Perimeter Sheets)
			Building Distance from Coastline					
			Greater than 7 miles	3 to 7 miles	Less than 3 miles			
55 MPH	7/16" OSB	210 lbs	2	3	3	10'	5"	9" O.C.
			2	3	3	8'	5"	12" O.C.
	15/32" 3-Ply Plywood	240 lbs	2	2	3	8'	5"	12" O.C.
			15/32" 5-Ply Plywood	530 lbs	1	1	1	10'
	5/8" OSB	310 lbs			2	3	3	10'
						2	3	3
72 MPH	15/32" 3-Ply Plywood	240 lbs	2	2	3	8'	5"	12" O.C.
	15/32" 5-Ply Plywood	530 lbs	1	1	1	10'	6.5'	12" O.C.
			2	3	3	10'	5"	12" O.C.
	5/8" OSB	310 lbs	2	3	3	8'	5"	12" O.C.
						2	3	3
80 MPH	<i>Contact Carlisle for Approval and Evaluation</i>							

*Maximum duration for OSB NOT to exceed 20 Years.

**Table IV
Up to 20 Yr Warranty for Mechanically Fastening Roofing Systems
Lightweight Insulating Concrete over Steel / Gypsum / Cementitious Wood Fiber**

Peak Gust Wind Speed Warranty	Building Height 50' Max.	Min. Number of Perimeter Sheets			Field Membrane Width	Perimeter Sheet Width	Fastening Density (Field & Perimeter Sheets)
		Building Distance from Coastline					
	Deck Type	Greater than 7 miles	3 to 7 miles	Less than 3 miles			
55 MPH	Lightweight Concrete over Steel Deck	2	3 (1)	N/A	12'	6'	12" O.C.
		1	2	4	10'	6'	12" O.C.(2)
		1	2	3	8'	4'	12" O.C.(3)
	Gypsum Deck or Cementitious Wood Fiber	2 (3)	3	N/A	10'	6'	9" O.C.
		2 (3)	3	4 (4)	8'	4'	12" O.C.

N/A is Not Acceptable

- (1) Fastening Density must be secured 6" O.C.
- (2) For Buildings 51' to 75' with 10' field sheets – Fastening Density must be increased to 9" O.C.
- (3) Acceptable for Buildings up to 75' in height.
- (4) Fastening Density must be increased to 9" O.C.

Additional Design Considerations (Up to 20 YR Warranty)

1-Membrane configuration and fastening density in Table above is based on HP-X Fasteners penetrating metal pan below Lightweight Insulating Concrete and for Polymer Gyptec Fasteners engaging into Gypsum and Cementitious Fiber Decks.

2-See Design Reference DR-06-19 "Withdrawal Resistance Criteria" for more information.

Underlayment/Insulation & Required Attachment Assemblies Up to 20 YR Warranty for TPO Adhered Roofing Systems

Table V

Other Requirements are Listed in Additional Design Considerations following this Table
All Carlisle Products listed for higher wind speed coverage can also be used for Warranties for a lower speed coverage.
(i.e. 72 MPH underlayment may be used for 55 MPH underlayment)

Peak Gust Wind Speed Warranty	Minimum Membrane Underlayment*	Underlayment/Insulation Attachment		Metal Edging	
		# of Fasteners per 4' x 8' board size (1)	Adhesive Ribbon Spacing for 4' x 4' size board		
			Field		Perimeter
55 or 72 MPH	1" (20 psi) Polyisocyanurate	16 (11)	12" (6)(7)	6" (6)	Carlisle Drip Edge, SecurEdge™ 200
	1-1/2" (20 psi) Polyisocyanurate	10			
	2" (20 psi) Polyisocyanurate	8			
	1/2" SecurShield HD (3)	12			
	1/4" DensDeck Prime or 1/4" Securock	12			
80 MPH	1/2" SecurShield HD Plus (3)	8	12" (6)(7)(8)	6" (6)(8)	Carlisle Drip Edge, SecurEdge 200 (12)
	1/2" HP Recovery Board (2)	16			
	2" SecurShield HD Composite	6			
	1/2" DensDeck Prime or 1/2" Securock (2)	8			
	1-1/2" (25-psi) Polyisocyanurate	10			
2" (25 -psi) Polyisocyanurate	8				
90 MPH	1/2" DensDeck Prime or 1/2" Securock (2) or 1/2" EcoStorm VSH (2)	12	6" (10)	6" (8)(9)	Carlisle Drip Edge (4), SecurEdge 200 (4)(5) or SecurEdge 2000 or 3000.
	1/2" SecurShield HD (3) or 1-1/2" (20-psi) SecurShield Polyiso	16			
	1/2" SecurShield HD Plus (3)	12			
	2" (20-psi) SecurShield Polyiso or 2" SecurShield HD Composite	8			
	1-1/2" StormBase (OSB/Polyiso Composite) or 1/2" EcoStorm VSH (2)	8			
1-1/2" Insulfoam HD Composite	16				
100 MPH	2" (25-psi) SecurShield Polyiso (1)	16	FS	FS	Carlisle Drip Edge (4), SecurEdge 200 (4)(5) or SecurEdge 2000 or 3000.
110 MPH	1-1/2" StormBase (OSB/Polyiso Composite) or 1/2" EcoStorm VSH (2)	16	FS	FS	SecurEdge 2000 or 3000
	1/2" SecurShield HD Plus (3)				
120 MPH	5/8" DensDeck Prime or 5/8" Dens Deck StormX Prime or 5/8" Securock (2)	16	FS	FS	SecurEdge 2000 or 3000
	1-1/2" StormBase (OSB/Polyiso Composite) (1) or 1/2" EcoStorm VSH (3)	17			
	1/2" SecurShield HD Plus (3)	24			
	2" SecurShield HD Composite	16			

FS = Full Spray or Ribbons @ 4" O.C.

*For Direct Application over Wood Decks and Lightweight Cellular Concrete, Refer to Roof Deck & Substrate Criteria Table.

- (1) For Building heights between 51-100', enhance 12"-wide perimeter with 50% more fasteners and plates.
- (2) Cover boards must be installed over a min. 1" thick approved Carlisle Insulation.
- (3) 1/2" SecurShield HD limited to 90 mph. 1/2" SecurShield HD Plus limited to 120 mph.
- (4) Carlisle HP or HP-X Fasteners must be used to secure Carlisle Drip Edge or SecurEdge 200 Metal Fascia to perimeter wood nailers.
- (5) Membrane securement is required at the base of the SecurEdge 200 waterdam.
- (6) Gravel Surface BUR - Field @ 6" O.C. / Perimeter @ 4" O.C.
- (7) Steel Decks - Field & Perimeter @ 6" O.C.
- (8) Cementitious Wood Fiber - Field @ 6" O.C. / Perimeter @ 4" O.C.
- (9) Smooth BUR - Field @ 6" O.C. / Perimeter @ 4" O.C.
- (10) Gravel Surface BUR - FS
- (11) Reduced fastening (11 fasteners per 4 x 8 board) is acceptable on Reroof/No Tear off projects with a maximum roof height of 40'.
- (12) May be fastened with ring shank nails staggered 4" on center. Carlisle HP or HP-X Fasteners may also be used fastened 12" on center.

Additional Design Considerations (Up to 20 YR Warranty)

- 1 - Refer to Table I paragraph 1.05 for warranty options available with various membrane thickness.
- 2 - Building height shall not exceed 100'
- 3 - Local Wind Zone per ASCE 7 shall not exceed 130 mph*
- 3 - Acceptable decking: 22-gauge or heavier steel, structural concrete, 1-1/2" wood plank, or 15/32" plywood.

* Projects where building height exceeds 100', shall be submitted to Carlisle for review.

Underlayment/Insulation & Required Attachment Assemblies Up to 20 YR Warranty for TPO SAT Adhered Roofing Systems

Table VI

Other Requirements are Listed in Additional Design Considerations following this Table

All Carlisle Products listed for higher wind speed coverage can also be used for Warranties for a lower speed coverage. (i.e. 72 MPH underlayment may be used for 55 MPH underlayment)

Peak Gust Wind Speed Warranty	Minimum Membrane Underlayment	Insulation Attachment		Metal Edging	
		# of Fasteners per 4' x 8' board size (1)	Adhesive Ribbon Spacing for 4' x 4' size board		
			Field		Perimeter
55 or 72 MPH	1" (20 psi) Polyisocyanurate	16 (9)	12" (4)(5)	6" (4)	Carlisle Drip Edge, SecurEdge 200
	1-1/2" (20 psi) Polyisocyanurate	10			
	2" (20 psi) Polyisocyanurate	8			
	1/2" SecurShield HD (3)	12			
	1/4" DensDeck Prime or 1/4" Securock				
2" (1.25 lb/density) Insulfoam SP*					
80 MPH	1/2" DensDeck Prime or 1/2" Securock (2)	8	12" (4)(5)(6)	6" (4)(7)	Carlisle Drip Edge, SecurEdge (10)
	1/2" SecurShield HD (3)	16			
	1/2" SecurShield HD Plus (3)	8			
	2" SecurShield HD Composite	6			
	1-1/2" (25-psi) Polyisocyanurate	10	6" (4)(5)(6)	6" (4)(6)	
	2" (25 -psi) Polyisocyanurate	8			
	2" (1.25 lb/density) Insulfoam SP**	16			
1-1/2" Insulfoam HD Composite*	12	12" (8)	6" (6)(7)		
90 MPH	1/2" DensDeck Prime or 1/2" Securock (2)	12	6" (8)	6" (6)(7)	Carlisle Drip Edge (11), SecurEdge 200 (11)(12) or SecurEdge 2000 or 3000.
	1/2" SecurShield HD (3) or 1-1/2" (20-psi) SecurShield Polyiso	16			
	1/2" SecurShield HD Plus (3) or 1/2" EcoStorm VSH	12			
	1-1/2" StormBase (OSB/Polyiso Composite)	8			
	2" (20-psi) SecurShield Polyiso or 2" SecurShield HD Composite	8			
	1-1/2" Insulfoam HD Composite	16			
100 MPH	5/8" DensDeck Prime or 5/8" DensDeck StormX Prime or 5/8" Securock (2)	16	FS	FS	Carlisle Drip Edge (11), SecurEdge 200 (11)(12) or SecurEdge 2000 or 3000.
	1/2" SecurShield HD Plus (3)				
	1-1/2" StormBase (OSB/Polyiso Composite) or 1/2" EcoStorm VSH				
	2" (25-psi) SecurShield Polyiso (1)				
	2" SecurShield HD Composite				

FS = Full Spray or Ribbons @ 4" O.C.

(1) For Building heights between 51-100', enhance 12'-wide perimeter with 50% more fasteners and plates.

(2) Cover boards must be installed over a min. 1" thick approved Carlisle Insulation.

(3) 1/2" SecurShield HD limited to 90 mph, 1/2" SecurShield HD Plus limited to 120 mph.

(4) Gravel Surface BUR - Field @ 6" O.C. / Perimeter @ 4" O.C.

(5) Steel Decks - Field & Perimeter @ 6" O.C.

(6) Cementitious Wood Fiber - Field @ 6" O.C. / Perimeter @ 4" O.C.

(7) Smooth BUR - Field @ 6" O.C. / Perimeter @ 4" O.C.

(8) Gravel Surface BUR - FS

(9) Reduced fastening (11 fasteners per 4 x 8 board) is acceptable on Reroof/No Tear off projects with a maximum roof height of 40'.

(10) May be fastened with ring shank nails staggered 4" on center. Carlisle HP or HP-X Fasteners may also be used fastened 12" on center.

(11) Carlisle HP or HP-X Fasteners must be used to secure Carlisle Drip Edge or SecurEdge 200 Metal Fascia to perimeter wood nailers.

(12) Membrane securement is required at the base of the SecurEdge 200 waterdam.

*Maximum warranty available 20 year.

** Maximum warranty available 15 year.

Additional Design Considerations (Up to 20 YR Warranty)

1 - Minimum membrane thickness 60-mil TPO SAT

2 - Building height shall not exceed 100'

3 - Local Wind Zone per ASCE 7 shall not exceed 130 mph*

4 - Acceptable decking: 22-gauge or heavier steel, structural concrete, 1-1/2" wood plank, or 15/32" plywood.

5- All "T-joints" must be overlaid with appropriate flashing material or Carlisle "T-Joint" Covers.

* Projects where building height exceeds 100' or warranty wind speed exceeds 100 mph, shall be submitted to Carlisle for review.

**Underlayment/Insulation & Required Attachment Assemblies
25 YR or 30 YR Warranty for Adhered TPO Roofing Systems**

Table VII

Other Requirements are Listed in Additional Design Considerations following this Table

All Carlisle Products listed for higher wind speed coverage can also be used for Warranties for a lower speed coverage. (i.e. 72 MPH underlayment may be used for 55 MPH underlayment)

Peak Gust Wind Speed Warranty	Minimum Membrane Underlayment	Insulation Attachment		Metal Edging	
		# of Fasteners per 4' x 8' board size (1)	Adhesive Ribbon Spacing for 4' x 4' size board		
			Field		Perimeter
55 or 72 MPH	1" to 2" (25 psi) Polyisocyanurate	16	6" (3)(5)	6" (5)	Carlisle Drip Edge, SecurEdge 200
	1/2" HP Recovery Board (1)(9)				
	1/4" DensDeck Prime or 1/4" Securock				
	1/2" SecurShield HD (2)				
80 MPH	1-1/2" to 2" (25-psi) SecurShield Polyisocyanurate	20	6" (4)(5)(6)	6" (5)(6)	Carlisle Drip Edge (7), SecurEdge 200 (7)(8) or SecurEdge 2000 or 3000
	1/2" DensDeck Prime or 1/2" Securock (2)	16			
	1/2" SecurShield HD Plus (2)	20			
	1/2" SecurShield HD (2)				
90 MPH	1/2" SecurShield HD (2)	24	FS	FS	SecurEdge 2000 or 3000
	1/2" SecurShield HD Plus (2)	20			
	1/2" DensDeck Prime or 1/2" Securock (2)				
100 MPH	5/8" DensDeck Prime or 5/8" DensDeck StormX Prime or 5/8" Securock (2)	16	FS	FS	SecurEdge 2000 or 3000
	1-1/2" StormBase (OSB/Polyiso Composite) or 1/2" EcoStorm VSH (2)				
	2" SecurShield HD Composite (2)				
	1/2" SecurShield HD Plus (2)	24			

FS = Full Spray or Ribbons @ 4" O.C.

- (1) For Building heights between 51-100', enhance 12'-wide perimeter with 50% more fasteners and plates.
- (2) Hail coverage offered with substrate.
- (3) Structural Concrete - Field @ 12" O.C. / Perimeter @ 6" O.C.
- (4) 80-mph over structural concrete - Field & Perimeter @ 6" O.C.
- (5) Cementitious Wood Fiber & Wood - FS
- (6) 80-mph warranty wind speed coverage over Gypsum Decks - Adhesive Ribbon spacing shall be at 4" O.C.
- (7) Carlisle HP or HP-X Fasteners must be used to secure Carlisle I SecurEdge200 Metal Fascia to perimeter wood nailers.
- (8) Membrane securement is required at the base of the SecurEdge 200 waterdam.
- (9) 1/2" Recovery Board limited to 55 mph.

Additional Design Considerations (25 YR or 30 YR Warranty)

- 1 - Minimum membrane thickness 80-mil TPO
- 2 - Building height shall not exceed 100'
- 3 - Local Wind Zone per ASCE 7 shall not exceed 130 mph*
- 4 - Acceptable decking: 22-gauge or heavier steel, structural concrete, 1-1/2" wood plank, or 15/32" plywood.
- 5 - All "T-Joints" must be overlaid with appropriate flashing material or Carlisle "T-Joint" Covers.
- 6 - New construction or complete tear-off of existing roofing material.

*Projects where building height exceeds 100' or warranty wind speed exceeds 100 mph, shall be submitted to Carlisle for review.

**Underlayment/Insulation & Required Attachment Assemblies
25 YR or 30 YR Warranty for TPO SAT Adhered Roofing Systems**

Table VIII

Other Requirements are Listed in Additional Design Considerations following this table

All Carlisle Products listed for higher wind speed coverage can also be used for Warranties for a lower speed coverage. (i.e. 72 MPH underlayment may be used for 55 MPH underlayment)

Peak Gust Wind Speed Warranty	Minimum Membrane Underlayment	Insulation Attachment			Metal Edging
		# of Fasteners per 4' x 8' board size (1)	Adhesive Ribbon Spacing for 4' x 4' size board		
			Field	Perimeter	
55 or 72 MPH	1" to 2" (25 psi) Polyisocyanurate	16	6" (3)(5)	6" (5)	Carlisle Drip Edge, SecurEdge 200
	1/4" DensDeck Prime or 1/4" Securock				
	1/2" SecurShield HD (2)				
80 MPH	1-1/2" to 2" (25-psi) SecurShield Polyisocyanurate	20	6" (4)(5)(6)	6" (5)(6)	Carlisle Drip Edge (7), SecurEdge 200 (7)(8) or SecurEdge 2000 or 3000
	1/2" DensDeck Prime or 1/2" Securock (2)	16			
	1/2" SecurShield HD Plus (2)	20			
	1/2" SecurShield HD (2)				
90 MPH	1/2" SecurShield HD (2)	24	FS	FS	Carlisle Drip Edge (7), SecurEdge 200 (7)(8) or SecurEdge 2000 or 3000
	1/2" SecurShield HD Plus (2)	20			
	1/2" DensDeck Prime or 1/2" Securock (2)				
100 MPH	5/8" DensDeck Prime or 5/8" DensDeck StormX Prime or 5/8" Securock (2)	16	FS	FS	SecurEdge 2000 or 3000
	1-1/2" StormBase (OSB/Polyiso Composite) or 1/2" EcoStorm VSH (2)				
	2" SecurShield HD Composite (2)				
	1/2" SecurShield HD Plus (2)				

FS = Full Spray or Ribbons @ 4" O.C.

(1) For Building heights between 51-100', enhance 12'-wide perimeter with 50% more fasteners and plates.

(2) Hail coverage offered with substrate.

(3) Structural Concrete - Field @ 12" O.C. / Perimeter @ 6" O.C.

(4) 80-mph over structural concrete - Field & Perimeter @ 6" O.C.

(5) Cementitious Wood Fiber & Wood - FS

(6) 80-mph warranty wind speed coverage over Gypsum Decks – Adhesive Ribbon spacing shall be at 4" O.C.

(7) Carlisle HP or HP-X Fasteners must be used to secure Carlisle SecurEdge200 Metal Fascia to perimeter wood nailers.

(8) Membrane securement is required at the base of the SecurEdge 200 waterdam.

Additional Design Considerations (25 YR or 30 YR Warranty)

1 - Minimum membrane thickness 80-mil TPO SAT

2 - Building height shall not exceed 100'

3 - Local Wind Zone per ASCE 7 shall not exceed 130 mph*

4 - Acceptable decking: 22-gauge or heavier steel, structural concrete, 1-1/2" wood plank, or 15/32" plywood.

5 - All "T-Joints" must be overlaid with appropriate flashing material or Carlisle "T-Joint" Covers.

6 - New construction or complete tear-off of existing roofing material.

* Projects where building height exceeds 100' or warranty wind speed exceeds 100 mph, shall be submitted to Carlisle for review.

B. Access for warranty service

It shall be the owner's responsibility to expose the membrane in the event that warranty service is required when access is impaired. Such impairment includes, but is not necessarily limited to:

1. Design features, such as window washer systems, which require the installation of traffic surface units in excess of 100 pounds per unit.
2. Any equipment, ornamentation, building service units and other top surfacing materials which are not defined as part of this specification.
3. Photovoltaic and Mounting systems or other Rooftop equipment that does not provide Carlisle with reasonable access to the membrane system for purposes of warranty investigation and related repairs.
4. Severely ponded conditions.

CAUTION: APPLICATIONS SUCH AS WALKING DECKS, TERRACES, PATIOS OR AREAS SUBJECTED TO CONDITIONS NOT TYPICALLY FOUND ON ROOFING SYSTEMS WILL NOT BE ELIGIBLE FOR A MEMBRANE SYSTEM WARRANTY.

- C. The formation or presence of mold or fungi in a building is dependent upon a broad range of factors including, but not limited to, the presence of spores and nutrient sources, moisture, temperatures, climatic conditions, relative humidity, and heating/ventilating systems and their maintenance and operating capabilities. These factors are beyond the control of Carlisle and Carlisle shall not be responsible for any claims, repairs, restoration or damages relating to the presence of any irritants, contaminants, vapors, fumes, molds, fungi, bacteria, spores, mycotoxins, or the like in any building or in the air, land, or water serving the building.

1.06 Job Conditions

- A. On phased roofing, temporary closures should be provided to prevent moisture infiltration. When a temporary roof is specified, Carlisle 725-TR in conjunction with CCW-702, CCW 702 LV or CAV-GRIP III Low-VOC Adhesive/Primer may be used. Refer to Product Section Part II for additional product information and Specification Supplement G-08-20.
- B. When possible, on multiple level roofs, begin the installation on the highest level to avoid or minimize construction traffic on completed roof sections.
- C. On projects at high altitudes (6,000' and above) rapid flash-off (drying) of Adhesives will occur due to low atmospheric pressure.
- D. When roof slopes exceed 5 inches per horizontal foot, use of an Automatic Heat Welder may be more difficult. A Hand Held Hot Air Welder should be specified.
- E. Vapor Retarders
 1. Carlisle does not require a vapor retarder for the protection of the membrane; however, the following criteria should be considered by the specifier:
 - a. Use of a vapor retarder to protect insulation and reduce moisture accumulation within an insulated roofing assembly, should be investigated. Consult latest publications by ASHRAE (American Society of Heating, Refrigerating and Air-Conditioning Engineers, Inc.) and NRCA (National Roofing Contractors Association) for specific information.
 - b. In the generally temperate climate of the United States, during the winter months, water vapor flows upward from a heated, more humid interior toward a colder, drier exterior. Vapor retarders are more commonly required in northern climates than in southern regions, where downward vapor pressure may be expected and the roofing membrane itself becomes the vapor retarder.
 - c. On cold storage/freezer facilities, the perimeter and penetration details must be selected to provide an air seal and prevent outside air from infiltrating and condensing within the roofing assembly.

2. When a vapor retarder is specified, Carlisle 725TR Air and Vapor Barrier may be used. Refer to Part II “Products” for necessary information and Spec Supplement G-08-20 “Application Procedures for 725TR Air and Vapor Barrier” for product installation.
- F. Wood nailers are required for the securement of metal edgings, scuppers, and insulated pipes. Wood Nailer shall be secured per specifier recommendation or in accordance with Factory Mutual’s property Loss Prevention Data Sheet 1-49. Refer to Design Reference DR-08-11 “Wood Nailers Securement Criteria” in Carlisle Technical Manual shall be referenced.
 - G. When any of the Roofing Systems are specified on a portion of a roof, tie-ins to existing roofing membranes will be required. Depending on the type of the existing roofing system, the tie-in method will vary. Total isolation between two roofing systems or weep holes may be required to address moisture migration from one roofing system to the other. Prior to the selection of any tie-in detail, ensure the selected detail will not restrict drainage.
 - H. On new construction projects, located in colder climates, special consideration should be given to construction practices and the possible migration of hot, humid air and moisture generated during construction. Refer to Paragraph 1.02 I and Design Reference DR-01-21 “Construction Generated Moisture”.

1.07 Product, Delivery, Storage and Handling

- A. Deliver materials to the job site in the original, unopened containers.
- B. When loading materials onto the roof, the Carlisle Authorized Roofing Applicator must comply with the requirements of the specifier/owner to prevent overloading and possible disturbance to the building structure.
- C. Job site storage temperatures in excess of 90°F (32°C) may affect shelf life of curable materials (i.e., adhesives and sealants).
- D. When the temperature is expected to fall below 40°F (4°C), outside storage boxes should be provided on the roof for temporary storage of liquid adhesives and sealants. Adhesive and sealant containers should be rotated to maintain their temperature above 40°F (4°C). Refer to Product Data Sheets for individual products for temperature restrictions.
- E. Do not store adhesive or cleaner containers with opened lids due to the loss of solvent that will occur from flash-off.
- F. Store Carlisle membrane on provided pallets in the original undisturbed plastic wrap in a cool, shaded area and cover with light-colored, breathable tarpaulins.
- G. Insulation/underlayment must be stored so that it is kept dry and is protected from the elements. Store bundles flat and upright with the bottom of the bundles elevated (2" or more) above the finished surface.
- H. Slit the insulation bundle packaging vertically down the center of the two short sides to prevent moisture accumulation within the package. Completely cover the bundle with a waterproof tarp and secure to prevent wind damage and/or displacement.

Part III – EXECUTION

Prior to commencing with the installation of any of the Sure-Weld TPO Membrane Systems refer to Paragraph 1.05 “Warranty Tables” for applicable components and proper securement method suitable for the appropriate warranty coverage.

Requirements listed in this specification are considered minimum and are intended for the sole purpose of obtaining a Carlisle Warranty. Additional requirements dictated by Regulatory Agencies, Building Insurance or Specifiers must be complied with and are considered to be beyond the scope of this specification.

3.01 General

- A. Safety Data Sheets (SDS) must be on location at all times during transportation, storage and application of materials. The applicator shall follow all safety regulations as recommended by OSHA and other agencies having jurisdiction.
- B. Subject to project conditions, it is recommended to begin the application of this roofing system at the highest point of the project area and work to the lowest point to prevent water infiltration. This will include completion of all flashings, terminations and daily seals.
- C. A proper substrate shall be provided by the building owner. The structure shall be sufficient to withstand normal construction loads and live loads.

3.02 Roof Deck/Substrate Criteria

- A. Proper decking shall be provided by the building owner. The building owner or its designated representative must ensure that the building structure is investigated by a registered engineer to assure its ability to withstand the total weight of the specified roofing system, as well as construction loads and live loads, in accordance with all applicable codes. The specifier must also designate the maximum allowable weight and location for material loading and storage on the roof.
- B. Withdrawal resistance tests are strongly suggested to determine the suitability of a roof deck. Refer to Design Reference DR-06-19 “Withdrawal Resistance Criteria” in the Carlisle Technical Manual proper procedures for conducting pullout tests.
- C. Defects in the substrate must be reported and documented to the specifier, general contractor and building owner for assessment. The Carlisle Authorized Applicator shall not proceed with installation unless defects are corrected
- D. On structural concrete decks, when a vapor retarder is not used, gaps in the deck along the perimeter and around penetrations must be sealed along with vertical joints between tilt-up panels, if present, to prevent infiltration of hot humid air and possible moisture contamination resulting from condensation. This is specifically important when adhesive is used to attach the roof insulation. (Migrating warm air through gaps left unsealed can result in condensation and weakening of the insulation bottom facer leading to possible board dislodgement.)
- E. **For all projects** (new or retrofit), the substrate must be relatively even without noticeable high spots or depressions. Accumulated water, ice or snow must be removed to prevent the absorption of moisture in the new roofing components and roofing system.
- F. Prior to the placement of membrane underlayment, clear the substrate of debris and foreign material that may be harmful to the roofing system. Gaps greater than ¼" must be filled with an appropriate material.
- G. For direct application over an acceptable roof deck/substrate or when HP Protective Mat is specified and approved by Carlisle as the membrane underlayment in accordance with the Roof Deck and Substrate Criteria Table, the substrate must be smooth, steel trowel finished (structural concrete), free of debris, protrusions, sharp edges and loose and foreign material. Cracks or voids in the substrate, greater than ¼", must be filled with an appropriate material.

- H. The following chart identifies the acceptable roof decks/substrates and the minimum underlayment requirements, Tables in Paragraph 1.05 for specific acceptable underlayment types, based on warranty duration:

Roof Deck & Substrate Criteria

TPO Membrane		Acceptable Roof Deck/Substrate
Adhered	Mechanically Fastened	NEW CONSTRUCTION
Insulation	Insulation	Steel (min. 22 gauge) (1)(2), Wood Plank (3/4" min.), or Fibrous Cement
Direct Application	Insulation	Structural Concrete (min. 3000 psi)
Direct Application (5)	Direct Application (5)	Plywood (min. 15/32" thick) or Oriented Strand Board (min. 7/16" thick)
Direct Application (10)	Direct Application	Lightweight Insulating Concrete
Adhered	Mechanically Fastened	RETROFIT / NO TEAR-OFF
Direct Application (9) (11)	Direct Application (9) (11)	Existing Smooth Surface BUR (3)(8) or Mineral Surface Cap Sheet
Insulation	Insulation	Gravel Surfaced BUR (3)(4) or Coal Tar Pitch (3)(4)(12)
Direct Application (7)(9)	Direct Application (7)(9)	Modified Bitumen (11)
Insulation	Direct Application (6)	Existing Single-Ply (11)
Complete Tear-off Required	Complete Tear-off Required	Sprayed-in-place Urethane
Adhered	Mechanically Fastened	RETROFIT / TEAR-OFF
Insulation	Insulation	Existing roof material removed (regardless of deck type)

Notes:

- (1) Local codes must be consulted regarding thermal barrier requirements.
- (2) Mechanically Fastened Systems cannot be specified on steel decks less than 22 gauge or for corrugated steel decks, regardless of gauge. Refer to the Metal Retrofit Roofing System Specification, published separately, for installation options.
- (3) Loose gravel must be removed to avoid entrapment of moisture.
- (4) Existing coal tar could drip back into the building, especially when new insulation does not provide sufficient thermal value to prevent the surface of the coal tar from softening.
- (5) Maximum Warranty Duration of 20 Years.
- (6) An approved underlayment is required over existing ballasted (ballast removed) single-ply systems and PVC roofing systems of any type.
- (7) Direct application permitted over smooth surfaced modified bitumen. To reduce the probability of cold welds, membrane shall be positioned with length of sheets parallel to modified bitumen field seams. At end laps or other locations where splices intersect modified bitumen field seams, 6" wic Sure-Weld Flashing must be heat welded over intersections.
- (8) Existing Type III or IV smooth asphalt BUR Only.
- (9) Possible staining/discoloration of the membrane may result when installing this system directly over existing smooth surfaced BUR or modified bitumen. If aesthetics are critical, an approved insulation should be specified beneath the membrane.
- (10) New approved cellular lightweight insulating concrete must have a minimum compressive strength of 200 psi. Except when the lightweight concrete is poured over slotted steel decks, pressure relief vents must be installed every 2,000 square feet. Direct application is not permitted when lightweight concrete is poured over an existing roofing material. Equilibrium moisture content after hydration/curing shall not exceed 12%.
- (11) Maximum warranty available 20 YR with 55 MPH peak gust wind speed coverage. Carlisle may be contacted for other warranty options.
- (12) If insulation is specified to be secured to an existing coal tar pitch roof with Carlisle Flexible FAST Adhesive or hot asphalt, minimum 1.5" thick Polyisocyanurate is the required minimum thickness when white membrane is specified.

- I. **On retrofit - recover projects**, cut and remove wet insulation, as identified by the specifier, and fill all voids with new insulation of type specified so it is relatively flush (+/- 1/4") with the existing surface.
1. Entrapment of water between the old and new membrane can damage and deteriorate new insulation/underlayment between the two membranes. **If a vapor retarder or air barrier is not specified**, Carlisle recommends the existing membrane be perforated to avoid potential moisture accumulation and to allow the detection of moisture to enable the building owner to take corrective action. This can be accomplished by drilling approximately 3/4" diameter holes every 100 square feet in the existing built-up roof or single-ply membrane (excluding non-reinforced PVC membrane).
 2. If total removal of existing PVC membrane is not specified, existing non-reinforced membrane may be cut into maximum 10' x 10' sections, when the new insulation or membrane underlayment is to be mechanically fastened.
 3. Regardless of the type of membrane or assembly selected, any loose flashings at the perimeter, roof drains and roof penetrations must be removed.

4. When installing this roofing system over an existing **gravel surfaced built-up roof, loose gravel must be removed**. Power brooming is recommended by Carlisle to remove the loose gravel, which may trap moisture. Any uneven areas of the substrate must be leveled to prevent insulation from bridging.
5. On retrofit projects, all existing phenolic insulation must be removed.
6. Refer to table above for other Recover/Retro-fit considerations.

J. Vapor Retarder Installation

For Carlisle's Vapor Retarder refer to Spec Supplement G-08-20 "Application Procedures for 725TR Air and Vapor Barrier". Follow the respective vapor retarder manufacturer's recommended installation procedures and the specifier's instructions for the installation of the product specified. When insulation is to be set in adhesive, verify compatibility with Carlisle when Vapor Retarder by others is specified.

K. Wood Nailers

- a. Install wood nailers in locations that have been designated by the specifier and as approved by Carlisle. Refer to Design Reference DR-08-11 "Wood Nailers and Securement Criteria" for Wood Nailer Criteria.
- b. Wood nailers are not covered by the Carlisle Warranty.

3.03 Insulation/Underlayment

A. General

1. Roof insulation thickness must be determined by the thermal value required for each project and may be subject to code approval limitations. On projects where a vapor retarder is used, the specifier must calculate insulation thickness to ensure the temperature at the vapor retarder will not fall below the dew point.
2. For new construction projects in cold climate regions, the use of vapor retarders or air barriers is strongly recommended to protect insulation from moisture generated during construction.
3. Multiple layers of insulation are recommended with all joints staggered between layers.
4. Do not install more insulation/underlayment than can be covered by membrane in the same day.
5. All insulation boards must be butted together with no gaps greater than ¼". Gaps greater than ¼" are not acceptable.
6. Restrictions:
 - a. Carlisle Roofing Systems cannot be specified in conjunction with Phenolic Insulation.
 - b. Fiberglass insulation cannot be specified even if overlaid with additional insulation or membrane underlayment.
 - c. For all Thermoplastic Roofing Assemblies, the use of insulation by others is not acceptable when a Carlisle Membrane System Warranty is specified. Carlisle insulation must be used.

3.04 Insulation Attachment

A. General

1. Prior to proceeding with insulation securement refer to Warranty Tables, Paragraph 1.05, for attachment method and appropriate fastening density required for the specific Carlisle Warranty.

B. Adhered Roofing Systems

1. **Mechanical Attachment**, insulation fastening density will vary based on insulation type, thickness, and required warranty. Warranty Tables in Paragraph 1.05 should be referenced for fastening density and the appropriate Carlisle detail may be consulted to identify acceptable fastening pattern.

- a. For code compliance, increased fastening density may be required depending upon project wind speed and wind uplift requirement. Refer to Design Reference DR-05-19 “Insulation Fastening Patterns” for fastening pattern reference.
 - b. When insulation securement is to comply with Factory Mutual (FM) approvals, follow the requirements of the specifier concerning additional securement at the roof perimeter and corners. Also refer to Design Reference DR-05-19 “Insulation Fastening Patterns” for various fastening patterns.
 - c. On Reroof/No-Tear-off projects with a maximum roof height of 40', any Carlisle Insulation (i.e., ½" SecurShield HD, HP Recovery Board, Polyisocyanurate less than 1-½" thick) may be secured at the minimum rate of 11 Fasteners per 4' x 8' board (5 Fasteners per 4' x 4' board).
 - d. When Oriented strand board (OSB) is specified for membrane underlayment, utilize Stormbase OSB/Polyiso Composite, mechanically fastened to the deck at the rate 17 fasteners for 4 x 8 board in accordance with Carlisle Details. When positioning OSB, butt edges and stagger joints of adjacent panels.
2. **Adhesive attachment**, Carlisle Urethane Adhesive Full Spray (Flexible FAST) or Bead (Flexible FAST or Olybond) may be used. When bead adhesive is specified, bead spacing will vary based on Warranty coverage, refer to Warranty Tables, Paragraph 1.05 and appropriate Carlisle Details. **CAUTION:** Apply adhesive bead so that the distance from the edge of the board does not exceed half the bead spacing (i.e. within 6" of bead spacing of 12" O.C.).
- a. **CAUTION: Do not apply urethane adhesives directly to un-weathered asphalt, (new or residual).**
 - b. **CAUTION: Especially in cold regions on tear-off projects or new construction gaps between horizontal and vertical surfaces of the roof area as well as gaps around penetrations must be sealed to prevent interior warm air from infiltrating and condensing within the roofing assembly. Condensing moisture could weaken bottom insulation facer and eventually result in dislodgement or loose boards when adhesive is used.**
 - c. On FM Global insured projects, consult FM Global's local representative concerning the use of adhesive to attach insulation to steel decks.
 - d. Check to ensure the substrate is clean, free of debris, other contaminants, and dry. Adhesive cannot be applied to a wet or a damp surface.
 - e. Apply Adhesive over the dry substrate area at the coverage rates indicated in Spec Supplement G-03-20 “Insulation Attachment with Flexible FAST Adhesive”.
 - f. Allow the adhesive to rise up approximately ¼" and develop strings prior to setting insulation boards into adhesive.

NOTE: String-time is measured by touching the adhesive with a splice wipe and looking for development of “strings” of adhesive as you pull the splice wipe out of the adhesive. With Flexible FAST Adhesive, string time is generally around 1-½ – 2 minutes after application at room temperature.
 - g. **Walk the boards into the adhesive and roll using the 30" wide, 150 pound segmented steel roller** to ensure full embedment. Optimal set up time should be approximately 5 to 7 minutes.

CAUTION: Walking on the boards immediately after placement in adhesive can cause slippage/movement until the adhesive has started to set up.

On roofs with a slope greater than ½" in 12", begin adhering insulation at the low point and work upward to avoid slippage.

A person should be designated to walk/roll-in all boards and trim/slit or apply weight as needed to ensure adequate securement.

- a. Refer to Spec Supplement G-02-20 "Flexible FAST Adhesive Equipment and Set-Up Requirements" and G-03-20 "Insulation Attachment with Flexible FAST Adhesive" for application procedures and coverage rates.
3. **Alternate attachment method**, the specifier may select an alternate insulation attachment that incorporates a solid mopping of the insulation with hot asphalt (ASTM D312, Type III or IV). If the attachment method is to be covered by the Carlisle Warranty, Carlisle must be contacted for specific requirements. Upon review and acceptance by Carlisle, the maximum warranty coverage available is limited to 15 Year with maximum Peak Gust Wind Speed Coverage of 55 mph, for other warranties contact Carlisle.
 - a. Extruded or Expanded Polystyrene insulation are not acceptable when this alternate attachment method is specified.
 - b. The existing gravel surfaced built-up roof must be scraped to remove all loose gravel. Large blisters that may prevent continuous embedment of insulation must be repaired. The surface of the substrate must also be dry and clear of foreign material.
 - c. On coal tar pitch, when deemed compatible by the specifier, minimum 1.5" Polyisocyanurate is the required membrane underlayment when using darker heat weldable membranes (tan or gray). If Sure-Weld white membrane is used, minimum 1" thick Polyisocyanurate is required.
 - d. For successful attachment, proper asphalt temperatures must be maintained and the specifier's requirements concerning the installation of a base sheet (where required) and quantity of hot asphalt must be followed.
 - e. The maximum insulation board size shall not exceed 4' X 4'. Trim insulation boards around crickets and saddles to ensure continuous embedment.
 - f. Care must be exercised to prevent contamination of the top surface of the insulation. Asphalt oozing through insulation joints must be wiped from the surface. Contact with fresh asphalt can result in discoloration of the Sure-Weld membrane.
 - g. A grid shall be installed subdividing the roof in individual sections of 2400 square feet. Required for warranties up to 10 year with wind speed coverage up to 55mph.
 - h. The wood nailers are installed relatively flush with the insulation surface and the membrane is to be fastened with seam fastening plates and Carlisle HP or HP-X fasteners on 12" o.c. For wood nailer installation, refer to Design Reference DR-08-11 "Wood Nailers and Securement Criteria".

C. Mechanically Fastened Roofing Systems

1. **Carlisle Fasteners and Fastening Plates are required for insulation securement.** Refer to Insulation Fastening Criteria Table in Paragraph 2.05, for appropriate fastener and deck penetration. The fastener can be used with either a 2" diameter Seam Fastening Plate or 2-³/₈" diameter Pirahna/Pirahna Xtra Plates OR 3" diameter Insulation Fastening plate.
2. **Any Carlisle approved insulation or cover board** shall be mechanically fastened to the roof deck at the minimum rate of **1.25 fasteners and plates per every 8 square feet** (5 fasteners in a 4 x 8 board) for minimum 1-¹/₂" thick insulation and coverboards. Insulation greater than 1-¹/₂" thick requires the use of 8 fasteners and plates in a 4' x 8' board (1 per 4 square feet).

CAUTION: Carlisle Polyisocyanurate Insulation with a thickness less than 1.5" installed over an existing roofing membrane without a tear-off must be mechanically fastened to the roof deck with a minimum of **1 fastener and plate for every 4 square feet** or less of insulation.

3. Use of DensDeck, DensDeck Prime and DensDeck StormX Prime should be limited to assemblies with slopes greater than 2" per foot to ensure compliance with external fire codes.

3.05 Membrane Placement and Securement

A. General

1. **Ensure** that water does not flow beneath any completed sections of the membrane system by completing all flashings, terminations and daily seals by the end of each workday.
2. **Sweep** all loose debris from the substrate.
3. If aesthetics are of concern, protection should be specified to avoid discoloration of the white membrane surface resulting from adhesive residue or excess foot traffic.
4. In addition to the primary membrane securement (Bonding for Adhered and Fastening for Mechanically Fastened Assemblies), additional membrane securement is required at the perimeter of each roof level, roof section, curb, skylight, interior wall, penthouse, etc., at any inside angle change where slope or combined slopes exceed 2" in one horizontal foot, and at other penetrations in accordance with the applicable Carlisle details. Refer to Paragraph F for additional membrane securement.

B. Membrane Placement

Maximum 12' wide Sure-Weld is fully adhered or mechanically fastened to an approved insulation or substrate.

1. **Position** Sure-Weld membrane over the acceptable substrate. For a mechanically fastened assembly, ensure proper number of perimeter sheets are positioned along the perimeter of the roof as outlined in Paragraph 1.05 "Warranty Tables".
2. **Position** field sheets perpendicular to the steel deck flutes in Mechanically Fastened Applications.
3. **Place** adjoining membrane sheets in the same manner, overlapping edges appropriately to provide for the minimum overlap width. It is recommended all overlaps be shingled to avoid bucking of water.

C. Membrane Securement / Bonding - Adhered Roofing System

1. **Adhere** Sure-Weld membrane to an acceptable substrate with Carlisle Bonding Adhesive. CAV-GRIP III Low-VOC aerosol adhesive may be utilized with Sure-Weld TPO membranes. Comply with Labels, Safety Data Sheet (SDS) and Product Data Sheets for installation procedures and use. Adhesive must be applied to both the membrane and the surface to which it is being bonded.
2. On projects at high altitudes (6,000' and above), rapid flash-off (drying) of Bonding Adhesive and Primers will occur due to low atmospheric pressure.
3. **Fold** membrane sheet back so half the underside is exposed. Sheet fold should be smooth without wrinkles or buckles.
4. **Stir** Bonding Adhesive thoroughly scraping the sides and the bottom of the can (minimum 5 minutes stirring is recommended). Bonding surfaces must be dry and clean.
5. **Apply** Bonding Adhesive to the exposed underside of the membrane and the corresponding substrate area. Do not apply Bonding Adhesive along the splice edge of the membrane to be heat welded over adjoining sheet.

When using **Sure-Weld Bonding Adhesive**, a coverage rate of approximately 120 square feet per gallon per one surface (membrane or substrate) or approximately 60 square feet per gallon per finished surface (includes coverage on both membrane and substrate) shall be achieved. **Apply** adhesive evenly, without globs or puddles with a plastic core, medium nap paint roller to achieve continuous coating of both surfaces. A 9-inch roller will easily fit into the 5-gallon containers.

A mechanical roller dispenser can be used to apply Bonding Adhesive when the continuous coating and coverage rate noted above are maintained. Backrolling is required.

CAUTION: Due to solvent flash-off, condensation may form on freshly applied Bonding Adhesive when the ambient temperature is near the dew point. If condensation develops, possible surface contamination may occur, and the application of Bonding Adhesive must be discontinued. Allow the surface to dry and apply a thin freshener coat at the coverage rate which is approximately half the coverage rate stated above to the previously coated surface when conditions allow for continuing.

NOTE: When Aqua Base 120 is specified refer to Spec Supplement G-10-18 "Aqua Base 120 Bonding Adhesive" for application methods and warranty requirements.

6. **Allow** adhesive to flash-off until it does not string but remains tacky to a dry finger touch.
CAUTION: Care must be exercised to ensure proper drying. Avoid thin areas of adhesive because over drying can occur and proper adhesion may not be achieved.
7. **Roll** the coated membrane into the coated substrate while avoiding wrinkles.
8. **Brush** down the bonded section of the membrane sheet immediately after rolling the membrane into the adhesive with a soft bristle push broom to achieve maximum contact.
9. **Fold** back the unbonded half of the sheet and repeat the bonding procedures. **Apply** Bonding Adhesive to the remaining exposed underside of membrane and adjacent substrate and complete this section as described above.
10. **Install** adjoining membrane sheets in the same manner, overlapping edges a minimum of 2 inches to provide for a minimum 1-½ inch heat weld. It is recommended that all splices be shingled to avoid bucking of water.

CAUTION: If aesthetics are of concern, protect completed sections of the roof so Bonding Adhesive will not discolor the membrane surface. Do not place Bonding Adhesive containers or their lids directly on the surface of the Sure-Weld membrane, to avoid rust stains.

D. Membrane Securement / Fastening - Mechanically Fastened Roofing Systems

1. Sure-Weld TPO membranes shall be mechanically attached to the structural deck with specified Carlisle Fasteners and designated Plates, for fastening densities and numbers of perimeter sheets refer to Warranty Tables, Paragraph 1.05.
2. Membrane Fastening Selection Table:

Membrane Fastener Selection

Deck Type	Carlisle Fasteners*	Carlisle Plate	Min. Penetration
Steel or Lightweight Insulating Concrete over Steel	HP-X	Piranha Plates	3/4"
	HP-Xtra	Piranha-Xtra Plates	
Structural Concrete, rated 3,000 psi or greater	CD-10	Piranha Plates	1"
	HD 14-10	Piranha Plates	
Wood Plank, min. 15/32" thick Plywood or min. 7/16" OSB	HP-X	Piranha Plates	Min. 1"
	HP-Xtra	Piranha-Xtra Plates	
Cementitious Wood Fiber Gypsum	Polymer Gyptec	Gyptec Plates – 2" Dia.	1-1/2"
	Polymer Gyptec	Gyptec Plates – 2" Dia.	1-1/2"

Refer to Warranty Tables in Paragraph 1.05 for fastening densities and number of perimeter sheets.
*Determine proper fastener length for deck penetration, refer to Table 2.05B.

3. On steel decks, membrane shall be positioned with seams perpendicular to the steel deck flutes. This allows the external forces on the roof assembly to be distributed between multiple steel deck panels. Refer to Design Reference DR-06-19 "Withdrawal Resistance Criteria" in the Carlisle Technical Manual.
4. Perimeter Sheets

The number of perimeter sheets and fastener spacing is dependent on the building height, wind zone location and warranty duration as outlined in Warranty Tables in Paragraph 1.05.

The roof perimeter is defined as all edges of each roof section (i.e., parapets, building expansion joints at adjoining walls, penthouse walls, etc.). When multi-level roofs meet at a common wall, the adjacent edge of the upper roof is treated as a roof perimeter if the difference in height is greater than 10'. Perimeter sheets are not required at the base of the wall at the lower level.

NOTE: Expansion joints, control joints and fire walls in the field of the roof or roof ridges with slopes less than 3' to the horizontal foot are not considered as part of the roof perimeter.

For Sure-Weld membranes, perimeter sheets can be formed by using individual 4' to 6' wide sheets or by sub-dividing 8' or 10' wide field sheet using 10" wide Pressure-Sensitive RUSS strip or row of seam fastening plates as described below.

a. **Individual perimeter sheets** (TPO – 4', 5' or 6' wide)

Position membrane along the perimeter of the roof over the acceptable insulation/underlayment. The perimeter membrane width from line of securement to line of securement should be approximately 3'-6" to 4'-0" wide.

b. **RUSS - Reinforced Universal Securement Strip Method (Sure-Weld Membrane Only)**

- i. When **field sheets are positioned parallel to a roof perimeter, 10" wide Sure-Weld Pressure-Sensitive RUSS** (with 3" wide tape each side) shall be placed approximately down the center of the 8'-0", 10'-0" or 12'-0" wide Sure-Weld TPO field membrane sheets. When a RUSS divides a field sheet in half, two perimeter sheets are created.
- ii. When field membrane sheets **extend perpendicular to the edge of the roof**, position the **10" wide Sure-Weld Pressure-Sensitive RUSS** beneath the membrane along the center of each field sheet extending a distance equal to 0.4 times the building height to create perimeter sheets.

CAUTION: 6" wide Sure-Weld Pressure-Sensitive RUSS is only available with 3" wide SecurTAPE on one side and therefore cannot be used to form perimeter sheets.

c. **Fastening Plates Method**

In lieu of the RUSS securement method, position a row of seam fastening plates in the locations identified in Paragraph 4.b.1 and 4.b.2, secure plates with appropriate fastener and overlay plates with 6" wide Pressure-Sensitive Sure-Weld Cover Strip (TPO Only) overlay the plates as follows:

- i. Sure-Weld Installation – Warranties Up to 20 Years - 6" wide Pressure Sensitive Sure-Weld Cover Strip or 6" wide Sure-Weld membrane centered over the plates and heat welded to the field membrane. Seal cut edges of TPO overlay with TPO Cut-Edge Sealant to seal any exposed scrim.
- ii. Projects with Warranties greater than 20 Years, center 6" wide section of TPO membrane (equal thickness to the deck membrane) over the plates and heat weld the field sheets. All cut edges of TPO overlay must be sealed with TPO Cut-Edge Sealant to seal any exposed scrim.

NOTE: Perimeter sheets can also be formed by positioning Rhinobond plates placed along the center of a field membrane (if heat induction welder is available on job-site). Refer to "Attachment I" for additional information.

d. **Building with Special Conditions:**

Air pressurized buildings, canopies and buildings with large openings where the total wall openings exceed 10% of the total wall area on which the openings are located (such as airport hangars, warehouses and large maintenance facilities) will typically require additional perimeter membrane securement, an increased fastening density or other enhancement.

e. **Buildings with large openings**

When any wall contains major openings with a combined area which exceeds 10% of the total wall area on which the openings are located, four (4) perimeter sheets (centered over the opening) must be specified as shown.

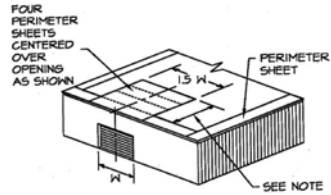

As an option to the above perimeter securement, an adhered membrane section may be used in lieu of the mechanically fastened membrane at large openings in accordance with the Carlisle Specification for the Sure-Weld Adhered Roofing System.

NOTE: Depth of perimeter area, noted above, shall not be less than 2.5 times the width of the opening.

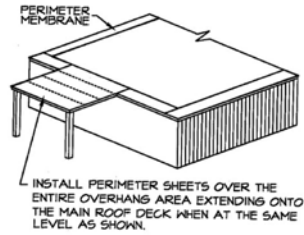

f. **Buildings with overhangs**

The membrane must be specified with perimeter sheets installed over the entire overhang area extending onto the main roof deck when at the same level.

As an option, an adhered membrane section may be used in lieu of the mechanically fastened membrane at building overhangs in accordance with the Carlisle Specification for the Sure-Weld Adhered Roofing System.

5. **Field Membrane**

- a. **Position** adjoining field membrane sheets to allow an approximate overlap of 5-½" at those locations where Fastening Plates are located (along the length of the membrane); at the same time overlap end roll sections (the width of the membrane) a minimum of 2".
- b. **Secure the membrane** at the approved fastening density with the required Carlisle Fastener and Fastening Plates.
- c. For installation of membrane with fullness, tighten the sheet between fasteners as follows:
 - i. Unroll sheets and position.
 - ii. Place a fastener and plate in one end of the sheet on the appropriate fastener mark. Go to the opposite end of the sheet, pull it tight and place a fastener and plate at the appropriate mark. Place the remaining fasteners into the sheet.
 - iii. Proceed to weld the sheet in place and continue across the roof.

6. **Prevention of membrane distortion during windy conditions:**

- a. Unroll sheet approximately 5' and position edge of membrane with overlap line on adjacent sheet.
- b. Install fasteners along the 5' exposed edge.
- c. While the 5' of exposed membrane is being fastened, begin welding the overlapped edge using the Automatic Heat Welder.
- d. As sheet is being welded and fastened concurrently, unroll membrane. Unroll only enough membrane to stay a few feet ahead of welding and fastening process. This reduces amount of unsecured membrane to be distorted by wind.
- e. Continue this process for each adjoining sheet.

E. **SAT (Self-Adhering Technology) – Self-Adhered Roofing System (membrane bonding)**

10' wide Sure-Weld SAT is fully adhered to an approved insulation or substrate with Factory Applied Pressure-Sensitive Adhesive.

1. **Position** Sure-Weld SAT membrane over the acceptable substrate.
2. **Fold** membrane sheet back so half the underside is exposed.
3. **Remove** the release liner on one half of the sheet starting from the split in the liner at the middle of the sheet. The liner should be removed at an angle to reduce risk of splitting or tearing.
4. **Roll** the membrane onto the substrate while avoiding wrinkles. To achieve the best adhesion, the membrane should be rolled onto the substrate at an angle with 30" wide, 150 lb weighted segmented steel roller. When applying the Carlisle Sure-Weld SAT TPO membrane it is recommended to maintain a large curve on the leading edge of the membrane. This will help eliminate creases and bubbles that cannot be removed after the sheet is in place.
5. **Fold** back the remaining half of the sheet and repeat the above process.

F. **Additional Membrane Securement**

1. Securement must be provided at the perimeter of each roof level, roof section, expansion joint, curb, skylight, interior wall, penthouse, etc., at any inside angle change where slope exceeds 2 inches to one horizontal foot, and at all penetrations as identified on the Carlisle details.
2. Securement may be achieved as follows:
 - a. On Mechanically Fastened Roofing Systems, Carlisle's Piranha Fastening Plates are used to secure the membrane with the appropriate Carlisle Fastener at the base of walls and penetrations and flashed as shown on the applicable Carlisle detail (excluding OSB, cementitious wood fiber and gypsum decks where the required Carlisle Fastener is installed with the associated 2" diameter plate). On **Adhered Roofing Systems**, Carlisle standard 2" diameter Seam Fastening Plates may be used in lieu of Piranha Plates.
 - b. Securement of the membrane shall be a maximum of 12 inches on center. Fasteners shall be positioned 6 inches minimum to 9 inches maximum from the inside or outside corner.
 - c. On Mechanically Fastened assemblies, additional membrane securement is required around pipes and sealant pockets as shown on the applicable detail. The plates must be positioned a maximum of 12" away from the penetration, spaced a maximum of 12" on center and flashed in accordance with the applicable Carlisle Detail.
 - d. After securing the membrane, flash in accordance with the appropriate detail.

3.06 Heat Welding Procedures

A. **General**

1. APEEL Protective Film should be removed from within areas that are to be heat-welded together. In areas that do not require heat welding, the APEEL Protective Film can be left in place for up to 90 days.
2. Heat weld the Sure-Weld membrane sheets using the Automatic Heat Welder or Hot Air Hand Welder and silicone roller.
3. When roof slope exceeds 5" per horizontal foot, use of the Automatic Heat Welding Machine may become more difficult; use of the Hand Held Hot Air Welder is recommended.
4. **Check the surfaces** of the membrane to be heat welded to ensure they are properly prepared.

The surfaces to be heat welded must be clean. Membrane overlaps that become contaminated with field dirt must be cleaned with Weathered Membrane Cleaner. No residual dirt or contaminants should be evident.

B. Automatic and/or Hand Held Heat Welder Equipment

1. Refer to **Supplemental Document T-01-18 “Heat Welding Equipment”** for:
 - a. Temperature Settings.
 - b. Equipment Set-up.
 - c. Additional Information.

C. Membrane Welding

1. Prepare the Automatic Heat Welder and allow it to warm for approximately 5 to 10 minutes to reach operating temperature.
2. Position the Automatic Heat Welder properly prior to seaming with the guide handle pointing in the same direction the machine will move along the seam.
3. Lift the overlapping membrane sheet and insert the blower nozzle of the Automatic Heat Welder between the overlap. Machine will begin moving along the seam immediately.
4. Weight plates provided on Automatic Welders must be utilized.
5. Proceed along the seam ensuring that the small guide wheel in front of the machine aligns with the edge of the top membrane sheet. Guide the machine from the front only.

CAUTION: Ensure the power cord has plenty of slack to prevent dragging the machine off course (which could result from a tightly stretched cord).

6. At all splice intersections, roll the seam with a silicone roller to ensure a continuous heat welded seam (the membrane should be creased into any membrane step-off with the edge of the silicone roller). A false weld may result due to surface irregularities created by multiple thicknesses of Sure-Weld membrane sheets.

When using **60-mil or 80-mil** Sure-Weld, a **TPO “T”-Joint Cover** must be applied over all “T” joint splice intersections.

7. To remove the Automatic Heat Welder from the finished splice, disengage and pull the nozzle from the seam area, the machine will stop automatically.
8. Mark the end of the heat welded seam with a water-soluble marker for easy identification. A Hand Held Welder will be necessary to complete the weld in the area between where the Automatic Heat Welder is stopped and restarted.
9. Perform a test weld, at least, at the start of work each morning and afternoon. Test welds should be made if any changes in substrate or weather conditions occur.

D. Preventing Membrane Creeping During Welding

1. The operator of automatic welding equipment must apply foot pressure to the membrane, keeping the membrane tight under the welder. Refer to Supplemental Document T-01-18 “Heat Welding Equipment” for additional information.

E. Test Cuts

1. Perform a test weld at least at the start of work each morning and afternoon. Refer to **Supplemental Document T-01-18 “Heat Welding Equipment”** for additional information.

F. Seam Probing

1. A cotter pin puller Carlisle TPO Seam Probe is recommended to probe all heat-welded seams. Probing seams must be done once heat welds have thoroughly cooled. Refer to **Supplemental Document T-01-18 “Heat Welding Equipment”** for additional information.

G. **Seam Sealing**

1. Apply **Cut-edge Sealant** on all cut edges of the reinforced Sure-Weld membrane (where the scrim reinforcement is exposed) **after seam probing** is completed. When a 1/8" diameter bead of TPO Cut-Edge Sealant is applied, approximately 225 – 275 linear feet of coverage per squeeze bottle can be achieved.
 - a. Cut-Edge Sealant is not required on vertical Sure-Weld splices.

3.07 Welding Problems/Repairs

- A. A Hand Held Hot Air Welder and a 2" wide silicone roller must be used when repairing the Sure-Weld membrane. When the **entire** heat welded **seam** is to be **overlaid**, an **Automatic Heat Welder** may be used.
- B. Prior to proceeding with any repair procedure, the area to be repaired must be cleaned with Weathered Membrane Cleaner. The membrane can typically be repaired with standard cleaning methods. In cases where the standard cleaning method is not sufficient, the following procedures must be used.
 1. Scrub the area to be welded with a "Scotch Brite" Pad and Weathered Membrane Cleaner.
 2. Clean all residue from the area to be welded with a Splice Wipe or a clean natural fiber (cotton) rag.
 3. Weld the new membrane to the cleaned area using standard welding procedures.
- C. Clean all residue from the area to be welded with a Splice Wipe or clean natural fiber (cotton) rag.
- D. Weld the new membrane to the cleaned area using standard welding procedures.
- E. Voids in welded seams can be repaired using a Hand Held Hot Air Welder and a silicone roller. Depending on conditions, a splice overlay may be required.
- F. Position the hand held welder facing into void so hot air is forced between overlapping membranes. Roll the top membrane surface using positive pressure toward the outer edge until the heated membrane surfaces are fused.
- G. Exposed scrim-reinforcement (resulting from scorching surface of membrane) and test weld areas must be repaired by overlaying the damaged area with a separate piece of Sure-Weld reinforced membrane with rounded corners. The overlay must extend a minimum of 2 inches past the area to be repaired.
- H. **Probe** all edges of the overlay once cooled to ensure a proper weld has been achieved.
- I. **Seal** all cut edges of Sure-Weld Reinforced membrane with TPO Cut-Edge Sealant.

NOTE: The same overlay repair procedures may be used for punctures in the Sure-Weld membrane.

Mechanically Fastened and Adhered Roofing Systems

JULY 2023

Part I – GENERAL

1.01 Description

A. Mechanically Fastened Systems (Sure-Flex)

1. The **Sure-Flex Mechanically Fastened Roofing System** incorporates 50, 60 or 80-mil Polyester Reinforced Sure-Flex Polyvinyl Chloride (PVC) membrane (white, gray, light gray, slate gray and tan) or Polyester Reinforced Sure-Flex KEE HP Polyvinyl Chloride (PVC) Membrane (white, gray, light gray or tan). Either membrane is available in 10' wide field sheets and 5' perimeter sheets. Standard Polyester Reinforced membrane is also available in 81" wide field sheets and 40.5" perimeter sheets. Sure-Flex sheets are available in rolls in 75' or 100' rolls. All sheets are mechanically fastened over an approved insulation/underlayment to an acceptable roof deck with the appropriate Carlisle Fasteners and Fastening Plates. Adjoining sheets of Sure-Flex membrane are overlapped and joined together with a minimum 1-½" wide heat weld. Membrane fastening requirements are outlined in Warranty Tables in Paragraph 1.05 of this Specification.

NOTE: Either Roofing System may be specified using over an existing standing seam, flat seam or corrugated metal roof (mechanically fastened systems incorporate membrane securement into the structural purlins). **Refer to the Metal Retrofit Roofing System Specification**, published separately, for applicable requirements.

NOTE: Either Roofing System may be specified over an existing standing seam, flat seam or corrugated metal roof (mechanically fastened systems incorporate membrane securement into the structural purlins). **Refer to the Metal Retrofit Roofing System Specification**, published separately, for applicable requirements.

B. Adhered Roofing Systems (Sure-Flex)

1. The **Sure-Flex Adhered Roofing System** incorporates maximum 10' wide, 50-mil, 60-mil or 80-mil thick Polyester or Fiberglass reinforced Sure-Flex Polyvinyl Chloride (PVC) membrane (white, gray, light gray, slate gray and tan). Carlisle Insulation is mechanically fastened to the roof deck or secured with an approved adhesive and the membrane is fully adhered to the substrate with Sure-Flex Low-VOC Bonding Adhesive, CAV-GRIP PVC aerosol contact adhesive or HydroBond Water-Based Adhesive. Adjoining sheets of membrane are overlapped and joined together with a minimum 1-½" wide heat weld.

A KEE HP enhanced (white, gray, light gray, and tan) Sure-Flex PVC membrane with Polyester Reinforcement is available in 5' and 10' width.

Polyester Reinforced membrane is available in widths of 40.5", 5', 81" and 10' wide (white, gray, light gray, slate gray and tan).

Fiberglass Reinforced membrane is available in widths of 10' (white, gray, light gray and tan).

1.02 General Design Considerations

Various Warranty Tables have been included in Paragraph 1.05 citing various requirements by which specific warranty coverage can be obtained. Appropriate Warranty Table should be referenced to ensure proper warranty coverage.

- A. The maximum roof slope for Mechanically Fastened Roofing Systems is 18" in one horizontal foot. There are no maximum slope restrictions for the application of the Adhered Roofing System.

- B. The mechanically fastened roofing system is **not acceptable** for installations on steel decks lighter than 22 gauge unless the steel deck is used in conjunction with lightweight concrete and a minimum of 360 pounds pullout per fastener is achieved with HP-X Fasteners into the steel deck below. An Adhered Roofing System may be specified or refer to the Metal Retrofit Roofing System Specification, published separately for other roofing options.
- C. Certain petroleum based products, chemicals, and waste products may not be compatible with this roofing system. Contact Carlisle for verification of compatibility and recommendations concerning an acceptable roofing assembly.
- D. Metal-Edge Systems and Copings should be designed in compliance with Section 1504.5 of the International Building Code and shall be tested in accordance with ANSI/SPRI ES-1.
- E. Concentrated loads from rooftop equipment may cause deformation of insulation/underlayment and possible damage to the membrane if proper protection is not provided. A protection course or sleepers must be specified.
- F. It is the responsibility of the specifier to review local, state and regional codes to determine their impact on the specified Carlisle Roofing System.
- G. It is the responsibility of the building owner or his/her designated representative to verify structural load limitation. In addition, a core cut may be taken to verify weight of existing components when the roofing system is to be specified on an existing facility.
- H. For information regarding CRRC (Cool Roof Rating Council) and LEED, refer to the applicable Product Data Sheets and Design Reference DR 07-20 "CRRC/LEED Information".
- I. **Construction Generated Moisture / Vapor Drive**
 - 1. On new construction projects, especially in cold climate regions, moisture generated due to the construction process could adversely impact various components within the roofing assembly if not addressed. Refer to Design Reference DR-01-21 "Construction Generated Moisture" included in the Carlisle Technical Manual.
 - 2. On structural concrete decks, when a vapor retarder is not used, gaps in the deck along the perimeter and around penetrations must be sealed along with vertical joints between tilt-up panels, if present, to prevent infiltration of hot humid air and possible moisture contamination resulting from condensation. This is specifically important when adhesive is used to attach the roof insulation.

NOTE: If left unaddressed, collected moisture could weaken insulation boards and facers resulting in a blow-off or increase the probability of mold growth.

J. **Drainage**

- 1. Drainage must be evaluated by the specifier in accordance with all applicable codes. Slopes may be provided by tapering the structure or through the use of tapered insulation; a sufficient number of roof drains should also be specified and properly located to allow for positive drainage. Significant ponding that could remain after 48 hours should be eliminated with the addition of auxiliary drains in low areas where ponding is anticipated.

Carlisle specifically disclaims responsibility for the design and selection of an adequate drainage system and drain accessories. Selection must be made by the building owner or the owner's design professional.
- 2. Small incidental areas of ponded water will not impact the performance of this roofing system; however, in accordance with industry standards, the roofing assembly **should be designed to prevent ponding** of water on the roof for prolonged periods (longer than 48 hours). Good roofing practice dictates proper drainage to prevent possible excessive live load and, in the event of a roof leak, to minimize potential interior damage to the roofing assembly and to the interior of the building.

3. **Tapered edge strips, crickets or saddles** are recommended where periodic ponding of water may occur. When the slope of the taper exceeds 2 inches to one horizontal foot, additional membrane securement at the base of the tapered edge strip will be required.
 4. Subject to code requirement, it is recommended that a minimum roof slope of $\frac{1}{8}$ " per horizontal foot be provided to serve long-term aesthetics. On new construction projects, roof drains should be positioned in areas where maximum deflection is anticipated. Slopes greater than $\frac{1}{8}$ " per foot should be considered due to possible roof deflection.
- K. **Retrofit - Recover Projects** (when the existing roofing material is left in place)
1. The removal of existing wet insulation and membrane must be specified. The specifier shall select an appropriate and compatible material as filler for voids created by removal of old insulation or membrane.
 2. Entrapment of water between old and new membrane can damage and deteriorate new insulation/underlayment between the two membranes. **If a vapor retarder or air barrier is not specified**, Carlisle recommends existing membrane be perforated to avoid potential moisture accumulation to allow for detection of moisture to enable the building owner to take corrective action. This can be accomplished by drilling approximately $\frac{3}{4}$ " diameter holes every 100 square feet in the existing built-up roof or single-ply membrane (excluding non-reinforced PVC membrane).
 3. If total removal of existing non-reinforced PVC membrane is not specified, existing membrane may be cut into maximum 10' x 10' sections, when the new insulation or membrane underlayment is to be mechanically fastened.
 4. Regardless of the type of membrane or assembly selected, any loose flashings at the perimeter, roof drains and roof penetrations must be removed.

1.03 Quality Assurance

Building codes are above and beyond the intended purpose of this specification. The **building owner, owner's representative or Specifier** should verify local codes for applicable requirements and limitations. It is the responsibility of the specifier to review local, state and regional codes to determine their impact on the specified Carlisle Roofing System.

NOTE: For code approvals achieved with the Carlisle Roofing Systems, refer to the Carlisle Code Approval Guide, DORA (Directory of Roof Assemblies), Factory Mutual (FM) Approval Guide or Underwriters Laboratories (UL) Fire Resistance or Roofing Materials and Systems Directories.

- A. When recovering or retrofitting an existing roof system, the addition of new insulation (type and thickness) may alter the fire performance characteristics of the assembly. Building owners or their designated representatives shall consult the local code enforcement agency to avoid potential code violation.
- B. Carlisle recommends the use of Carlisle supplied products for use with Sure-Flex Roofing Systems. The performance or integrity of products by others, **when selected by the specifier and accepted as compatible by Carlisle**, is not the responsibility of Carlisle and is **expressly disclaimed** by the Carlisle warranty.
- C. This roofing system must be installed by a Carlisle Authorized Roofing Applicator in compliance with drawings and specifications as approved by Carlisle SynTec.
- D. There must be no deviations made from Carlisle's specifications or Carlisle's approved shop drawings without the **PRIOR WRITTEN APPROVAL** of Carlisle SynTec.
- E. After completion of the installation, upon request, an inspection shall be conducted by a Field Service Representative (FSR) of Carlisle SynTec to ascertain that the membrane roofing system has been installed according to Carlisle's published specifications and details applicable at the time of bid. This inspection is to determine whether a warranty shall be issued. It is not intended as a final inspection for the benefit of the owner.

- F. Coordination between various trades is essential to avoid unnecessary rooftop traffic over completed sections of the roof and to prevent subsequent damage to the membrane roofing system.
- G. Provide polyisocyanurate insulation that meets PIMA Quality Mark Certified LTTR value through third party verification meeting ASTM C 1289, Type II, Class 1, Grade 2.
- H. The solar reflectance of this roofing product may decrease over time due to environmental defacement such as dirt, biological growth, ponded water, etc. The roof should be monitored at regular intervals and maintained or cleaned when necessary to assure the maximum solar reflectance.
- I. Refer to the Design Reference DR-07-20 "CRRC/LEED Information" for information. (i.e. solar emittance, solar reflectance and recycled content.)

1.04 Submittals

- A. To ensure compliance with Carlisle's minimum warranty requirements, the following projects should be forwarded to Carlisle for review prior to installation, preferably prior to bid:
 - 1. Air pressurized buildings, canopies and buildings with large openings where the total wall openings exceed 10% of the total wall area on which the openings are located (such as airport hangars, warehouses and large maintenance facilities).
 - 2. Cold storage buildings and freezer facilities.
 - 3. Adhered Roofing System over 250' in height for projects with warranties up to 15 years.
 - 4. Adhered Roofing System over 100' in height for projects with warranties greater than 15 years.
 - 5. Mechanically Fastened Roofing System projects over 100' in height regardless of warranty duration.
 - 6. Projects where the Sure-Flex membrane is expected to come in direct contact with petroleum-based products or other chemicals.
 - 7. Mechanically Fastened systems specified with a fastener length exceeding 12 inches.
- B. Along with the project submittals (shop drawings and Request for Warranty), the roofing contractor must include pullout tests when results are below the requirements identified in this specification.
- C. Shop drawings must be submitted to Carlisle by the Carlisle Authorized Roofing Applicator along with a completely executed Notice of Award (Page 1 of Carlisle's Request for Warranty form) for approval. Approved shop drawings are required for inspection of the roof and on projects where on-site technical assistance is requested.

Shop drawings must include:

- 1. Outline of roof and size
- 2. Deck type (for multiple deck types)
- 3. Location and type of **all** penetrations
- 4. Perimeter and penetration details
- 5. Key plan (for multiple roof areas) with roof heights indicated
- 6. Sheet width and number of perimeter sheets for Mechanically Fastened systems
- 7. Fastener type, length and maximum spacing (for membrane securement) for Reinforced Mechanically Fastened systems.

Along with the project submittals (shop drawing and Request for Warranty), the roofing contractor must include **pullout test** results when the results are below the requirements identified in, Table included in Design Reference DR-06-19 "Withdrawal Resistance Criteria".

When field conditions necessitate modifications to originally approved shop drawings, a copy of the shop drawing outlining all modifications must be submitted to Carlisle for revision and approval prior to inspection and warranty issuance.

D. **As-Built Projects** (roofing systems installed prior to project approval by Carlisle)

The Carlisle Authorized Applicator may supply Carlisle with an As-Built drawing for a project completed prior to Carlisle's approval. The As-Built drawings:

1. Must conform to Carlisle's most current published specifications and details applicable at the time of bid.
2. Must be submitted along with a completely executed Notice of Completion.
3. Must include the items identified in Paragraph 1.04.C.

NOTE: As-Built projects are not recommended for those projects referenced in Paragraph 1.04A in order to ensure Carlisle warranty requirements have been met.

E. **Notice of Completion** (Page 2 of the Carlisle Request for Warranty form)

After project completion, a Notice of Completion must be submitted to Carlisle to schedule the necessary inspection of the project prior to issuance of the Carlisle Warranty.

1.05 Warranty

- A. A Total System Warranty is available for roofing systems on commercial buildings within the United States and applies only to **products manufactured or marketed by Carlisle SynTec**. The total system is defined as membrane, flashings, adhesives, sealants and other Carlisle brand products utilized in the installation. For a complete description of these products, refer to the Part II "Products" Section in this Specification and Spec Supplement "Related Products" P-01-20.

See Tables Below for information regarding Warranted Systems and Design Criteria:

TABLE I – Minimum Membrane Thickness for Various Warranty Options Identifies minimum membrane thickness for Reinforced membranes used in adhered or mechanically fastened roofing systems.

TABLE II – Mechanically Fastened Roofing Systems – PVC / KEE HP PVC Membrane Fastening Criteria - Steel/Concrete Decks Identifies fastening density, field membrane width and number perimeter sheets required for the various wind zones. The assemblies are categorized based on various building height and specific wind speed warranty coverage.

TABLE III – Mechanically Fastened Roofing Systems – PVC / KEE HP PVC Membrane Fastening Criteria - Wood Decks Identifies fastening density, field membrane width and number perimeter sheets required for the various wind zones. The assemblies are categorized based on various building height and specific wind speed warranty coverage.

TABLE IV – Mechanically Fastened Roofing Systems – PVC / KEE HP PVC Membrane Fastening Criteria – Up to 20 Yrs - Lightweight Insulating Concrete over Steel / Gypsum / Cementitious Wood Fiber Decks Identifies fastening density, field membrane width and number perimeter sheets required for the various wind zones. The assemblies are categorized based on various building height and specific wind speed warranty coverage.

TABLE V – Adhered Roofing Systems - Underlayment and Fastening Density for PVC / KEE HP PVC Assemblies with Warranties Up to 20 Yrs Identifies required underlayments for adhered roofing systems with Warranties up to 20 year based on the various wind speed coverages available. The Table also identifies fastening density or adhesive bead spacing and required edge terminations.

TABLE VI – Adhered Roofing Systems - Underlayment and Fastening Density for PVC / KEE HP PVC Assemblies with Warranties - 25 to 30 YR Identifies required underlayments for adhered roofing systems with Warranties from 25 to 30 year based on the various wind speed coverages available. The Table also identifies fastening density or adhesive bead spacing and required edge terminations.

Table I

**Mechanically Fastened or Adhered Membrane Systems
Warranty Options (9)**

Warranty Duration	Sure-Flex PVC or KEE HP PVC Membranes								
	Warranty Wind Speed Coverage						Minimum Membrane Thickness (2)	Additional Membrane Coverage	
	55, 72, 80 or 90 mph		100 mph		110 to 120 mph				
	Adhered	Mech. Fastened	Adhered	Mech. Fastened	Adhered	Mech. Fastened	Additional Puncture	Hail	
5,10, or 15 year	√	√	√	N/A(1)	√	N/A	Sure-Flex 50-mil (4)	See Below	See Below
20 year	√(3)	√	√	N/A	√	N/A	Sure-Flex 60 mil (4)(5)	See Below	See Below
25 year (7)	√	√	√	N/A	N/A	N/A	Sure-Flex 80-mil (4)(6)(8)	See Below	See Below
30 year (7)	√	√	√	N/A	N/A	N/A	Sure-Flex KEE HP PVC 80-mil	See Below	See Below

Notes:

N/A = Not Acceptable

√ = Acceptable

- (1) Contact Carlisle for specific requirements.
- (2) All "T-Joints" must be overlaid with appropriate flashing material when using 80-mil PVC/KEE HP membrane.
- (3) Aqua Base 120 adhesive may be used for projects with 20 year maximum warranty and wind speed coverage up to 72 mph.
- HydroBond Adhesive (PVC Only) may be used for projects with 20 year maximum warranty and wind speed coverage up to 90 mph.
- (4) Sure-Flex FRS membrane can be used in lieu of Sure-Flex Polyester reinforced membrane for Adhered Roofing Systems Only.
- (5) Sure-Flex KEE HP PVC 50-mil membrane can be used in lieu of Sure-Flex 60-mil membrane for Warranties Up to 20 Year.
- (6) Sure-Flex KEE HP PVC 60-mil membrane can be used in lieu of Sure-Flex 80-mil membrane for Warranties Up to 25 Year.
- (7) Enhancements may be required for certain flashing details. Published details must be referenced for applicable requirements.
- (8) Sure-Flex PVC 60- or 80-mil membranes in Slate Gray are limited to Warranties Up to 20 Year.
- (9) Low-VOC PVC Bonding Adhesive must be utilized.

Sure-Flex PVC and KEE HP PVC Membrane

Hail

- 1" Dia. Hail Coverage requires a minimum of 60-mil PVC or KEE HP PVC Adhered to cover board.
- 2" Dia. Hail Coverage requires 80-mil PVC or KEE HP PVC Adhered to cover board.

Additional Design Requirement:

- Cover board (SecurShield HD, SecurShield HD Plus, SecurShield HD or StormBase Composite, DensDeck Prime, Dens Deck StormX Prime or Securock – Adhered Only).

Puncture

- Minimum 80-mil PVC with Polyester Reinforcement.

**PVC / KEE HP PVC Membrane Fastening Criteria (All Warranties)
for Mechanically Fastening Roofing Systems
22 GA. Steel Deck or Structural Concrete Only**

Table II

Caution: Projects with 25 or 30 year warranties an additional perimeter sheet is required beyond those listed in the table below.

Peak Gust Wind Speed Warranty	Max. Building Height	Min. Number of Perimeter Sheets			Field* Membrane Width	Perimeter* Sheet Width	Fastening Density* (Field & Perimeter Sheets)
		Building Distance from Coastline					
		Greater than 7 miles	3 to 7 miles	Less than 3 miles			
55 MPH	Up to 60'	1	2	3	10'	5'	12" O.C.
					81"	40.5"	12" O.C.
	61' to 100'	2	2	3	10'	5'	** See Note
					81"	40.5"	12" O.C.
72 MPH	Up to 60'	2	2	3	10'	5'	12" O.C.
					81"	40.5"	12" O.C.
	61' to 100'	3	4	4	10'	5'	** See Note
					81"	40.5"	12" O.C.
80 MPH	Up to 60'	3	3	4	10'	5'	12" O.C.
					81"	40.5"	12" O.C.
	61' to 100'	3	4	4	10'	5'	** See Note
					81"	40.5"	12" O.C.
90 MPH	Up to 60'	3	4	4	10'	5'	6" O.C.
					81"	40.5"	12" O.C.
	61' to 100'	4	5	5	10'	5'	** See Note
					81"	40.5"	12" O.C.

*Using HP-X Fasteners for steel decks and HD 14-10 or CD-10 for structural concrete decks.

** Structural Concrete Decks use 12" O.C. spacing utilizing HD 14-10 or CD-10. Steel Decks use 6" O.C. utilizing HP-X Fasteners. Steel Decks use 12" O.C. spacing utilizing HP-Xtra Fasteners.

**PVC / KEE HP PVC Membrane Fastening Criteria
(Up to 20 Year Warranty – Up to 60' Building Height)
for Mechanically Fastening Roofing Systems
Wood (Plywood or OSB) Decks**

Table III

Wood (Plywood or OSB) Decks Peak Gust Wind Speed Warranty	Deck Type	Projected Pull-Out Values	Min. Number of Perimeter Sheets			Field Membrane Width	Perimeter Sheet Width	Fastening Density (Field & Perimeter Sheets)
			Building Distance from Coastline					
			Greater than 7 miles	3 to 7 miles	Less than 3 miles			
55 MPH	7/16" OSB	210 lbs	2	3	3	10'	5"	9" O.C.
			2	3	3	8'	5"	12" O.C.
	15/32" 3-Ply Plywood	240 lbs	2	2	3	8'	5"	12" O.C.
	15/32" 5-Ply Plywood	530 lbs	1	1	1	10'	6.5'	12" O.C.
	5/8" OSB	310 lbs	2	3	3	10'	5"	12" O.C.
			2	3	3	8'	5"	12" O.C.
72 MPH	15/32" 3-Ply Plywood	240 lbs	2	2	3	8'	5"	12" O.C.
	15/32" 5-Ply Plywood	530 lbs	1	1	1	10'	6.5'	12" O.C.
	5/8" OSB	310 lbs	2	3	3	10'	5"	12" O.C.
			2	3	3	8'	5"	12" O.C.
80 MPH	<i>Contact Carlisle for Approval and Evaluation</i>							

*Maximum duration for OSB NOT to exceed 20 Years.

PVC / KEE HP PVC Membrane Fastening Criteria
Up to 20 Warranty for Mechanically Fastening Roofing Systems
Lightweight Insulating Concrete over Steel / Gypsum / Cementitious Wood Fiber

Peak Gust Wind Speed Warranty	Building Height 50' Max.	Min. Number of Perimeter Sheets			Field Membrane Width	Perimeter Sheet Width	Fastening Density (Field & Perimeter Sheets)
		Local Wind Speed					
	Deck Type	Greater than 7 miles	3 to 7 miles	Less than 3 miles			
55 MPH	Lightweight Concrete over Steel Deck	1	2	4	10'	5'	12" O.C.(1)
		2	3	4	81" (3)	40.5"	12" O.C.(2)
	Gypsum Deck or Cementitious Wood Fiber	2	3	N/A	10'	5' or 6'	9" O.C.
		2	3	4	81"	4'	12" O.C.

N/A is Not Acceptable

- (1) For Buildings 51' to 75' with 10' field sheets – Fastening Density must be increased to 9" O.C. for field and perimeter sheets.
- (2) Fasteners may be spaced at 18" O.C. in the field for buildings Up to 50' in height.
- (3) Building Height may be Up to 75' in height.

Additional Design Considerations (Up to 20 YR Warranty)

- 1- Membrane configuration and fastening density in Table above is based on HP-X Fasteners penetrating metal pan below Lightweight Insulating Concrete and for Polymer Gyptec Fasteners engaging into Gypsum and Cementitious Fiber Decks.
- 2-See Design Reference DR-06-19 "Withdrawal Resistance Criteria" for more information.

Underlayment/Insulation & Required Attachment Assemblies Up to 20 YR Warranty for Adhered PVC / KEE HP PVC Roofing

Table V

Other Requirements are Listed in Additional Design Considerations following this Table.

All Carlisle Products listed for higher wind speed coverage can also be used for Warranties for a lower speed coverage. (i.e. 72 MPH underlayment may be used for 55 MPH underlayment)

Peak Gust Wind Speed Warranty	Minimum Membrane Underlayment*	Insulation Attachment		Metal Edging	
		# of Fasteners per 4' x 8' board size (1)	Adhesive Ribbon Spacing for 4' x 4' size board		
			Field		Perimeter
55 or 72 MPH	1" (20 psi) Polyisocyanurate	16 (11)	12"(6)(7)	6"(6)	Carlisle Drip Edge, SecurEdge 200
	1-1/2" (20 psi) Polyisocyanurate	10			
	2"(20 psi) Polyisocyanurate	8			
	1/2" SecurShield HD (3)	12			
	1/4" DensDeck Prime or 1/4" Securock	12			
80 MPH	1/2" SecurShield HD Plus (3)	8	12"(6)(7)(8)	6"(6)(8)	Carlisle Drip Edge, SecurEdge 200 (12)
	1/2" HP Recovery Board (2)	16			
	2" SecurShield HD Composite	6			
	1/2" DensDeck Prime or 1/2" Securock (2)	8			
	1-1/2" (25 psi) Polyisocyanurate	10			
	2" (25 psi) Polyisocyanurate	8			
90 MPH	1/2" DensDeck Prime or 1/2" Securock (2)	12	6"(10)	6"(8)(9)	Carlisle Drip Edge (4), SecurEdge 200 (4)(5) or SecurEdge 2000 or 3000.
	1/2" SecurShield HD (3) or 1-1/2" (20 psi) SecurShield Polyiso	16			
	1/2" SecurShield HD Plus or 1/2" EcoStorm VSH (2)	12			
	2" (20 psi) SecurShield Polyiso or 2" SecurShield HD Composite	8			
	1-1/2" StormBase (OSB/Polyiso Composite)	8			
	1-1/2" Insulfoam HD Composite	16			
100 MPH	2" (25-psi) SecurShield Polyiso (1)	16	FS	FS	Carlisle Drip Edge (4), SecurEdge 200 (4)(5) or SecurEdge 2000 or 3000.
110 MPH	1-1/2" StormBase (OSB/Polyiso Composite) or 1/2" EcoStorm VSH (2)	16	FS	FS	SecurEdge 2000 or 3000
	1/2" SecurShield HD Plus (3)				
120 MPH	5/8" DensDeck Prime or 5/8" DensDeck StormX Prime or 5/8" Securock (2)	16	FS	FS	SecurEdge 2000 or 3000
	1-1/2" StormBase (OSB/Polyiso Composite) (1) or 1/2" EcoStorm VSH (2)	17			
	1/2" SecurShield HD Plus (3)	24			
	2" SecurShield HD Composite	16			

FS = Full Spray or Ribbons @ 4" O.C.

***For Direct Application over Wood Decks and Lightweight Cellular Concrete, Refer to Roof Deck & Substrate Criteria Table.**

- (1) For Building heights between 51-100', enhance 12'-wide perimeter with 50% more fasteners and plates.
- (2) Cover boards must be installed over a min. 1" thick approved Carlisle Insulation.
- (3) 1/2" SecurShield HD limited to 90 mph. 1/2" SecurShield HD Plus limited to 120 mph.
- (4) Carlisle HP or HP-X Fasteners must be used to secure Carlisle Drip Edge or SecurEdge 200 Metal Fascia to perimeter wood nailers.
- (5) Membrane securement is required at the base of the SecurEdge 200 waterproof.
- (6) Gravel Surface BUR - Field @ 6" O.C. / Perimeter @ 4" O.C.
- (7) Steel Decks - Field & Perimeter @ 6" O.C.
- (8) Cementitious Wood Fiber - Field @ 6" O.C. / Perimeter @ 4" O.C.
- (9) Smooth BUR - Field @ 6" O.C. / Perimeter @ 4" O.C.
- (10) Gravel Surface BUR – FS
- (11) Reduced fastening (11 fasteners per 4 x 8 board) is acceptable on Reroof/No Tear off projects with a maximum roof height of 40'.
- (12) May be fastened with ring shank nails staggered 4" on center. Carlisle HP or HP-X Fasteners may also be used fastened 12" on center.

Additional Design Considerations (Up to 20 YR Warranty)

- 1 - Minimum membrane thickness 60-mil PVC or 50-mil KEE HP PVC
 - 2 - Building height shall not exceed 100'
 - 3 - Local Wind Zone per ASCE 7 shall not exceed 130 mph*
 - 4 - Acceptable decking: 22-gauge or heavier steel, structural concrete, 1-1/2" wood plank, or 15/32" plywood.
 - 5 - All "T-Joints" must be overlaid with Carlisle "T-Joint" Covers.
- * Projects where building height exceeds 100', shall be submitted to Carlisle for review.

**Underlayment/Insulation & Required Attachment Assemblies
25 YR or 30 YR Warranty for Adhered PVC / KEE HP PVC Roofing Systems**

Table VI

Other Requirements are Listed in Additional Design Considerations following this Table.

All Carlisle Products listed for higher wind speed coverage can also be used for Warranties for a lower speed coverage. (i.e. 72 MPH underlayment may be used for 55 MPH underlayment)

Peak Gust Wind Speed Warranty	Minimum Membrane Underlayment	Insulation Attachment			Metal Edging
		# of Fasteners per 4' x 8' board size (1)	Adhesive Ribbon Spacing for 4' x 4' size board		
			Field	Perimeter	
55 or 72 MPH	1" to 2" (25 psi) Polyisocyanurate	16	6" (3)(5)	6" (5)	Carlisle Drip Edge, SecurEdge 200
	1/2" HP Recovery Board (1) (9)				
	1/4" DensDeck Prime or 1/4" Securock				
	1/2" SecurShield HD (2)				
80 MPH	1-1/2" to 2" (25-psi) SecurShield Polyisocyanurate	20	6" (4)(5)(6)	6" (5)(6)	Carlisle Drip Edge (7), SecurEdge 200 (7) (8) or SecurEdge 2000 or 3000
	1/2" DensDeck Prime or 1/2" Securock (2)	16			
	1/2" SecurShield HD Plus (2)	20			
	1/2" SecurShield HD (2)	20			
90 MPH	1/2" SecurShield HD (2)	24	FS	FS	SecurEdge 2000 or 3000
	1/2" SecurShield HD Plus (2)	20			
	1/2" DensDeck Prime or 1/2" Securock (2)				
100 MPH	5/8" DensDeck Prime or 5/8" Dens Deck StormX Prime or 5/8" Securock (2)	16	FS	FS	SecurEdge 2000 or 3000
	1-1/2" StormBase (OSB/Polyiso Composite) or 1/2" EcoStorm VSH (2)				
	2" SecurShield HD Composite (2)				
	1/2" SecurShield HD Plus (2)	24			

FS = Full Spray or Ribbons @ 4" O.C.

- (1) For Building heights between 51-100', enhance 12'-wide perimeter with 50% more fasteners and plates.
- (2) Hail coverage offered with substrate.
- (3) Structural Concrete - Field @ 12" O.C. / Perimeter @ 6" O.C.
- (4) 80 mph over Structural Concrete - Field & Perimeter @ 6" O.C.
- (5) Cementitious Wood Fiber & Wood – FS
- (6) 80-mph warranty wind speed coverage over Gypsum Decks – Adhesive Ribbon spacing shall be at 4" O.C.
- (7) Carlisle HP or HP-X Fasteners must be used to secure Carlisle Drip Edge or SecurEdge200 Metal Fascia to perimeter wood nailers.
- (8) Membrane securement is required at the base of the SecurEdge 200 waterdam.
- (9) 1/2" Recovery Board limited to 55 mph.

Additional Design Considerations (25 YR or 30 YR Warranty)

- 1 - Minimum membrane thickness 80-mil PVC or KEE HP PVC
- 2 - Building height shall not exceed 100'
- 3 - Local Wind Zone per ASCE 7 shall not exceed 130 mph*
- 4 - Acceptable decking: 22-gauge or heavier steel, structural concrete, 1-1/2" wood plank, or 15/32" plywood.
- 5 - All "T-joints" must be overlaid with Carlisle "T-Joint" Covers.
- 6 - New construction or complete tear-off of existing roofing material.

* Projects where building height exceeds 100' or warranty wind speed exceeds 100 mph, shall be submitted to Carlisle for review.

B. Access for warranty service

It shall be the owner's responsibility to expose the membrane in the event that warranty service is required when access is impaired. Such impairment includes, but is not necessarily limited to:

1. Design features, such as window washer systems, which require the installation of traffic surface units in excess of 100 pounds per unit.
2. Any equipment, ornamentation, building service units and other top surfacing materials which are not defined as part of this specification.
3. Photovoltaic and Mounting systems or other Rooftop equipment that does not provide Carlisle with reasonable access to the membrane system for purposes of warranty investigation and related repairs.
4. Severely ponded conditions.

CAUTION: APPLICATIONS SUCH AS WALKING DECKS, TERRACES, PATIOS OR AREAS SUBJECTED TO CONDITIONS NOT TYPICALLY FOUND ON ROOFING SYSTEMS WILL NOT BE ELIGIBLE FOR A MEMBRANE SYSTEM WARRANTY.

- C. The formation or presence of mold or fungi in a building is dependent upon a broad range of factors including, but not limited to, the presence of spores and nutrient sources, moisture, temperatures, climatic conditions, relative humidity, and heating/ventilating systems and their maintenance and operating capabilities. These factors are beyond the control of Carlisle and Carlisle shall not be responsible for any claims, repairs, restoration or damages relating to the presence of any irritants, contaminants, vapors, fumes, molds, fungi, bacteria, spores, mycotoxins, or the like in any building or in the air, land, or water serving the building.

1.06 Job Conditions

- A. On phased roofing, temporary closures should be provided to prevent moisture infiltration. When a temporary roof is specified, Carlisle 725-TR in conjunction with CCW-702, CCW 702LV or CAV-GRIP III Low-VOC Adhesive/Primer may be used. Refer to Product Section Part II for additional product information and Specification Supplement G-08-20.
- B. When possible on multiple level roofs, begin the installation on the highest level to avoid or minimize construction traffic on completed roof sections.
- C. On projects at high altitudes (6,000' and above) rapid flash-off (drying) of Adhesives will occur due to low atmospheric pressure.
- D. When roof slopes exceed 5 inches per horizontal foot, use of an Automatic Heat Welder may be more difficult. A Hand Held Hot Air Welder should be specified.
- E. Vapor Retarders
 1. Carlisle does not require a vapor retarder for the protection of the membrane; however, the following criteria should be considered by the specifier:
 - a. Use of a vapor retarder to protect insulation and reduce moisture accumulation within an insulated roofing assembly, should be investigated. Consult latest publications by ASHRAE (American Society of Heating, Refrigerating and Air-Conditioning Engineers, Inc.) and NRCA (National Roofing Contractors Association) for specific information.
 - b. In the generally temperate climate of the United States, during the winter months, water vapor flows upward from a heated, more humid interior toward a colder, drier exterior. Vapor retarders are more commonly required in northern climates than in southern regions, where downward vapor pressure may be expected and the roofing membrane itself becomes the vapor retarder.
 - c. On cold storage/freezer facilities, the perimeter and penetration details must be selected to provide an air seal and prevent outside air from infiltrating and condensing within the roofing assembly.

2. When a vapor retarder is specified, Carlisle 725TR Air and Vapor Barrier may be used. Refer to Part II "Products" for necessary information and Spec Supplement G-08-20 "Application Procedures for 725TR Air and Vapor Barrier" for product Installation.
- F. Wood nailers are required for the securement of metal edgings, scuppers, and insulated pipes. Wood nailer shall be secured per specifier recommendation or in accordance with Factory Mutual's property Loss Prevention Data Sheet 1-49. Refer to Design Reference DR-08-11 "Wood Nailers Securement Criteria" in Carlisle Technical Manual shall be referenced.
- G. When any of the Roofing Systems are specified on a portion of a roof, tie-ins to existing roofing membranes will be required. Depending on the type of the existing roofing system, the tie-in method will vary. Total isolation between two roofing systems or weep holes may be required to address moisture migration from one roofing system to the other. Prior to the selection of any tie-in detail, ensure the selected detail will not restrict drainage.
- H. On new construction projects, located in colder climates, special consideration should be given to construction practices and the possible migration of hot, humid air and moisture generated during construction. Refer to Paragraph 1.02 I and Design Reference DR-01-21 "Construction Generated Moisture".

1.07 Product, Delivery, Storage and Handling

- A. Deliver materials to the job site in the original, unopened containers.
- B. When loading materials onto the roof, the Carlisle Authorized Roofing Applicator must comply with the requirements of the specifier/owner to prevent overloading and possible disturbance to the building structure.
- C. Job site storage temperatures in excess of 90°F (32°C) may affect shelf life of curable materials (i.e., adhesives and sealants).
- D. When the temperature is expected to fall below 40°F (4°C), outside storage boxes should be provided on the roof for temporary storage of liquid adhesives and sealants. Adhesive and sealant containers should be rotated to maintain their temperature above 40°F (4°C). Refer to Product Data Sheets for individual products for temperature restrictions.
- E. Do not store adhesive or cleaner containers with opened lids due to the loss of solvent that will occur from flash-off.
- F. Store Carlisle membrane on provided pallets in the original undisturbed plastic wrap in a cool, shaded area and cover with light-colored, breathable tarpaulins.
- G. Insulation/underlayment must be stored so that it is kept dry and is protected from the elements. Store bundles flat and upright with the bottom of the bundles elevated (2" or more) above the finished surface.
- H. Slit the insulation bundle packaging vertically down the center of the two short sides to prevent moisture accumulation within the package. Completely cover the bundle with a waterproof tarp and secure to prevent wind damage and / or displacement.

Part III – EXECUTION

Prior to commencing with the installation of any of the Sure-Flex PVC Membrane Systems refer to Paragraph 1.05 “Warranty Tables” for applicable components and proper securement method suitable for the appropriate warranty coverage.

Requirements listed in this specification are considered minimum and are intended for the sole purpose of obtaining a Carlisle Warranty. Additional requirements dictated by Regulatory Agencies, Building Insurance or Specifiers must be complied with and are considered to be beyond the scope of this specification.

3.01 General

- A. Safety Data Sheets (SDS) must be on location at all times during transportation, storage and application of materials. The applicator shall follow all safety regulations as recommended by OSHA and other agencies having jurisdiction.
- B. Subject to project conditions, it is recommended to begin the application of this roofing system at the highest point of the project area and work to the lowest point to prevent water infiltration. This will include completion of all flashings, terminations and daily seals.
- C. A proper substrate shall be provided by the building owner. The structure shall be sufficient to withstand normal construction loads and live loads.

3.02 Roof Deck/Substrate Criteria

- A. Proper decking shall be provided by the building owner. The building owner or its designated representative must ensure that the building structure is investigated by a registered engineer to assure its ability to withstand the total weight of the specified roofing system, as well as construction loads and live loads, in accordance with all applicable codes. The specifier must also designate the maximum allowable weight and location for material loading and storage on the roof.
- B. Withdrawal resistance tests are strongly suggested to determine the suitability of a roof deck. Refer to Design Reference DR-06-19 “Withdrawal Resistance Criteria” in the Carlisle Technical Manual proper procedures for conducting pullout tests.
- C. Defects in the substrate must be reported and documented to the specifier, general contractor and building owner for assessment. The Carlisle Authorized Applicator shall not proceed with installation unless defects are corrected.
- D. On structural concrete decks, when a vapor retarder is not used, gaps in the deck along the perimeter and around penetrations must be sealed along with vertical joints between tilt-up panels, if present, to prevent infiltration of hot humid air and possible moisture contamination resulting from condensation. This is specifically important when adhesive is used to attach the roof insulation. (Migrating warm air through gaps left unsealed can result in condensation and weakening of the insulation bottom facer leading to possible board dislodgement.)
- E. **For all projects** (new or retrofit), the substrate must be relatively even without noticeable high spots or depressions. Accumulated water, ice or snow must be removed to prevent the absorption of moisture in the new roofing components and roofing system.
- F. Prior to the placement of membrane underlayment, clear the substrate of debris and foreign material that may be harmful to the roofing system. Gaps greater than ¼" must be filled with an appropriate material.
- G. For direct application over an acceptable roof deck/substrate or when HP Protective Mat is specified and approved by Carlisle as the membrane underlayment in accordance with the Roof Deck and Substrate Criteria Table, the substrate must be smooth, steel trowel finished (structural concrete), free of debris, protrusions, sharp edges and loose and foreign material. Cracks or voids in the substrate, greater than ¼", must be filled with an appropriate material.

- H. The following chart identifies the acceptable roof decks/substrates and the minimum underlayment requirements, Tables in Paragraph 1.05 for specific acceptable underlayment types, based on warranty duration:

Roof Deck & Substrate Criteria

Acceptable Roof Deck/Substrate	PVC / KEE HP PVC Membrane	
	Adhered	Mechanically Fastened
NEW CONSTRUCTION	Adhered	Mechanically Fastened
Steel (min. 22 gauge) (1)(2), Wood Plank (3/4" min.), or Fibrous Cement	Insulation	Insulation
Structural Concrete (min. 3000 psi)	Direct Application	Insulation
Plywood (min. 15/32" thick) or Oriented Strand Board (min. 7/16" thick)	Direct Application (5)	Direct Application (5)
Lightweight Insulating Concrete	Direct Application (10)	Insulation
RETROFIT / NO TEAR-OFF	Adhered	Mechanically Fastened
Existing Smooth Surface BUR (3)(8) or Mineral Surface Cap Sheet	Insulation	Insulation
Gravel Surfaced BUR (3)(4) or Coal Tar Pitch (3)(4)(12)	Insulation	Insulation
Modified Bitumen (11)	Insulation	Insulation
Existing Single-Ply (11)	Insulation	Direct Application (6)
Sprayed-in-place Urethane	Complete Tear-off Required	Complete Tear-off Required
RETROFIT / TEAR-OFF	Adhered	Mechanically Fastened
Existing roof material removed (regardless of deck type)	Insulation	Insulation

Notes:

- (1) Local codes must be consulted regarding thermal barrier requirements.
- (2) Mechanically Fastened Systems cannot be specified on steel decks less than 22 gauge or for corrugated steel decks, regardless of gauge. Refer to the Metal Retrofit Roofing System Specification, published separately, for installation options.
- (3) Loose gravel must be removed to avoid entrapment of moisture.
- (4) Existing coal tar could drip back into the building, especially when new insulation does not provide sufficient thermal value to prevent the surface of the coal tar from softening.
- (5) Maximum Warranty Duration of 20 Years.
- (6) An approved underlayment is required over existing ballasted (ballast removed) single-ply systems and PVC roofing systems of any type.
- (7) Direct application permitted over smooth surfaced modified bitumen. To reduce the probability of cold welds, membrane shall be positioned with length of sheets parallel to modified bitumen field seams. At end laps or other locations where splices intersect modified bitumen field seams, 6" wide Sure-Flex Flashing must be heat welded over intersections.
- (8) Existing Type III or IV smooth asphalt BUR Only.
- (9) Possible staining/discoloration of the membrane may result when installing this system directly over existing smooth surfaced BUR or modified bitumen. If aesthetics are critical, an approved insulation should be specified beneath the membrane.
- (10) New approved cellular lightweight insulating concrete must have a minimum compressive strength of 200 psi. Except when the lightweight concrete is poured over slotted steel decks, pressure relief vents must be installed every 2,000 square feet. Direct application is not permitted where lightweight concrete is poured over an existing roofing material. Equilibrium moisture content after hydration/curing shall not exceed 12%.
- (11) Maximum warranty available 20 YR with 55 MPH peak gust wind speed coverage. Carlisle may be contacted for other warranty options.
- (12) If insulation is specified to be secured to an existing coal tar pitch roof with Carlisle Flexible FAST adhesive or hot asphalt, minimum 1.5" thick Polyisocyanurate is the required minimum thickness when white membrane is specified.

- I. **On retrofit - recover projects**, cut and remove wet insulation, as identified by the specifier, and fill all voids with new insulation of type specified so it is relatively flush (+/- 1/4") with the existing surface.
1. Entrapment of water between the old and new membrane can damage and deteriorate new insulation/underlayment between the two membranes. **If a vapor retarder or air barrier is not specified**, Carlisle recommends the existing membrane be perforated to avoid potential moisture accumulation and to allow the detection of moisture to enable the building owner to take corrective action. This can be accomplished by drilling approximately 3/4" diameter holes every 100 square feet in the existing built-up roof or single-ply membrane (excluding non-reinforced PVC membrane).
 2. If total removal of existing PVC membrane is not specified, existing non-reinforced membrane may be cut into maximum 10' x 10' sections, when the new insulation or membrane underlayment is to be mechanically fastened.
 3. Regardless of the type of membrane or assembly selected, any loose flashings at the perimeter, roof drains and roof penetrations must be removed.

4. When installing this roofing system over an existing **gravel surfaced built-up roof, loose gravel must be removed**. Power brooming is recommended by Carlisle to remove the loose gravel, which may trap moisture. Any uneven areas of the substrate must be leveled to prevent insulation from bridging.
5. On retrofit projects, all existing phenolic insulation must be removed.
6. Refer to table above for other Recover/Retro-fit considerations.

J. Vapor Retarder Installation

For Carlisle's Vapor Retarder refer to Spec Supplement G-08-20 "Application Procedures for 725TR Air and Vapor Barrier". Follow the respective vapor retarder manufacturer's recommended installation procedures and the specifier's instructions for the installation of the product specified. When insulation is to be set in adhesive, verify compatibility with Carlisle when Vapor Retarder by others is specified.

K. Wood Nailers

1. Install wood nailers in locations that have been designated by the specifier and as approved by Carlisle. Refer to Design Reference DR-08-11 "Wood Nailers and Securement Criteria" for Wood Nailer Criteria.
2. Wood nailers are not covered by the Carlisle Warranty.

3.03 Insulation/Underlayment

A. General

1. Roof insulation thickness must be determined by the thermal value required for each project and may be subject to code approval limitations. On projects where a vapor retarder is used, the specifier must calculate insulation thickness to ensure the temperature at the vapor retarder will not fall below the dew point.
2. For new construction projects in cold climate regions, the use of vapor retarders or air barriers is strongly recommended to protect insulation from moisture generated during construction.
3. Multiple layers of insulation are recommended with all joints staggered between layers.
4. Do not install more insulation/underlayment than can be covered by membrane in the same day.
5. All insulation boards must be butted together with no gaps greater than ¼". Gaps greater than ¼" are not acceptable.
6. Restrictions:
 - a. Carlisle Roofing Systems cannot be specified in conjunction with Phenolic Insulation.
 - b. Fiberglass insulation cannot be specified even if overlaid with additional insulation or membrane underlayment.
 - c. For all Thermoplastic Roofing Assemblies, the use of insulation by others is not acceptable when a Carlisle Membrane System Warranty is specified. Carlisle insulation must be used.
 - d. The direct application of Sure-Flex Membrane over expanded or extruded polystyrene insulation is not permitted.

3.04 Insulation Attachment

A. General

1. Prior to proceeding with insulation securement refer to Warranty Tables, Paragraph 1.05, for attachment method and appropriate fastening density required for the specific Carlisle Warranty.

B. Adhered Roofing Systems

1. **Mechanical Attachment**, insulation fastening density will vary based on insulation type, thickness, and required warranty. Warranty Tables in Paragraph 1.05 should be referenced for fastening density and the appropriate Carlisle detail may be consulted to identify acceptable fastening pattern.
 - a. For code compliance, increased fastening density may be required depending upon project wind speed and wind uplift requirement. Refer to Design Reference DR-05-19 “Insulation Fastening Patterns” for fastening pattern reference.
 - b. When insulation securement is to comply with Factory Mutual (FM) approvals, follow the requirements of the specifier concerning additional securement at the roof perimeter and corners. Also refer to Design Reference DR-05-19 “Insulation Fastening Patterns” for various fastening patterns.
 - c. On Reroof/No Tear off projects with a maximum roof height of 40', any Carlisle Insulation (i.e., ½" SecurShield HD, HP Recovery Board, Polyisocyanurate less than 1-½" thick) may be secured at the minimum rate of 11 Fasteners per 4' x 8' board (5 Fasteners per 4' x 4' board).
 - d. When Oriented strand board (OSB) is specified for membrane underlayment, utilize Stormbase OSB/Polyiso Composite, mechanically fastened to the deck at the rate 17 fasteners for 4 x 8 board in accordance with Carlisle Details. When positioning OSB, butt edges and stagger joints of adjacent panels.
2. **Adhesive attachment**, Carlisle Urethane Adhesive Full Spray (Flexible FAST) or Bead (Flexible FAST or Olybond) may be used. When bead adhesive is specified bead spacing will vary based on Warranty coverage, refer to Warranty Tables, Paragraph 1.05 and appropriate Carlisle Details. **CAUTION:** Apply adhesive bead so that the distance from the edge of the board does not exceed half the bead spacing (i.e. within 6" of bead spacing of 12" O.C.).
 - a. **CAUTION: Do not apply urethane adhesives directly to un-weathered asphalt, (new or residual).**
 - b. **CAUTION: Especially in cold regions on tear-off projects or new construction gaps between horizontal and vertical surfaces of the roof area as well as gaps around penetrations must be sealed to prevent interior warm air from infiltrating and condensing within the roofing assembly. Condensing moisture could weaken bottom insulation facer and eventually result in dislodgement or loose boards when adhesive is used.**
 - c. On FM Global insured projects, consult FM Global's local representative concerning the use of adhesive to attach insulation to steel decks.
 - d. Check to ensure the substrate is clean, free of debris, other contaminants, and dry. Adhesive cannot be applied to a wet or a damp surface.
 - e. Apply Adhesive over the dry substrate area at the coverage rates indicated in Spec Supplement G-03-20 “Insulation Attachment with Flexible FAST Adhesive”.
 - f. Allow the adhesive to rise up approximately ¼" and develop strings prior to setting insulation boards into adhesive.

NOTE: String-time is measured by touching the adhesive with a splice wipe and looking for development of “strings” of adhesive as you pull the splice wipe out of the adhesive. With Flexible FAST Adhesive, string time is generally around 1-½ – 2 minutes after application at room temperature.
 - g. **Walk the boards into the adhesive and roll using the 30" wide, 150-pound segmented steel roller** to ensure full embedment. Optimal set up time should be approximately 5 to 7 minutes.

CAUTION: Walking on the boards immediately after placement in adhesive can cause slippage/movement until the adhesive has started to set up.

On roofs with a slope greater than 1/2" in 12", begin adhering insulation at the low point and work upward to avoid slippage.

A person should be designated to walk/roll-in all boards and trim/slit or apply weight as needed to ensure adequate securement.

- h. Refer to Spec Supplement G-02-20 "Flexible FAST Adhesive Equipment and Set-Up Requirements" and G-03-20 "Insulation Attachment with Flexible FAST Adhesive" for application procedures and coverage rates.
3. **Alternate attachment method**, the specifier may select an alternate insulation attachment that incorporates a solid mopping of the insulation with hot asphalt (ASTM D312, Type III or IV). If the attachment method is to be covered by the Carlisle Warranty, Carlisle must be contacted for specific requirements. Upon review and acceptance by Carlisle, the maximum warranty coverage available is limited to 15 Year with maximum Peak Gust Wind Speed Coverage of 55 mph, for other warranties contact Carlisle.
- a. Extruded or Expanded Polystyrene insulation are not acceptable when this alternate attachment method is specified.
 - b. The existing gravel surfaced built-up roof must be scraped to remove all loose gravel. Large blisters that may prevent continuous embedment of insulation must be repaired. The surface of the substrate must also be dry and clear of foreign material.
 - c. On coal tar pitch, when deemed compatible by the specifier, minimum 1.5" Polyisocyanurate is the required membrane underlayment when using darker heat weldable membranes (tan or gray). If Sure-Flex white membrane is used, minimum 1" thick Polyisocyanurate is required.
 - d. For successful attachment, proper asphalt temperatures must be maintained and the specifier's requirements concerning the installation of a base sheet (where required) and quantity of hot asphalt must be followed.
 - e. The maximum insulation board size shall not exceed 4' X 4'. Trim insulation boards around crickets and saddles to ensure continuous embedment.
 - f. Care must be exercised to prevent contamination of the top surface of the insulation. Asphalt oozing through insulation joints must be wiped from the surface. Contact with fresh asphalt can result in discoloration of the Sure-Flex membrane.
 - g. A grid shall be installed subdividing the roof in individual sections of 2400 square feet. Required for warranties up to 10 year with wind speed coverage up to 55mph.
 - h. The wood nailers are installed relatively flush with the insulation surface and the membrane is to be fastened with seam fastening plates and Carlisle HP or HP-X fasteners on 12" o.c. For wood nailer installation, refer to Design Reference DR-08-11 "Wood Nailers and Securement Criteria".

C. **Mechanically Fastened Roofing Systems**

1. **Carlisle Fasteners and Fastening Plates are required for insulation securement.** Refer to Insulation Fastening Criteria Table in Paragraph 2.05, for appropriate fastener and deck penetration. The fastener can be used with either a 2" diameter Seam Fastening Plate or 2-3/8" diameter Pirahna/Pirahna Xtra Plates OR 3" diameter Insulation Fastening plate.
2. **Any Carlisle approved insulation or cover board** shall be mechanically fastened to the roof deck at the minimum rate of **1.25 fasteners and plates per every 8 square feet** (5 fasteners in a 4 x 8 board) for minimum 1-1/2" thick insulation and coverboards. Insulation greater than 1-1/2" thick requires the use of 8 fasteners and plates in a 4' x 8' board (1 per 4 square feet).

CAUTION: Carlisle Polyisocyanurate Insulation with a thickness less than 1.5" installed over an existing roofing membrane without a tear-off must be mechanically fastened to the roof deck with a minimum of **1 fastener and plate for every 4 square feet** or less of insulation.

3. Use of DensDeck, DensDeck Prime and Dens Deck StormX Prime should be limited to assemblies with slopes greater than 2" per foot to ensure compliance with external fire codes.

3.05 Membrane Placement and Securement

A. General

1. **Ensure** that water does not flow beneath any completed sections of the membrane system by completing all flashings, terminations and daily seals by the end of each workday.
2. **Sweep** all loose debris from the substrate.
3. If aesthetics are of concern, protection should be specified to avoid discoloration of the white membrane surface resulting from adhesive residue or excess foot traffic.
4. In addition to the primary membrane securement (Bonding for Adhered and Fastening for Mechanically Fastened Assemblies), additional membrane securement is required at the perimeter of each roof level, roof section, curb, skylight, interior wall, penthouse, etc., at any inside angle change where slope or combined slopes exceed 2" in one horizontal foot, and at other penetrations in accordance with the applicable Carlisle details. Refer to Paragraph F for additional membrane securement.

B. Membrane Placement

Maximum 10' wide Sure-Flex Membrane is fully adhered or mechanically fastened to an approved insulation or substrate.

1. **Position** Sure-Flex membrane over the acceptable substrate. For a mechanically fastened assembly, ensure proper number of perimeter sheets are positioned along the perimeter of the roof as outlined in Paragraph 1.05 "Warranty Tables".
2. **Position** field sheets perpendicular to the steel deck flutes in Mechanically Fastened Applications.
3. **Place** adjoining membrane sheets in the same manner, overlapping edges appropriately to provide for the minimum overlap width. It is recommended all overlaps be shingled to avoid bucking of water.

C. Membrane Securement / Bonding - Adhered Roofing System

1. **Adhere** Sure-Flex membrane to an acceptable substrate with Carlisle Bonding Adhesive. CAV-GRIP PVC aerosol adhesive may be utilized with Sure-Flex PVC membranes (cannot be used with any KEE or KEE HP bareback membranes). Comply with Labels, Safety Data Sheet (SDS) and Product Data Sheets for installation procedures and use. Adhesive must be applied to both the membrane and the surface to which it is being bonded.
2. On projects at high altitudes (6,000' and above), rapid flash-off (drying) of Bonding Adhesive and Primers will occur due to low atmospheric pressure.
3. **Fold** membrane sheet back so half the underside is exposed. Sheet fold should be smooth without wrinkles or buckles.
4. **Stir** Bonding Adhesive thoroughly scraping the sides and the bottom of the can (minimum 5 minutes stirring is recommended). Bonding surfaces must be dry and clean.
5. **Apply** Bonding Adhesive to the exposed underside of the membrane and the corresponding substrate area. Do not apply Bonding Adhesive along the splice edge of the membrane to be heat welded over adjoining sheet.

When using **Sure-Flex Low-VOC Bonding Adhesive**, a coverage rate of approximately 120 square feet per gallon per one surface (membrane or substrate) or approximately 60 square

feet per gallon per finished surface (includes coverage on both membrane and substrate) shall be achieved. **Apply** adhesive evenly, without globs or puddles with a plastic core, medium nap paint roller to achieve continuous coating of both surfaces. A 9-inch roller will easily fit into the 5-gallon containers.

A mechanical roller dispenser can be used to apply Bonding Adhesive when the continuous coating and coverage rate noted above are maintained. Backrolling is required.

CAUTION: Due to solvent flash-off, condensation may form on freshly applied Bonding Adhesive when the ambient temperature is near the dew point. If condensation develops, possible surface contamination may occur and the application of Bonding Adhesive must be discontinued. Allow the surface to dry and apply a thin freshener coat at the coverage rate which is approximately half the coverage rate stated above to the previously coated surface when conditions allow for continuing.

NOTE: When Aqua Base 120 is specified refer to Spec Supplement G-10-18 "Aqua Base 120 Bonding Adhesive" for application methods and warranty requirements.

6. **Allow** adhesive to flash-off until it does not string but remains tacky to a dry finger touch.

CAUTION: Care must be exercised to ensure proper drying. Avoid thin areas of adhesive because over drying can occur and proper adhesion may not be achieved.

7. **Roll** the coated membrane into the coated substrate while avoiding wrinkles.
8. **Brush** down the bonded section of the membrane sheet immediately after rolling the membrane into the adhesive with a soft bristle push broom to achieve maximum contact.
9. **Fold** back the unbonded half of the sheet and repeat the bonding procedures. **Apply** Bonding Adhesive to the remaining exposed underside of membrane and adjacent substrate and complete this section as described above.
10. **Install** adjoining membrane sheets in the same manner, overlapping edges a minimum of 2 inches to provide for a minimum 1-½ inch heat weld. It is recommended that all splices be shingled to avoid bucking of water.

CAUTION: If aesthetics is of concern, protect completed sections of the roof so Bonding Adhesive will not discolor the membrane surface. Do not place Bonding Adhesive containers or their lids directly on the surface of the Sure-Flex membrane, to avoid rust stains.

D. Membrane Securement / Fastening - Mechanically Fastened Roofing Systems

1. Sure-Flex PVC and KEE HP membranes shall be mechanically attached to the structural deck with specified Carlisle Fasteners and designated Plates, for fastening densities and numbers of perimeter sheets refer to Warranty Tables, Paragraph 1.05.
2. Membrane Fastening Selection Table:

Membrane Fastener Selection

Deck Type	Carlisle Fasteners*	Carlisle Plate	Min. Penetration
Steel or Lightweight Insulating Concrete over Steel**	HP-X	Piranha Plates	3/4"
	HP-Xtra	Piranha-Xtra Plates	
Structural Concrete, rated 3,000 psi or greater	CD-10	Piranha Plates	1"
	HD 14-10	Piranha Plates	
Wood Plank, min. 15/32" thick Plywood or min. 7/16" OSB**	HP-X	Piranha Plates	Min. 1"
	HP-Xtra	Piranha-Xtra Plates	
Cementitious Wood Fiber Gypsum	Polymer Gyptec	Gyptec Plates – 2" Dia.	1-1/2"
	Polymer Gyptec	Gyptec Plates – 2" Dia.	1-1/2"

Refer to Warranty Tables in Paragraph 1.05 for fastening densities and number of perimeter sheets.

*Determine proper fastener length for deck penetration, refer to Table 2.05B.

** For Mechanically Fastened PVC and KEE HP PVC Assemblies, 2-3/4" x 1-1/2" Oval Metal Barbed Fastening Plates can be used in conjunction with HP-X Fasteners for membrane securement. (Not recommended for Insulation Securement)

3. On steel decks, membrane shall be positioned with seams perpendicular to the steel deck flutes. This allows the external forces on the roof assembly to be distributed between multiple steel deck panels. Refer to Design Reference DR-06-19 "Withdrawal Resistance Criteria" in the Carlisle Technical Manual.

4. Perimeter Sheets

The number of perimeter sheets and fastener spacing is dependent on the building height, wind zone location and warranty duration as outlined in Warranty Tables in Paragraph 1.05.

The roof perimeter is defined as all edges of each roof section (i.e., parapets, building expansion joints at adjoining walls, penthouse walls, etc.). When multi-level roofs meet at a common wall, the adjacent edge of the upper roof is treated as a roof perimeter if the difference in height is greater than 10'. Perimeter sheets are not required at the base of the wall at the lower level.

NOTE: Expansion joints, control joints and fire walls in the field of the roof or roof ridges with slopes less than 3" to the horizontal foot are not considered as part of the roof perimeter.

For Sure-Flex membranes, perimeter sheets can be formed by using individual 40.5" or 5'-0" wide sheets.

- a. **Individual perimeter sheets** (PVC - 40.5" or 5' wide) (KEE HP PVC – 5' wide)

Position membrane along the perimeter of the roof over the acceptable insulation/underlayment. The perimeter membrane width from line of securement to line of securement should be approximately 3'-6" to 4'-0" wide.

- b. **Fastening Plates Method**

In lieu of the RUSS securement method, position a row of seam fastening plates in the locations identified in Paragraph 4.b.1 and 4.b.2, secure plates with appropriate fastener and overlay plates with 6" wide Pressure-Sensitive Sure-Weld Cover Strip (TPO Only) overlay the plates as follows:

- i. Projects with Warranties greater than 20 Years OR Sure-Flex projects regardless of warranty duration center 6" wide section of PVC/KEE HP PVC membrane (equal thickness to the deck membrane) over the plates and heat weld the field sheets. Cut edge sealant is not required for PVC or KEE HP PVC.

NOTE: Perimeter sheets can also be formed by positioning Rhinobond plates placed along the center of a field membrane (if heat induction welder is available on job-site). Refer to "Attachment I" for additional information

- c. **Building with Special Conditions:**

Air pressurized buildings, canopies and buildings with large openings where the total wall openings exceed 10% of the total wall area on which the openings are located (such as airport hangars, warehouses and large maintenance facilities) will typically require additional perimeter membrane securement, an increased fastening density or other enhancement.

- d. **Buildings with large openings**

When any wall contains major openings with a combined area which exceeds 10% of the total wall area on which the openings are located, four (4) perimeter sheets (centered over the opening) must be specified as shown.

As an option to the above perimeter securement, an adhered membrane section may be used in lieu of the mechanically fastened membrane at large openings in accordance with the Carlisle Specification for the Sure-Flex Adhered Roofing System.

NOTE: Depth of perimeter area, noted above, shall not be less than 2.5 times the width of the opening.

e. **Buildings with overhangs**

The membrane must be specified with perimeter sheets installed over the entire overhang area extending onto the main roof deck when at the same level.

As an option, an adhered membrane section may be used in lieu of the mechanically fastened membrane at building overhangs in accordance with the Carlisle Specification for the Sure-Flex Adhered Roofing System.

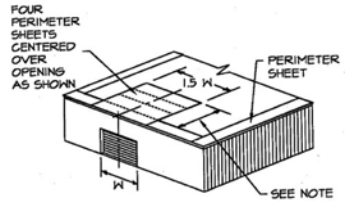

5. **Field Membrane**

- a. **Position** adjoining field membrane sheets to allow an approximate overlap of 5-1/2" at those locations where Fastening Plates are located (along the length of the membrane); at the same time overlap end roll sections (the width of the membrane) a minimum of 2".

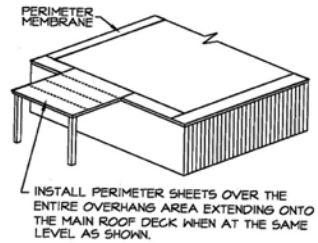

- b. **Secure the membrane** at the approved fastening density with the required Carlisle Fastener and Fastening Plates.
- c. For installation of membrane with fullness, tighten the sheet between fasteners as follows:
- Unroll sheets and position.
 - Place a fastener and plate in one end of the sheet on the appropriate fastener mark. Go to the opposite end of the sheet, pull it tight and place a fastener and plate at the appropriate mark. Place the remaining fasteners into the sheet.
 - Proceed to weld the sheet in place and continue across the roof.

6. **Prevention of membrane distortion during windy conditions:**

- Unroll sheet approximately 5' and position edge of membrane with overlap line on adjacent sheet.
- Install fasteners along the 5' exposed edge.
- While the 5' of exposed membrane is being fastened, begin welding the overlapped edge using the Automatic Heat Welder.
- As sheet is being welded and fastened concurrently, unroll membrane. Unroll only enough membrane to stay a few feet ahead of welding and fastening process. This reduces amount of unsecured membrane to be distorted by wind.
- Continue this process for each adjoining sheet.

E. **SAT (Self-Adhering Technology) – Self-Adhered Roofing System (membrane bonding)**

10' wide Sure-Weld SAT is fully adhered to an approved insulation or substrate with Factory Applied Pressure-Sensitive Adhesive.

- Position** Sure-Weld SAT membrane over the acceptable substrate.
- Fold** membrane sheet back so half the underside is exposed.
- Remove** the release liner on one half of the sheet starting from the split in the liner at the middle of the sheet. The liner should be removed at an angle to reduce risk of splitting or tearing.

4. **Roll** the membrane onto the substrate while avoiding wrinkles. To achieve the best adhesion, the membrane should be rolled onto the substrate at an angle with 30" wide, 150 lb weighted segmented steel roller.
 5. **Fold** back the remaining half of the sheet and repeat the above process.
- F. Additional Membrane Securement
1. Securement must be provided at the perimeter of each roof level, roof section, expansion joint, curb, skylight, interior wall, penthouse, etc., at any inside angle change where slope exceeds 2 inches to one horizontal foot, and at all penetrations as identified on the Carlisle details.
 2. Securement may be achieved as follows:
 - a. On Mechanically Fastened Roofing Systems, Carlisle's Piranha Fastening Plates are used to secure the membrane with the appropriate Carlisle Fastener at the base of walls and penetrations and flashed as shown on the applicable Carlisle detail (excluding OSB, cementitious wood fiber and gypsum decks where the required Carlisle Fastener is installed with the associated 2" diameter plate). On **Adhered Roofing Systems**, Carlisle standard 2" diameter Seam Fastening Plates may be used in lieu of Piranha Plates.
 - b. Securement of the membrane shall be a maximum of 12 inches on center. Fasteners shall be positioned 6 inches minimum to 9 inches maximum from the inside or outside corner.
 - c. On Mechanically Fastened assemblies, additional membrane securement is required around pipes and sealant pockets as shown on the applicable detail. The plates must be positioned a maximum of 12" away from the penetration, spaced a maximum of 12" on center and flashed in accordance with the applicable Carlisle Detail.
 - d. After securing the membrane, flash in accordance with the appropriate detail.

3.06 Heat Welding Procedures

A. General

1. APEEL Protective Film should be removed from within areas that are to be heat-welded together. In areas that do not require heat welding, the APEEL Protective Film can be left in place for up to 90 days.
2. Heat weld the Sure-Flex membrane sheets using the Automatic Heat Welder or Hot Air Hand Welder and silicone roller.
3. When roof slope exceeds 5" per horizontal foot, use of the Automatic Heat Welding Machine may become more difficult; use of the Hand Held Hot Air Welder is recommended.
4. **Check the surfaces** of the membrane to be heat welded to ensure they are properly prepared.

The surfaces to be heat welded must be clean. Membrane overlaps that become contaminated with field dirt must be cleaned with Weathered or PVC and KEE HP Membrane Cleaner (Weathered Membrane Cleaner should not be used to clean Sure-Flex PVC or KEE HP). Weathered or PVC and KEE HP Membrane Cleaner should be wiped dry with a clean HP Splice Wipe prior to welding. No residual dirt or contaminants should be evident.

B. Automatic and/or Hand Held Heat Welder Equipment

1. Refer to **Supplemental Document T-01-18 "Heat Welding Equipment"** for:
 - a. Temperature Settings.
 - b. Equipment Set-up.
 - c. Additional Information.

C. Membrane Welding

1. Prepare the Automatic Heat Welder and allow it to warm for approximately 5 to 10 minutes to reach operating temperature.

2. Position the Automatic Heat Welder properly prior to seaming with the guide handle pointing in the same direction the machine will move along the seam.
3. Lift the overlapping membrane sheet and insert the blower nozzle of the Automatic Heat Welder between the overlap. Machine will begin moving along the seam immediately.
4. Weight plates provided on Automatic Welders must be utilized.
5. Proceed along the seam ensuring that the small guide wheel in front of the machine aligns with the edge of the top membrane sheet. Guide the machine from the front only.

CAUTION: Ensure the power cord has plenty of slack to prevent dragging the machine off course (which could result from a tightly stretched cord).

6. At all splice intersections, roll the seam with a silicone roller to ensure a continuous heat welded seam (the membrane should be creased into any membrane step-off with the edge of the silicone roller). A false weld may result due to surface irregularities created by multiple thicknesses of Sure-Flex membrane sheets.

When using **80-mil** Sure-Flex Membrane, a **PVC "T"-Joint Cover** must be applied over all "T" joint splice intersections.

7. To remove the Automatic Heat Welder from the finished splice, disengage and pull the nozzle from the seam area, the machine will stop automatically.
8. Mark the end of the heat welded seam with a water-soluble marker for easy identification. A Hand Held Welder will be necessary to complete the weld in the area between where the Automatic Heat Welder is stopped and restarted.
9. Perform a test weld, at least, at the start of work each morning and afternoon. Test welds should be made if any changes in substrate or weather conditions occur.

D. Preventing Membrane Creeping During Welding

1. The operator of automatic welding equipment must apply foot pressure to the membrane, keeping the membrane tight under the welder. Refer to **Supplemental Document T-01-18 "Heat Welding Equipment"** for additional information.

E. Test Cuts

1. Perform a test weld at least at the start of work each morning and afternoon. Refer to **Supplemental Document T-01-18 "Heat Welding Equipment"** for additional information.

F. Seam Probing

1. A cotter pin puller (blunt or dull for PVC or KEE HP PVC Membranes) or Carlisle Seam Probe is recommended to probe all heat-welded seams. Probing seams must be done once heat welds have thoroughly cooled. Refer to **Supplemental Document T-01-18 "Heat Welding Equipment"** for additional information.

G. Seam Sealing

Cut-Edge Sealant is not required on cut edges of Sure-Flex membrane (Horizontal or Vertical).

3.07 Welding Problems/Repairs

- A. A Hand Held Hot Air Welder and a 2" wide silicone roller must be used when repairing the Sure-Flex membrane. When the **entire** heat welded **seam** is to be **overlaid**, an **Automatic Heat Welder** may be used.
- B. Prior to proceeding with any repair procedure, the area to be repaired must be cleaned with Weathered or PVC and KEE HP Membrane Cleaner (Weathered Membrane Cleaner should not be used to clean Sure-Flex PVC or KEE HP PVC Membrane). The membrane can typically be repaired with standard cleaning methods. In cases where the standard cleaning method is not sufficient, the following procedures must be used.

1. Scrub the area to be welded with a “Scotch Brite” Pad and Weathered or PVC and KEE HP Membrane Cleaner.
 2. Clean all residue from the area to be welded with a Splice Wipe or a clean natural fiber (cotton) rag.
 3. Weld the new membrane to the cleaned area using standard welding procedures.
- C. Clean all residue from the area to be welded with a Splice Wipe or clean natural fiber (cotton) rag.
- D. Weld the new membrane to the cleaned area using standard welding procedures.
- E. Voids in welded seams can be repaired using a Hand Held Hot Air Welder and a silicone roller. Depending on conditions, a splice overlay may be required.
- F. Position the hand held welder facing into void so hot air is forced between overlapping membranes. Roll the top membrane surface using positive pressure toward the outer edge until the heated membrane surfaces are fused.
- G. Exposed scrim-reinforcement (resulting from scorching surface of membrane) and test weld areas must be repaired by overlaying the damaged area with a separate piece of Sure-Flex reinforced membrane with rounded corners. The overlay must extend a minimum of 2 inches past the area to be repaired.
- H. **Probe** all edges of the overlay once cooled to ensure a proper weld has been achieved.
- I. Cut-Edge Sealant is not required on cut edges of Sure-Flex Membranes.

NOTE: The same overlay repair procedures may be used for punctures in the Sure-Flex membrane.

3.08 Flashings

For other requirements which must be complied with in order for Carlisle warranty to be issued, refer to Spec Supplement G-05-20 “Flashing Considerations / Metal Work”.

A. General Considerations

1. The height of new wall flashing must extend above the anticipated water level or slush line.
2. On 15 or 20-year Warranty projects, Carlisle's Termination Bar, in conjunction with Water Cut-Off Mastic, must be specified under all metal counterflashings and surface mounted reglets.
3. To comply with various warranty options, flashing material must equal the required minimum membrane thickness but shall not be less than 60-mils thick. For projects with 25 year or greater warranties Carlisle Pre-Fabricated accessories must be used unless prohibited by a specific field condition.

4. On retrofit projects

Bitumen-based roof cement and asphaltic-based flashing material, if allowed to remain in contact with the membrane, will cause severe membrane discoloration and for PVC and KEE HP PVC membranes, promote premature plasticizer migration. Existing wall and curb flashing must be removed or concealed with a new acceptable substrate.

- a. The specifier must examine structural supports for rooftop equipment to determine if reasonable access to the membrane beneath the equipment is provided. Carlisle should be consulted for clarification when access to the membrane system will be restricted.
 - b. When hot pipes or other similar penetrations exceed 140°F (60°C) (PVC/KEE HP PVC), they must be designed to incorporate an insulated metal collar and rain hood designed to maintain a surface temperature less than 140°F (60°C) (PVC/KEE HP PVC).
5. Flashing of parapets, curbs, expansion joints and other parts of the roof must be performed using Sure-Flex **reinforced** membrane. Sure-Flex non-reinforced membrane can be used for flashing pipe penetrations, Sealant Pockets and scuppers as well as inside and outside corners when the use of pre-molded accessories is not feasible.

6. When possible, all reinforced membrane splices are heat welded with the Automatic Heat Welder. The Hand Held Hot Air Welder should be utilized in hard to reach areas, smaller curbs, vertical splices and when using non-reinforced membrane.
 - a. The new Sure-Flex membrane flashing must not conceal weep holes or cover existing throughwall flashing.
 - b. Install surface mounted reglets and compression bar terminations directly to the wall surface.
7. In areas where metal counterflashing or surface mounted reglets are used as vertical terminations, the counterflashing must be sealed with a rubber grade caulking to prevent moisture migration behind the new wall flashing.

B. Application of Bonding Adhesive

1. Membrane shall be adhered to vertical surfaces with Sure-Flex Bonding Adhesive. CAV-GRIP PVC aerosol adhesive may be utilized with Sure-Flex PVC membranes (cannot be used with any KEE or KEE HP bareback membranes). Bonding Adhesive shall be applied continuously, without globs or puddles.
2. **Allow** adhesive to flash-off until it is tacky but will not string or transfer to a dry finger touch.
3. Roll the membrane into the adhesive.
4. Care must be taken when setting the flashing to avoid bridging greater than ¾ inch at angle changes (i.e., where a parapet or roof penetration meets the roof deck). This can be accomplished by creasing the membrane into the angle change.
5. Terminate the edges of the installed membrane in accordance with Carlisle's applicable details.
6. When Carlisle termination bar is used beneath the counter-flashing, bonding adhesive can be eliminated when the flashing height is 18" or less.

C. Walls, Parapets, Curbs, Skylights, etc.

The flashing height must be calculated so that the Sure-Flex membrane flashing includes a minimum 1-½ inch heat weld beyond the Fastening Plates.

1. Fasten at angle change as identified in Paragraph 3.05, Additional Membrane Securement, with the required Carlisle Fastener and plate.
2. Flash the fasteners/plates with a separate piece of Sure-Flex reinforced membrane; apply heat and crease the flashing into the angle change before attaching it to the vertical surface.

D. Metal Edge Terminations

Factory-fabricated metal edge systems must be secured to the wood nailer as specified by the manufacturer. Shop-fabricated edging must be installed in compliance with appropriate Carlisle Detail using Carlisle PVC Coated Metal in order to achieve ES-1 Compliance. Refer to the appropriate Universal Details for other flashing options and requirements.

E. Roof Drains

1. Sure-Flex membrane may extend into the drain sump when the slope of the sump is less than 3" to one horizontal foot.
 When the drain sump is greater than 3" to one horizontal foot, additional membrane securement must be installed.
2. Only drain strainers that have been approved by the specifier in accordance with applicable codes may be used.

F. Sure-Flex Contour Rib Profiles

1. The Contour Rib Profile is recommended for use with FleeceBACK PVC adhered roofing systems.

2. The Sure-Flex Contour Rib Profiles should be positioned parallel to the laps of the installed PVC roofing system and parallel with the roof slope where possible.
3. Ensure that all welding surfaces are clean and dry. Inspect all seam areas for proper weld prior to installing Sure Flex Contour Rib Profile.
4. Contour Rib Profile spacing can be individually determined to achieve the desired appearance.
5. Connecting multiple ribs is achieved by using fiberglass pins. Insert a pin half-way into the end of one profile. Connect the adjoining rib by inserting the exposed end of the pin into the alignment hole. Repeat previous steps for additional PVC Contour Rib profiles.
6. Consult the Sure Flex Contour Rib Profile installation guides for instructions on proper installation techniques.

G. **Other Penetrations**

On Mechanically Fastened assemblies, additional membrane securement is required around pipes and sealant pockets as shown on the applicable detail. The plates must be positioned a maximum of 12" away from the penetration, spaced a maximum of 12" on center and flashed in accordance with the applicable Carlisle Detail.

1. **Pipes, Round Supports, etc.**

- a. Flash pipes with Molded Pipe Flashings or Split Pipe Seals where their installation is possible. Molded pipe flashings cannot be cut and patched; deck flanges cannot be overlapped or installed over angle changes.
- b. Where Molded Pipe Flashings or Split Pipe Seals cannot be installed, APPLY FIELD FABRICATED PIPE FLASHING using Sure-Flex non-reinforced membrane.

2. **Flexible Penetrations** (braided cables, conduits, wires, etc.) must be enclosed in a stable "goose neck." Apply a Split Pipe Seal or field fabricated pipe flashing to flash the goose neck.
3. **Hot pipes** that exceed 140°F (60°C) (PVC/KEE HP PVC), must utilize an insulated metal collar and rain hood, flashed with a field fabricated pipe flashing.
4. For **pipe clusters** or unusually shaped penetrations, a Molded Sealant Pocket and White One Part Sealant must be utilized.
5. **Existing Roof Tie-Ins** for PVC or KEE HP PVC membranes refer to applicable Carlisle details for tie-ins.
6. **Flashing of Difficult Penetrations**, refer to Spec Supplement G-13-20 for "LIQUISEAL Liquid Flashing" for additional information and specific requirements.

H. **APEEL Protective Film (Optional)**

When the optional APEEL Protective Film is utilized on PVC/KEE HP, remove and discard the APEEL Protective Film after the installation of the entire PVC/KEE HP Roofing System is complete.

3.09 Roof Walkways

Walkways are to be specified at all traffic concentration points (i.e., roof hatches, access doors, rooftop ladders, etc.), and if regular maintenance (once a month or more) is necessary to service rooftop equipment. Refer to Spec Supplement G-06-19 "Roof Walkway Installation".

3.10 Daily Seal

On phased roofing, when the completion of flashings and terminations is not possible by the end of each workday, provisions must be taken to temporarily close the membrane to prevent water infiltration. Refer to Spec Supplement G-07-20 "Daily Seal & Clean Up".

SECTION 7: DAILY PROCEDURES

Daily Seal

1. On phased roofing, when the completion of flashings and terminations is not possible by the end of each workday, provisions must be taken to temporarily close the membrane to prevent water infiltration.
2. Temporarily seal any loose membrane edge down slope using Flexible FAST Adhesive, hot asphalt, or a similar product so that the membrane edge will not buck water. Caution must be exercised to ensure positive draining during installation, temporary seal locations should be designated so that drainage is not restricted during construction by partially installed roof sections.
 - a. When applying Flexible FAST Adhesive or other sprayed urethane foam, prime the surface of the membrane with Carlisle Primer to ensure proper adhesion
3. When tie-in to existing built-up roofs, remove the gravel. The surface must be clean and dry.
4. After embedding membrane in daily seal material, CHECK FOR CONTINUOUS CONTACT. Provide continuous pressure over the length of the temporary seal. Provide weight evenly distributed along the length of the daily seal to reduce the wind effect on the continuous temporary seal.

NOTE: The use of rigid wood nailers is not recommended due to warping. Constant compression cannot be achieved on an uneven substrate.
5. When work is resumed, pull the imbedded membrane free; trim and remove daily seal material from membrane before continuing installation of adjoining sections.

Clean Up

1. If required by the specifier to ensure the aesthetics of the surface of the membrane, hand prints, footprints, general traffic grime, industrial pollutants and environmental dirt may be cleaned from the surface of the membrane by scrubbing with soapy (non-abrasive soap) water and rinsing the area completely with clean water.
 - a. For Sure-Weld membrane, Weathered Membrane Cleaner can be used to clean the surface of the membrane.
 - b. For Sure-Flex Membrane, PVC Membrane Cleaner can be used to clean the surface of the membrane.
2. Bonding Adhesive and Flexible FAST Adhesive residue may be cleaned by using the following procedures:
 - a. Saturate a clean HP Splice Wipe with Weathered Membrane Cleaner or PVC Membrane Cleaner (PVC).
 - b. Scrub exposed adhesive with the saturated HP Splice Wipe until all residue is removed from the membrane. For easier removal, it may be necessary to change Splice Wipes frequently.

Test Welds

1. Perform a test weld at least at the start of work each morning and afternoon.
2. The test sample should be approximately 1 inch wide and longer than the width of the seam (cut across the heat welded seam).
3. Peel the test sample apart after it has thoroughly cooled (approximately 10 minutes) and examine for a consistent 1½" inch wide minimum weld. Delamination of the membrane from the scrim-reinforcement is an indication of a properly welded seam.

4. Identify the following seam problems to assure seam quality:
 - a. Discolored or scorched membrane - Increase speed or decrease temperature setting if membrane discolors.
 - b. Voids and wrinkles - A proper heat welded seam has no voids or wrinkles and must be at least 1½" inches wide. Refer to Seam Probing procedures outlined below for proper inspection of seam deficiencies.

Seam Probing

A blunt or dull cotter pin puller is recommended to probe all heat-welded seams. Probing seams must be done once heat welds have thoroughly cooled. Heat welded seams must be probed throughout the day to check seam quality and to make proper adjustments to heat welding equipment. The repair of deficiencies must be done routinely throughout the day but no later than the end of each workday.

1. Allow heat-welded seams to cool thoroughly for approximately 30 minutes. Premature probing can damage warm seams.
2. Draw probing tool tip along the edge of the heat welded seam. Apply firm pressure to probe the seam junction, but not into the bottom membrane sheet. The tool will not penetrate the lap area of a properly welded seam
3. If the seam-probing tool penetrates the lap area, mark the seam using a water-soluble marker at the beginning and the end of voids or wrinkles in the seam edge.
4. Carlisle recommends repairing seam deficiencies as soon as possible using the hand-held welder.

Inspection Process

1. Before roofing begins, an accurate design of the roof should be submitted into Carlisle's Project Review team to be reviewed. Once approved by Carlisle, the NOA (Notice of Award) will be given in return with a 7-digit job number. Roofing should then begin as scheduled.

NOTE: Please be aware of any special design specifications noted on NOA.

2. Once the roof is 100% completed per Carlisle Specifications, the NOC (Notice of Completion) is submitted into Carlisle, informing us the job is complete. Once this is submitted, within 24 hours, the job will be assigned to the appropriate Carlisle Field Service Representative (FSR) for that area.

NOTE: Please provide an accurate drawing and accurate address of the job.





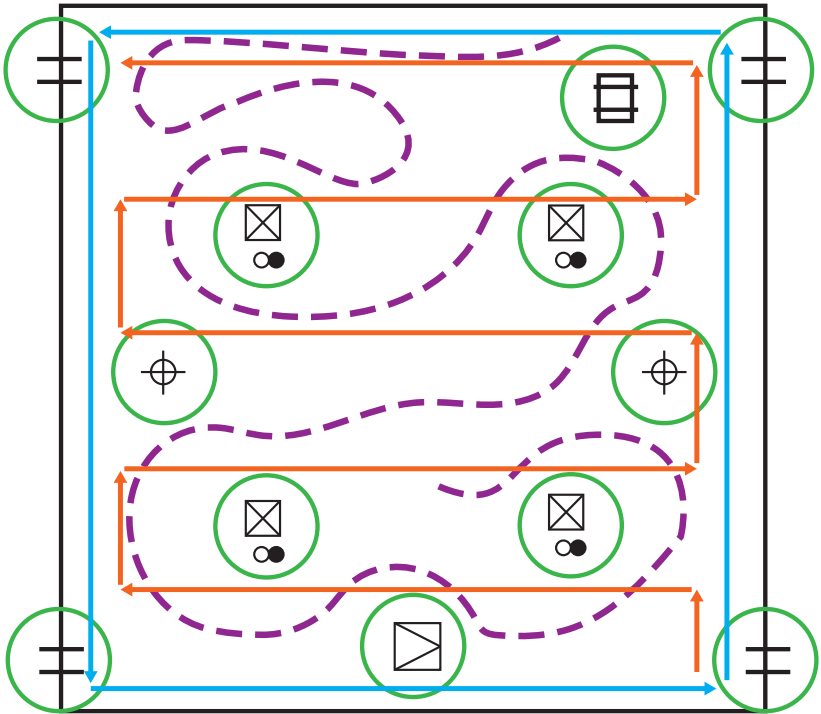

3. The assigned Carlisle FSR will give roofer a 48-hour notice on when he/she would be able to conduct a final inspection.
4. The day of the final inspection, Carlisle would prefer the roofer to be present and roof access be provided.

NOTE: Having a crew present during the inspection helps with the inspection process by repairing any issues during the inspection.

5. The inspection process begins as followed:

NOTE: All hand welded areas/details shall be probed 100% and all welds by robot shall be probed a minimum 10' for every 100-foot seam while walking perimeter and seams.



- | | | | |
|---|-----------------------------|--|-----------|
|  | - Roof Hatch |  | - Scupper |
|  | - Curb |  | - Drain |
|  | - Pipe |  | - Sleeper |
|  | - Pourable
Sealer Pocket | | |

Step 1: Inspect the perimeter.

Update the roof plan to show the location of all curbs, penetrations, drains, etc. Focus on securement and termination. Mark deficiencies on the roof plan as they are found.

Step 2: Inspect all seams on the roof level.

Focus on plate placement and proper seaming.

Step 3: Inspect all curbs, penetrations, drains, etc.

Focus on one detail at a time, confirming proper securement, termination, and flashing minimums.

Step 4: Finally, walk across the roof, update areas in need of repair, and perform a general check of the system.

TABLE OF CONTENTS

Insulation Details	99
A-27A Carlisle Insulation / Cover Board Attachment	99
A-27B Minimum 2"-Thick InsulBase / SecurShield Polyisocyanurate.....	100
A-27C Minimum 1½"-Thick InsulBase / SecurShield Polyisocyanurate	101
A-27D ¼"- or ½"-Thick SECUROCK or DensDeck Prime	102
A-27E ⅝"-Thick SECUROCK or DensDeck Prime.....	103
A-27F Carlisle StormBase (OSB/ Polyisocyanurate Composite) Attachment.....	104
A-27G Insulation / Cover Board Attachment Using Bead Adhesive	105
MF-27 Insulation / Cover Board Attachment For All Warranty Durations	106
MF-27C R-Tech Fanfold Roof Underlayment	107
MF-27D R-Tech Fanfold Roof Underlayment for FM Assemblies	108
MF-27E Insulation/Coverboard Attachment When Using SecurShield Family Products for All Warranties Lengths.....	109
Main Details	110
Mechanically Fastened Details	
MF-2 Membrane Securement	110
MF-2.1 TPO Membrane Securement with Pressure-Sensitive RUSS	111
MF-2A Mechanically Fastened Membrane Splice	112
MF-2B Fastener and Plate Placement	113
MF-22 Ridge Membrane Attachment	114
Metal Edges and Gravel Stops	
U-1A SecurSeal Drip Edge Fascia	115
U-1B SecurWeld Coated Drip Edge Fascia	116
U-1C Metal Bar Edge Termination	117
U-1D Carlisle SecurEdge 200	118
U-1E Carlisle SecurEdge 300	119
U-1F Carlisle SecurEdge 2000 & 3000.....	120
U-1G Pressure-Sensitive PVC / KEE HP Cover Strip	121
Membrane Splices	
U-2A Membrane Splice	122
U-2B Thermoplastic Membrane Splices	123
Expansion Joints	
U-3A Deck-to-Deck Expansion Detail	124
U-3B Deck-to-Wall Expansion Detail	125
Curb Flashing	
U-5A Curb Flashing with TPO or PVC Membrane	126
U-5B Curb Flashing with TPO or PVC Coated Metal	127
U-5C Curb Flashing with CFA TPO or PVC Curb Wrap Corners	128
U-5D Self-Flashing Curb with CFA TPO or PVC Curb Wrap Corners	129
Drains	
U-6A Roof Drain (Drain Sump up to 3 inches to 1 Horizontal Foot.....	130
U-6B Roof Drain (Drain Sump Greater than 3 inches to 1 Horizontal Foot) Option 1	131
U-6C Roof Drain (Drain Sump Greater than 3 inches to 1 Horizontal Foot) Option 2 (Page 1 of 2)	132
U-6C.1 Roof Drain (Drain Sump Greater than 3 inches to 1 Horizontal Foot) Option 2 (Page 2 of 2).....	133
U-6D Add-On Drain	134
Pipe Flashing	
U-8A Pre-Molded Pipe Flashing	135
U-8B Field Fabricated Pipe Flashing	136
U-8C CFA Certified Pre-Fabricated Square Tube Wrap	137
U-8D Field-Fabricated Square Tube Flashing	138
U-8D.1 Field Fabricated Hot Stack (25/30 Year Warranties)	139
U-8E CFA Certified Pre-Fabricated Split Pipe Seal	140
U-8F CFA Certified Hot Pipe Flashing	141

Terminations	
U-9 Membrane Terminations (Page 1 of 2)	142
U-9 Membrane Terminations (Page 2 of 2)	143
Parapet Flashing	
U-12A Parapet Flashing Fastened into Deck	144
U-12A.1 Parapet Flashing Fastened into Wall	145
U-12B Parapet Flashing with Pressure-Sensitive RUSS (Page 1 of 2)	146
U-12B.1 Parapet Flashing with Pressure-Sensitive RUSS (Page 2 of 2)	147
U-12C Coated Metal Wall Flashing	148
U-12F Parapet Flashing / No Adhesion – Any Height Option	149
U-12G TPO SAT Parapet Flashing with TPO RUSS	150
U-12H TPO SAT Parapet Flashing with TPO SAT RUSS	151
Tie-Ins	
U-13A TPO Tie-In to Built-Up Roofing Over Steel Roof Deck	152
U-13B TPO Tie-In to Built-Up Roofing Over Concrete Roof Deck	153
U-13C TPO/PVC Tie-In to Existing Single-Ply	154
U-13D TPO Tie-In to Existing EPDM Membrane	155
U-13E EPDM Tie-In on Concrete Deck	156
U-13F TPO/PVC Tie-In to Shingled or Metal Panel Roof	157
U-13G PVC/KEE HP Tie-In to Existing Single-Ply Membrane on Concrete Deck	158
U-13H PVC/KEE HP Tie-In to Existing Single-Ply Membrane on Metal Deck	159
Inside/Outside Corners	
U-15A Pre-Molded Inside Corner Flashing	160
U-15B Field Fabricated Inside Corner Flashing	161
U-15C Inside Corner with Coated Metal Flashing	162
U-15D Pre-Molded Outside Corner Flashing	163
U-15E Field Fabricated Outside Corner Flashing	164
U-15F Outside Corner with Coated Metal Wall Flashing	165
U-15G PVC or TPO Universal Corners- Combination Inside & Outside Corners	166
Sealant Pocket	
U-16A Molded Sealant Pocket	167
Through-Wall Scupper	
U-18A Scupper with Coated Metal	168
U-18B Scupper at Deck - TPO	169
U-18C Scupper with Sure-Flex Non-Reinforced PVC/ KEE HP Flashing	170
U-18D Scupper with Sure-Flex Non-Reinforced PVC/ KEE HP PS Cover Strip Flashing	171
Lightning Rods	
U-20A Lightning Rod at Parapet (Vertical Attachment)	172
U-20B Lightning Rod at Deck Level	173
Sleeper	
U-24 Sleeper Detail	174
Induction Welding Details	175
FP-1 Induction Welding Attachment Method – Fastening Patterns/Enhancements	177
FP-2 Induction Welding Attachment Method – Fastening Patterns/Enhancements	178
IW-1 IsoWeld Attachment Method – Number of Fasteners and Location	179
IW-2 Angle Change Securement Method with IsoWeld Plates	180
IW-3 IsoWeld Wall Attachment	181
RB-1 RhinoBond Attachment Method – Number of Fasteners and Location	182
RB-2 Angle Change Securement Method with RhinoBond Plates	183
RB-3 RhinoBond Wall Attachment	184
Liquid Flashing Details	185
Attachment 1- Inspection, Cleaning & Substrate Preparation (Page 1 of 2)	188
Attachment 1- Inspection, Cleaning & Substrate Preparation (Page 2 of 2)	189
Attachment 2- Application of LIQUISEAL Primer & Resin	190
LF-1.1 Sheet Metal Drip Edge or Gravel Stop Flashing	191
LF-8.1 Single and Multiple Pipe Penetrations (Page 1 of 2)	192

LF-8.1 Single and Multiple Pipe Penetrations (Page 2 of 2).....	193
LF-13.1 EPDM Membrane Tie-in with Existing Roof over Steel Deck	194
LF-13.2 TPO or PVC Membrane Tie-in with Existing Roof over Steel Deck (Page 1 of 2).....	195
LF-13.2 TPO or PVC Membrane Tie-in with Existing Roof over Steel Deck (Page 2 of 2).....	196
LF-13.3 Membrane Tie-in with Existing Roof over Concrete Deck.....	197
LF-18.1 Through-Wall Scupper	198
LF-30.1 Steel I-Beam Flashing (Page 1 of 2)	199
LF-30.1 Steel I-Beam Flashing (Page 2 of 2)	200
TPO Flashing Procedures Utilizing Sure-White EPDM Flashing Products Details.....	201
MF-8BT Field-Fabricated Pipe Seal	203
U-1AT SecurSeal Drip Edge Fascia with Sure-White EPDM.....	204
U-5AT Curb / Wall with Sure-White EPDM & Sure-White SecurTape.....	205
U-5BT Curb with 20"-Wide Sure- White EPDM Pressure-Sensitive Cured Flashing	206
U-8AT Pipe: Pre-Molded Pressure-Sensitive Sure-White EPDM Pipe Seal	207
U-8DT Hot Stack: Field Fabricated Flashing with Sure-White PS Elastoform	208
U-12AT Parapet/Curb with Sure-White EPDM and Sure-White SecurTAPE	209
U-15CT Sure-White Pressure-Sensitive Inside Corner with Continuous TPO Wall Flashing	210
U-15ET Outside Corner with Pre-Cut Pressure-Sensitive Flashing (Option 1)	211
U-15GT Outside Corner with Pressure-Sensitive EPDM Flashing (Option 2)	212
U-16BT Pressure-Sensitive Pourable Sealer Pocket	213
U-18BT Scupper at Deck with Pressure Sensitive Elastoform	214
VacuSeal Details.....	215
V-0.1 Roof Assembly Over Existing Single-Ply Roof	215
V-0.2 Roof Assembly Over Existing Asphaltic Roof	216
V-0.3 Roof Assembly Over Steel Deck	217
V-0.4 Roof Assembly Over Poured-in-Place Concrete Deck	218
V-0.5 Roof Assembly Over Concrete Planks.....	219
V-0.6 Roof Assembly Over Lightweight Concrete Deck.....	220
V-0.7 Roof Assembly Over Wood Deck	221
V-1.1 Roof Edge: Roof Recover	222
V-1.2 Roof Edge: Tear-Off & Reroofing.....	223
V-5.1 Curb Base Flashing - New Construction and Re-Roof (Recover)	224
V-6.1 Roof Drain: Re-Roof (Recover)	225
V-6.2 Roof Drain: New Construction	226
V-8.0 VacuSeal™ Vent with Pre-Applied Skirt Flashing.....	227
V-8.1 Pipe/Structural Steel Tube Through Metal Deck.....	228
V-8.2 Multiple Penetrations Through Steel Deck - New Construction	229
V-8.3 Single Penetration Through Existing Roof Assembly	230
V-8.4 Cluster of Penetrations Through Existing Roof Assembly	231
V-8.5A Hot Stack Air Flashing - Option A	232
V-8.5B Hot Stack Air Flashing - Option B.....	233
V-12.1 Parapet with Membrane Air Barrier	234
V-12.2 Parapet/Curb: Concrete/Lightweight Concrete Used as an Air Barrier	235
V-12.3 Parapet or Wall - New Construction and Re-Roof (Recover).....	236
Contact Information.....	237

SECTION 8: DETAILS

SPEC SUPPLEMENT INSULATION/ COVER BOARD

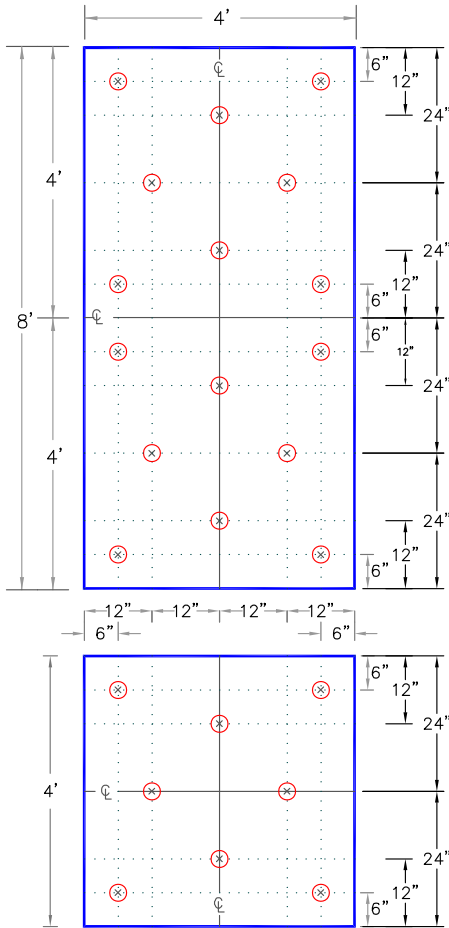

NOTES:

1. WHEN ENHANCED INSULATION FASTENING IS REQUIRED AS PRESCRIBED IN FACTORY MUTUAL LOSS PREVENTION DATA SHEET 1-29, ANSI/SPRI WD-1, OR MIAMI-DADE COUNTY, REFER TO [CARLISLE'S DESIGN REFERENCE DR-05-18](#).
2. FOR CRITERIA ON INSULATION FASTENERS AND PLATES, REFER TO CARLISLE SPECIFICATIONS.
3. IF A WIND SPEED WARRANTY GREATER THAN 55 MILES PER HOUR (25 METERS PER SECOND) OR A WARRANTY TERM GREATER THAN 20-YEARS IS SPECIFIED OR FOR SYSTEMS OVER 50'(15METERS), ADDITIONAL FASTENING MAY BE REQUIRED, REFER TO CARLISLE SPECIFICATIONS.

FEET TO CENTIMETERS		INCHES TO CENTIMETERS																				
4'	8'	inch	1/8"	1/4"	15/32"	1/2"	5/8"	3/4"	1"	1.5"	2"	2.5"	3"	4"	6"	8"	9"	11"	12"	18"	24"	36"
		cm	0.5	1	1.2	1.5	1.6	2	2.5	4	5	6.5	7.5	10	15	20	23	28	30	46	61	91

 	<p>FASTENER & PLATE</p> <p>CENTER LINE</p> <p>GUIDE LINE</p>	<p>CARLISLE INSULATION/ COVER BOARD ATTACHMENT</p> <p>For additional information, refer to Specifications</p>	 DETAIL NO. A-27A ADHERED SYSTEM
----------	--	--	--

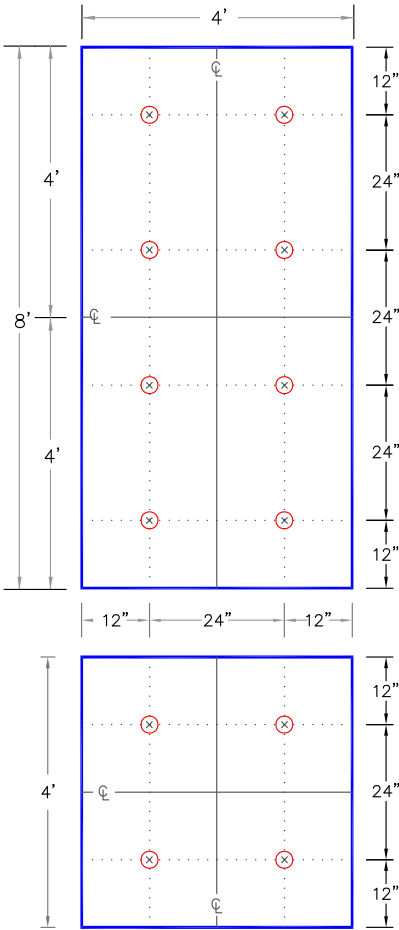

NOTES:

1. THIS DETAIL APPLIES TO MIN. 2" (51mm) THICK (SINGLE OR TOP LAYER) CARLISLE POLYISOCYANURATE INSULATION WHEN FASTENED INTO 22-GAUGE (0.8mm) STEEL, STRUCTURAL CONCRETE, MINIMUM 15/32" (12mm) PLYWOOD OR 1-1/2" (40mm) THICK WOOD PLANK ROOF DECKS.
2. WHEN ENHANCED INSULATION FASTENING IS REQUIRED AS PRESCRIBED IN FACTORY MUTUAL LOSS PREVENTION DATA SHEET 1-29, ANSI/SPRI WD-1 OR MIAMI-DADE COUNTY, REFER TO [CARLISLE'S DESIGN REFERENCE DR-05-18](#).
3. FOR CRITERIA ON INSULATION FASTENERS AND PLATES, REFER TO CARLISLE SPECIFICATIONS.
4. IF A WIND SPEED WARRANTY GREATER THAN 55 MILES PER HOUR (25 METERS PER SECOND) OR A WARRANTY TERM GREATER THAN 20-YEARS IS SPECIFIED OR FOR SYSTEMS OVER 50'(15METERS), ADDITIONAL FASTENING MAY BE REQUIRED, REFER TO CARLISLE SPECIFICATIONS.
5. DETAIL NOT FOR USE OVER ORIENTED STRAND BOARD, GYPSUM, CEMENTITIOUS WOOD FIBER (TECTUM), LIGHTWEIGHT INSULATING CONCRETE OR STEEL ROOF DECK THINNER THAN 22-GAUGE (0.8mm), [REFER TO DETAIL A-27A](#) FOR ACCEPTABLE FASTENING.

FEET TO CENTIMETERS		INCHES TO CENTIMETERS																				
4'	8'	inch	1/8"	1/4"	15/32"	1/2"	5/8"	3/4"	1"	1.5"	2"	2.5"	3"	4"	6"	8"	9"	11"	12"	18"	24"	36"
120	250	cm	0.5	1	1.2	1.5	1.6	2	2.5	4	5	6.5	7.5	10	15	20	23	28	30	46	61	91
FASTENER & PLATE CENTER LINE GUIDE LINE		MINIMUM 2" THICK CARLISLE HP-H / INSULBASE / SECURSHIELD POLYISOCYANURATE INSULATION For additional information, refer to Specifications																				
																DETAIL NO. A-27B ADHERED SYSTEM						

SPEC SUPPLEMENT INSULATION / COVER BOARD

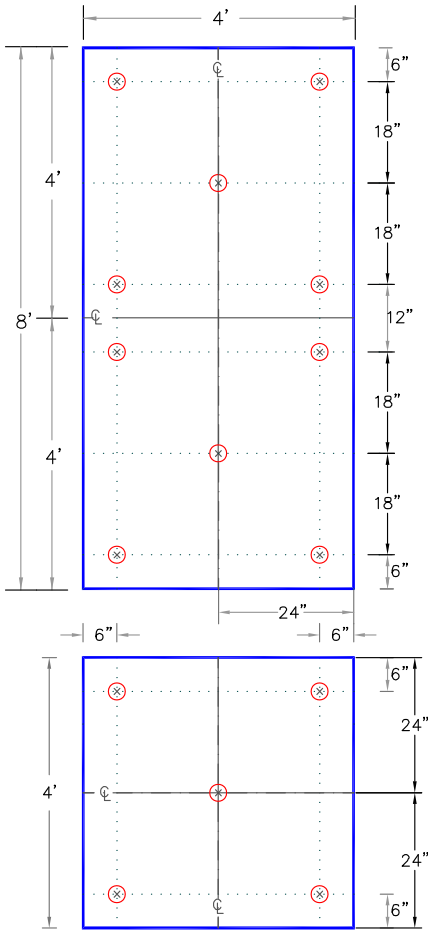

NOTES:

1. THIS DETAIL APPLIES TO MIN. 1-1/2" (40mm) THICK (SINGLE OR TOP LAYER) CARLISLE POLYISOCYANURATE INSULATION WHEN FASTENED INTO 22-GAUGE (0.8mm) STEEL, STRUCTURAL CONCRETE, MINIMUM 15/32" (12mm) PLYWOOD OR 1-1/2" (40mm) THICK WOOD PLANK ROOF DECKS.
2. WHEN ENHANCED INSULATION FASTENING IS REQUIRED AS PRESCRIBED IN FACTORY MUTUAL LOSS PREVENTION DATA SHEET 1-29, ANSI/SPRI WD-1 OR [CARLISLE'S DESIGN REFERENCE DR-05-18](#).
3. FOR CRITERIA ON INSULATION FASTENERS AND PLATES, REFER TO CARLISLE SPECIFICATIONS.
4. IF A WIND SPEED WARRANTY GREATER THAN 55 MILES PER HOUR (25 METERS PER SECOND) OR A WARRANTY TERM GREATER THAN 20-YEARS IS SPECIFIED OR FOR SYSTEMS OVER 50'(15METERS), ADDITIONAL FASTENING MAY BE REQUIRED, REFER TO CARLISLE SPECIFICATIONS.
5. THIS DETAIL NOT FOR USE OVER ORIENTED STRAND BOARD, GYPSUM, FIBROUS CEMENT (TECTUM), LIGHTWEIGHT INSULATING CONCRETE OR STEEL ROOF DECK THINNER THAN 22-GAUGE (0.8mm), [REFER TO DETAIL A-27.1](#) FOR ACCEPTABLE FASTENING.

FEET TO CENTIMETERS		INCHES TO CENTIMETERS																				
4'	8'	inch	1/8"	1/4"	15/32"	1/2"	5/8"	3/4"	1"	1.5"	2"	2.5"	3"	4"	6"	8"	9"	11"	12"	18"	24"	36"
120	250	cm	0.5	1	1.2	1.5	1.6	2	2.5	4	5	6.5	7.5	10	15	20	23	28	30	46	61	91

	MINIMUM 1-1/2" THICK CARLISLE HP-H / INSULBASE / SECURSHIELD POLYISOCYANURATE INSULATION		DETAIL NO.
	For additional information, refer to Specifications		A-27C
			ADHERED SYSTEM

© 2023 Carlisle SynTec a division of Carlisle Construction Materials Incorporated

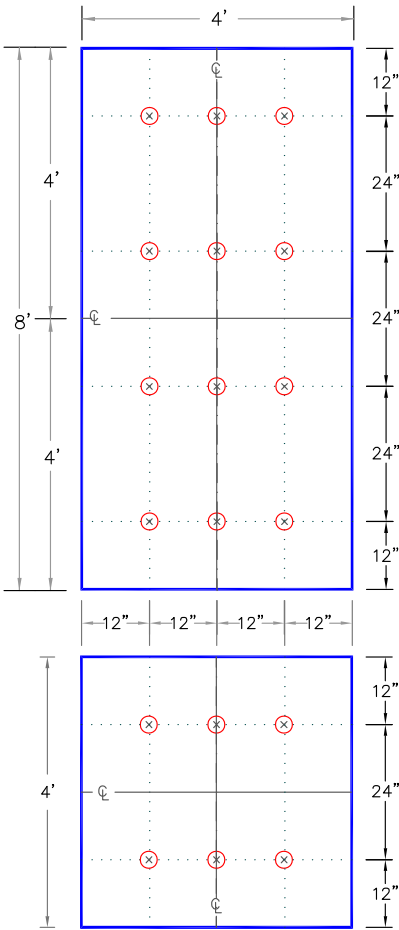

NOTES:

1. THIS DETAIL APPLIES TO 1/4" (10mm) AND 1/2" (15mm) THICK SECUROCK OR DENS DECK PRIME (OVER AN APPROVED INSULATION) WHEN FASTENED INTO 22-GAUGE (0.8mm) STEEL, STRUCTURAL CONCRETE, MINIMUM 15/32" (12mm) PLYWOOD OR 1-1/2" (40mm) THICK WOOD PLANK ROOF DECKS.
2. WHEN ENHANCED FASTENING IS REQUIRED AS PRESCRIBED IN FACTORY MUTUAL LOSS PREVENTION DATA SHEET 1-29, ANSI/SPRI WD-1 OR MIAMI-DADE COUNTY, REFER TO [CARLISLE'S DESIGN REFERENCE DR-05-18](#).
3. FOR CRITERIA ON INSULATION FASTENERS AND PLATES, REFER TO CARLISLE SPECIFICATIONS.
4. IF A WIND SPEED WARRANTY GREATER THAN 55 MILES PER HOUR (25 METERS PER SECOND) OR A WARRANTY TERM GREATER THAN 20-YEARS IS SPECIFIED OR FOR SYSTEMS OVER 50'(15METERS), ADDITIONAL FASTENING MAY BE REQUIRED, REFER TO CARLISLE SPECIFICATIONS.
5. DETAIL NOT FOR USE OVER ORIENTED STRAND BOARD, GYPSUM, FIBROUS CEMENT (TECTUM), LIGHTWEIGHT INSULATING CONCRETE OR STEEL ROOF DECK LESS THAN 22-GAUGE (0.8mm), [REFER TO DETAIL A-27.1](#) FOR ACCEPTABLE FASTENING.
6. WHEN INSTALLED OVER COMBUSTIBLE WOOD DECKS OR INSULATIONS, ALL JOINTS SHALL BE STAGGERED.
7. LONG UNINTERRUPTED RUNS GREATER THAN 200' (>61 METERS) OF SECUROCK MAY REQUIRE SLIGHT GAPPING DUE TO THERMAL EXPANSION.

FEET TO CENTIMETERS		INCHES TO CENTIMETERS																				
4'	8'	inch	1/8"	1/4"	15/32"	1/2"	5/8"	3/4"	1"	1.5"	2"	2.5"	3"	4"	6"	8"	9"	11"	12"	18"	24"	36"
120	250	cm	0.5	1	1.2	1.5	1.6	2	2.5	4	5	6.5	7.5	10	15	20	23	28	30	46	61	91

⊗	FASTENER & PLATE	1/4" OR 1/2" THICK SECUROCK OR DENS DECK PRIME		DETAIL NO.
C	CENTER LINE			A-27D
---	GUIDE LINE	For additional information, refer to Specifications		ADHERED SYSTEM

SPEC SUPPLEMENT INSULATION/ COVER BOARD

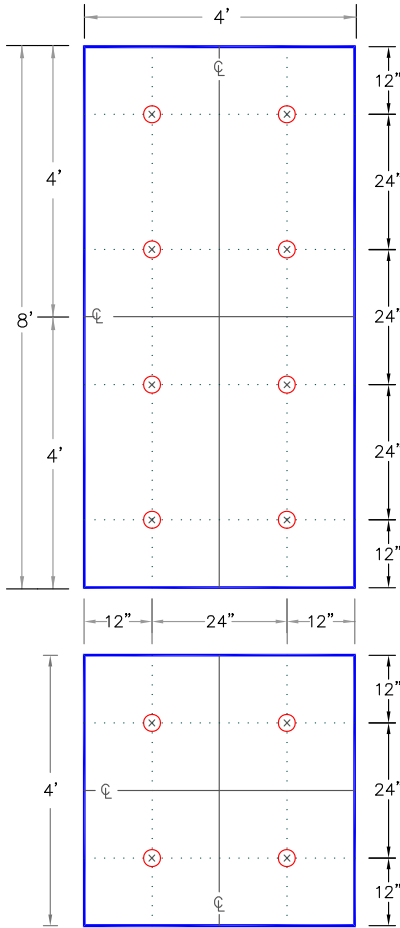

NOTES:

1. THIS DETAIL APPLIES TO 5/8" (16mm) THICK SECUROCK, DENS DECK PRIME, DENS DECK STORMX PRIME OR STORMBASE POLYISO (OVER AN APPROVED INSULATION) WHEN FASTENED INTO 22-GAUGE STEEL, STRUCTURAL CONCRETE, MINIMUM 15/32" (12mm) PLYWOOD OR 1-1/2" (40mm) THICK WOOD PLANK ROOF DECKS.
2. WHEN ENHANCED FASTENING IS REQUIRED AS PRESCRIBED IN FACTORY MUTUAL LOSS PREVENTION DATA SHEET 1-29, ANSI/SPRI WD-1 OR MIAMI-DADE COUNTY, REFER TO [CARLISLE'S DESIGN REFERENCE DR-05-18](#).
3. FOR CRITERIA ON INSULATION FASTENERS AND PLATES, REFER TO CARLISLE SPECIFICATIONS.
4. IF A WIND SPEED WARRANTY GREATER THAN 55 MILES PER HOUR (25 METERS PER SECOND) OR A WARRANTY TERM GREATER THAN 20-YEARS IS SPECIFIED OR FOR SYSTEMS OVER 50' (15 METERS), ADDITIONAL FASTENING MAY BE REQUIRED, REFER TO CARLISLE SPECIFICATIONS.
5. DETAIL NOT FOR USE OVER ORIENTED STRAND BOARD, GYPSUM, FIBROUS CEMENT (TECTUM), LIGHTWEIGHT INSULATING CONCRETE OR STEEL ROOF DECK LESS THAN 22-GAUGE (0.8mm). [REFER TO DETAIL A-27.1](#) FOR ACCEPTABLE FASTENING.
6. WHEN INSTALLED OVER COMBUSTIBLE WOOD DECKS OR INSULATIONS, ALL JOINTS SHALL BE STAGGERED.
7. LONG UNINTERRUPTED RUNS GREATER THAN 200' (> 61M) OF SECUROCK MAY REQUIRE SLIGHT GAPPING DUE TO THERMAL EXPANSION.
8. STORMBASE POLYISO ACHIEVES UP TO A 20-YEAR, 90-MPH WARRANTY WITH (8) FASTENERS.

FEET TO CENTIMETERS		INCHES TO CENTIMETERS																				
4'	8'	inch	1/8"	1/4"	15/32"	1/2"	5/8"	3/4"	1"	1.5"	2"	2.5"	3"	4"	6"	8"	9"	11"	12"	18"	24"	36"
120	250	cm	0.5	1	1.2	1.5	1.6	2	2.5	4	5	6.5	7.5	10	15	20	23	28	30	46	61	91

	FASTENER & PLATE CENTER LINE GUIDE LINE	5/8" THICK SECUROCK, DENS DECK PRIME DENS DECK STORMX PRIME OR STORMBASE POLYISO For additional information, refer to Specifications		DETAIL NO. A-27E ADHERED SYSTEM
--	---	---	--	--

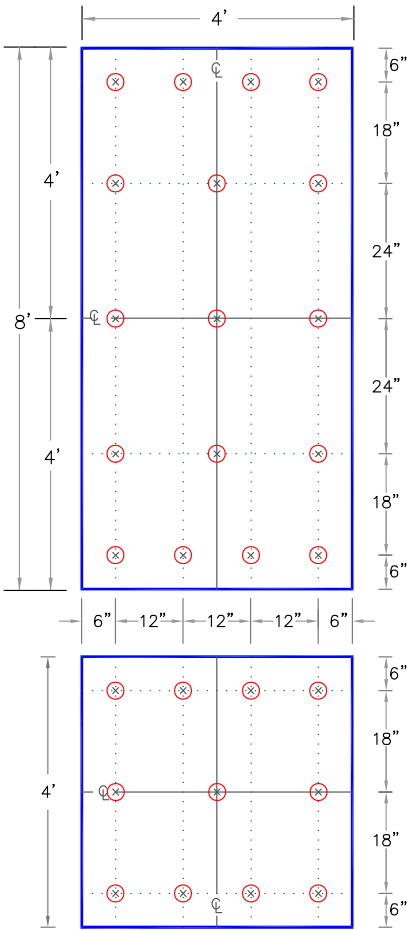

NOTES:

1. WHEN ENHANCED FASTENING IS REQUIRED AS PRESCRIBED IN FACTORY MUTUAL LOSS PREVENTION DATA SHEET 1-29, ANSI/SPRI WD-1 OR MIAMI-DADE COUNTY, REFER TO [CARLISLE'S DESIGN REFERENCE DR-05-18](#).
2. FOR CRITERIA ON INSULATION FASTENERS AND PLATES, REFER TO CARLISLE SPECIFICATIONS.
3. IF A WIND SPEED WARRANTY GREATER THAN 55 MILES PER HOUR (25 METERS PER SECOND) OR A WARRANTY TERM GREATER THAN 20-YEARS IS SPECIFIED OR FOR SYSTEMS OVER 50'(15METERS), ADDITIONAL FASTENING MAY BE REQUIRED, REFER TO CARLISLE SPECIFICATIONS.
4. OSB (ORIENTED STRAND BOARD) MUST BE POSITIONED WITH AN 1/8" (0.5m) GAP BETWEEN BOARDS.
5. WHEN SPECIFIED, JOINTS IN OSB (ORIENTED STRAND BOARD) MUST BE STAGGERED WITH JOINTS IN INSULATION BELOW.

FEET TO CENTIMETERS		INCHES TO CENTIMETERS																				
4'	8'	inch	1/8"	1/4"	5/32"	1/2"	5/8"	3/4"	1"	1.5"	2"	2.5"	3"	4"	6"	8"	9"	11"	12"	18"	24"	36"
120	250	cm	0.5	1	1.2	1.5	1.6	2	2.5	4	5	6.5	7.5	10	15	20	23	28	30	46	61	91

<p> FASTENER & PLATE CENTER LINE GUIDE LINE </p>	<p>OSB SHEATHING ATTACHMENT</p> <p>For additional information, refer to Specifications</p>		DETAIL NO. <p style="font-size: 24pt;">A-27F</p> ADHERED SYSTEM
	<p>© 2023 Carlisle SynTec a division of Carlisle Construction Materials Incorporated</p>		

ATTACHMENT DETAILS INSULATION/ COVER BOARD

NOTES:

- REFER TO CARLISLE SPECIFICATIONS FOR PRODUCT DATA SHEETS FOR APPROPRIATE BEAD SPACING BASED UPON THE BUILDING HEIGHT, WARRANTY TERM AND ACCEPTABLE SUBSTRATE.
- THE SURFACE TO WHICH ADHESIVE IS TO BE APPLIED SHALL BE DRY, FREE OF FINES, PROTRUSIONS, SHARP EDGES, LOOSE AND FOREIGN MATERIALS, OIL AND GREASE. AREA SHOULD BE CLEANED WITH AN AIR BLOWER.
- PREVIOUSLY UNEXPOSED ASPHALT OR RESIDUE MUST BE PRIMED WITH CARLISLE CAVGRIP III, 702 OR 702LV PRIMER.
- SEAL ALL GAPS IN THE CONCRETE DECK WITH CARLISLE 725TR OR OTHER SUITABLE MATERIAL TO AVOID CONDENSATION ISSUES OR FILL WITH CARLISLE INSULATION ADHESIVE.
- AT THE BEGINNING OF THE INSULATION ATTACHMENT PROCESS AND PERIODICALLY THROUGHOUT THE DAY, CHECK THE ADHESION OF BOARDS TO ENSURE A TIGHT BOND IS CREATED AND MAXIMUM CONTACT IS ACHIEVED.
- WALK THE BOARDS INTO THE ADHESIVE AND ROLL USING A 30" WIDE, 150 POUND SEGMENTED STEEL ROLLER TO ENSURE FULL EMBEDMENT.
- ONE PERSON SHOULD BE DESIGNATED TO WALK AND ROLL IN ALL BOARDS. RELIEF CUTS MAY BE NECESSARY TO ALLOW LIFTED BOARD TO LAY FLAT, OR CONSTANT WEIGHT (10LBS MINIMUM FOR 5-15 MINUTES PER LIFTED AREA) MAY BE NECESSARY TO ACHIEVE ADEQUATE ADHESION.

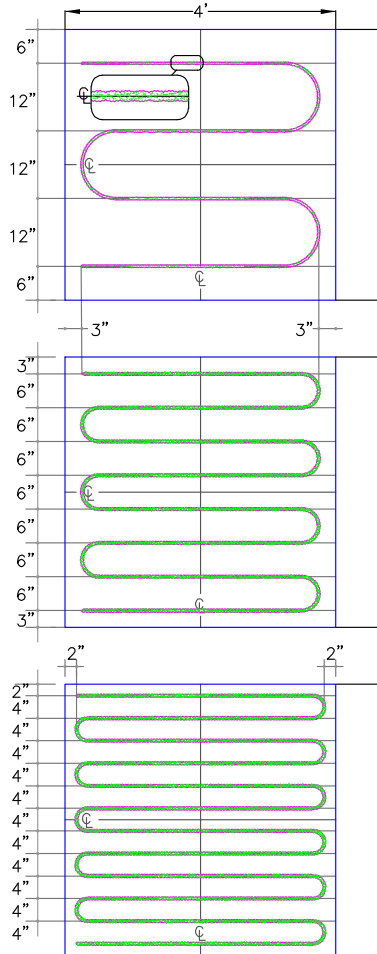

FEET TO CENTIMETERS	
4'	8'
120	250

		INCHES TO CENTIMETERS																			
inch		1/8"	1/4"	5/32"	1/2"	5/8"	3/4"	1"	1.5"	2"	2.5"	3"	4"	6"	8"	9"	11"	12"	18"	24"	36"
cm		0.5	1	1.2	1.5	1.6	2	2.5	4	5	6.5	7.5	10	15	20	23	28	30	46	61	91

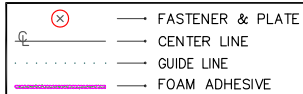

INSULATION/COVER BOARD ATTACHMENT USING BEAD ADHESIVE
 For additional information, refer to Specifications



DETAIL NO. A-27G
 ADHERED SYSTEM

ATTACHMENT DETAILS

INSULATION/ COVER BOARD

NEW CONSTRUCTION OR RE-ROOF/TEAR OFF PROJECTS WITH SECUROCK, DENS-DECK, HP RECOVERY BROAD OR ANY CARLISLE APPROVED INSULATION MIN 1-1/2" (40mm) THICK

RE-ROOF/NO TEAR OFF PROJECTS WITH POLYISOCYANURATE LESS THAN 1-1/2" (40mm) THICK

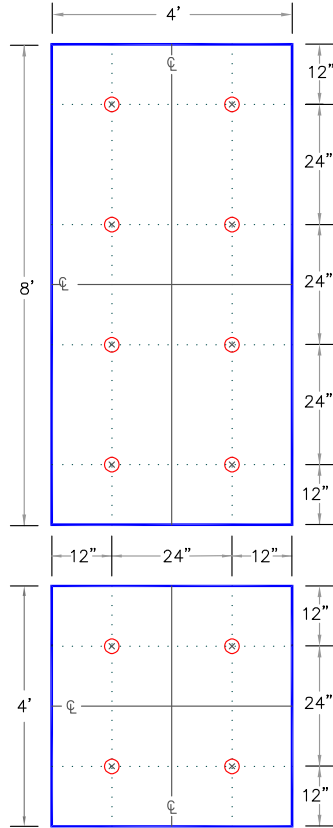
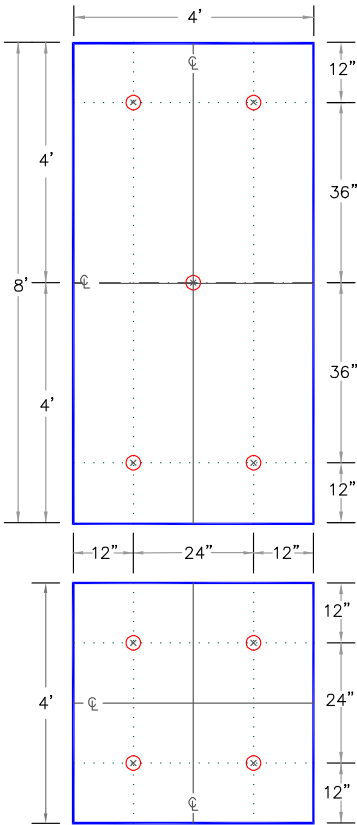

NOTES:

1. FOR CRITERIA ON INSULATION FASTENERS AND PLATES, REFER TO CARLISLE SPECIFICATIONS.
2. 25 AND 30-YEAR WARRANTY PROJECTS REQUIRE COMPLETE TEAR OFF.

FEET TO CENTIMETERS		INCHES TO CENTIMETERS																				
4'	8'	inch	1/8"	1/4"	5/32"	1/2"	5/8"	3/4"	1"	1.5"	2"	2.5"	3"	4"	6"	8"	9"	11"	12"	18"	24"	36"
120	250	cm	0.5	1	1.2	1.5	1.6	2	2.5	4	5	6.5	7.5	10	15	20	23	28	30	46	61	91

FASTENER & PLATE CENTER LINE GUIDE LINE FOAM ADHESIVE	INSULATION/COVER BOARD ATTACHMENT FOR ALL WARRANTY DURATIONS For additional information, refer to Specifications	DETAIL NO. MF-27 MECHANICALLY FASTENED

ATTACHMENT DETAILS INSULATION/ COVER BOARD

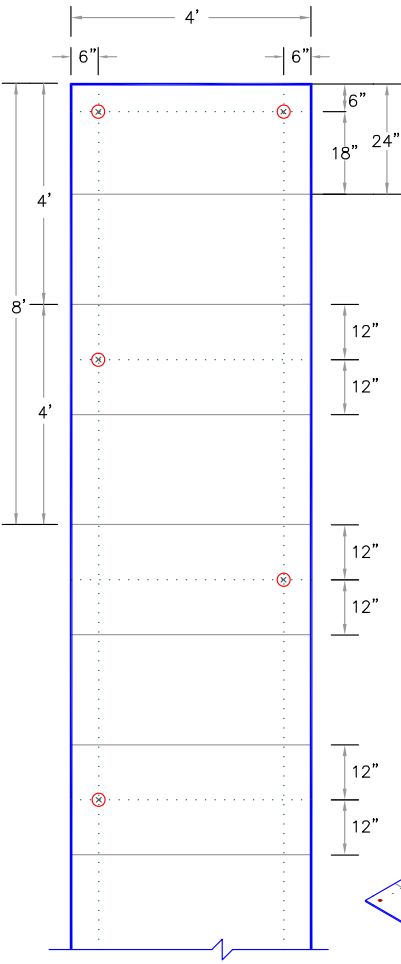

NOTES:

1. INSTALL R-TECH RECOVER BOARD WITH CONTINUOUS SIDE JOINTS AND END JOINTS STAGGERED SO THEY ARE OFFSET BY A MINIMUM OF 12" (30cm) FROM THE END JOINTS IN ADJACENT ROWS.
2. INSULATION SHOULD ABUT TIGHTLY AGAINST ADJACENT BOARDS.
3. IF R-TECH FANFOLD RECOVER BOARD IS BEING INSTALLED OVER AN EXISTING LAYER OF INSULATION, ALL JOINTS MUST BE OFFSET A MINIMUM OF 6" (15cm) BETWEEN LAYERS.
4. FASTENERS SHOULD NEVER BE CLOSER THAN 6" (15cm) FROM THE EDGES OF THE BOARD.
5. CARE MUST BE TAKEN TO AVOID OVERDRIVING OR UNDER-DRIVING THE FASTENER AND PLATE ASSEMBLY.
6. METALLIC FACER PERMITS THE USE OF R-TECH RECOVER BOARD UNDER EPDM MECHANICALLY FASTENED ASSEMBLIES IN NORTHERN CLIMATES (CONTACT CARLISLE FOR ACCEPTANCE).

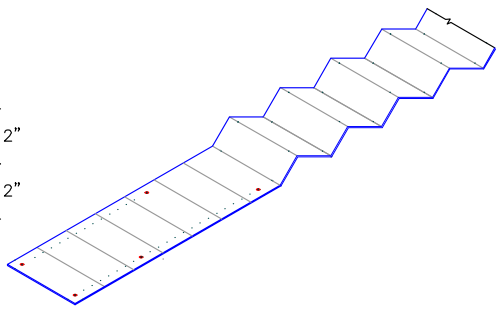

FEET TO CENTIMETERS		INCHES TO CENTIMETERS																				
4'	8'	inch	1/8"	1/4"	15/32"	1/2"	5/8"	3/4"	1"	1.5"	2"	2.5"	3"	4"	6"	8"	9"	11"	12"	18"	24"	36"
120	250	cm	0.5	1	1.2	1.5	1.6	2	2.5	4	5	6.5	7.5	10	15	20	23	28	30	46	61	91

	FASTENER & PLATE CENTER LINE GUIDE LINE FOAM ADHESIVE	R-Tech FANFOLD ROOF UNDERLAYMENT For additional information, refer to Specifications	DETAIL NO. MF-27C MECHANICALLY FASTENED
--	--	---	--

ATTACHMENT DETAILS INSULATION / COVER BOARD

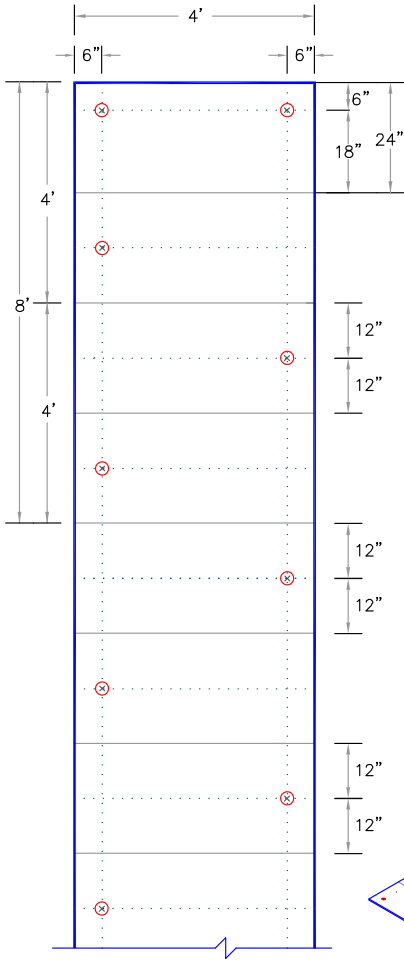

NOTES:

1. INSTALL R-TECH RECOVER BOARD WITH CONTINUOUS SIDE JOINTS AND END JOINTS STAGGERED SO THEY ARE OFFSET BY A MINIMUM OF 12" (30cm) FROM THE END JOINTS IN ADJACENT ROWS.
2. INSULATION SHOULD ABUT TIGHTLY AGAINST ADJACENT BOARDS.
3. IF R-TECH FANFOLD RECOVER BOARD IS BEING INSTALLED OVER AN EXISTING LAYER OF INSULATION, ALL JOINTS MUST BE OFFSET A MINIMUM OF 6" (15cm) BETWEEN LAYERS.
4. FASTENERS SHOULD NEVER BE CLOSER THAN 6" (15cm) FROM THE EDGES OF THE BOARD.
5. CARE MUST BE TAKEN TO AVOID OVERDRIVING OR UNDER-DRIVING THE FASTENER AND PLATE ASSEMBLY.
6. METALLIC FACER PERMITS THE USE OF R-TECH RECOVER BOARD UNDER EPDM MECHANICALLY FASTENED ASSEMBLIES IN NORTHERN CLIMATES (CONTACT CARLISLE FOR ACCEPTANCE).
7. FOR NON-FM ASSEMBLY REFER TO DETAIL MF-27C

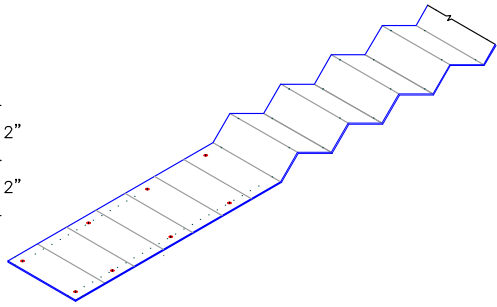

FEET TO CENTIMETERS		INCHES TO CENTIMETERS																				
4'	8'	inch	1/8"	1/4"	5/32"	1/2"	5/8"	3/4"	1"	1.5"	2"	2.5"	3"	4"	6"	8"	9"	11"	12"	18"	24"	36"
120	250	cm	0.5	1	1.2	1.5	1.6	2	2.5	4	5	6.5	7.5	10	15	20	23	28	30	46	61	91
FASTENER & PLATE CENTER LINE GUIDE LINE FOAM ADHESIVE		R-Tech FANFOLD ROOF UNDERLAYMENT FOR FM ASSEMBLIES For additional information, refer to Specifications															DETAIL NO. MF-27D MECHANICALLY FASTENED					

ATTACHMENT DETAILS INSULATION/ COVER BOARD

NEW CONSTRUCTION OR RE-ROOF/TEAR OFF PROJECTS WITH 1/2" SecurShield HD COATED GLASS FACER

NEW CONSTRUCTION OR RE-ROOF/TEAR OFF PROJECTS WITH 20 OR 25 PSI SecurShield ANY THICKNESS

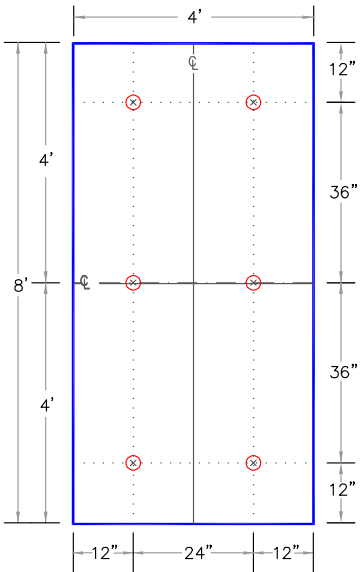
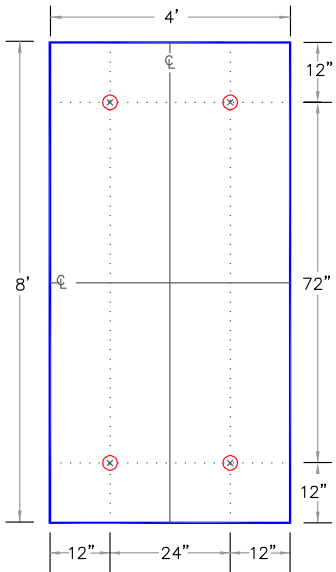

FEET TO CENTIMETERS		INCHES TO CENTIMETERS																				
4'	8'	inch	1/8"	1/4"	5/32"	1/2"	5/8"	3/4"	1"	1.5"	2"	2.5"	3"	4"	6"	8"	9"	11"	12"	18"	24"	36"
120	250	cm	0.5	1	1.2	1.5	1.6	2	2.5	4	5	6.5	7.5	10	15	20	23	28	30	46	61	91

FASTENER & PLATE CENTER LINE GUIDE LINE FOAM ADHESIVE	INSULATION/COVERBOARD ATTACHMENT WHEN USING SecurShield FAMILY PRODUCTS FOR ALL WARRANTIES LENGTHS		DETAIL NO.
	For additional information, refer to Specifications		MF-27E

© 2023 Carlisle SynTec a division of Carlisle Construction Materials Incorporated

THERMOPLASTIC MEMBRANE PVC/TPO

GUIDELINES FOR ROOF PERIMETER ZONES FOR MECHANICALLY ATTACHED ROOF SYSTEM

 PERIMETER ZONES

SPLIT LEVEL ROOFS
 GREATER THAN 10 FT (3m)

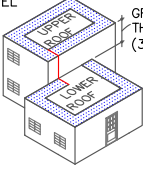

SPLIT LEVEL ROOFS
 LESS THAN 10 FT (3m)

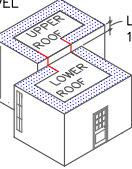

CANOPY ROOF
 INSTALL PERIMETER SHEETS OVER THE ENTIRE OVERHANG (PROJECTION ROOF) AREA, EXTENDING ONTO THE MAIN ROOF DECK WHEN AT THE SAME LEVEL AS SHOWN.

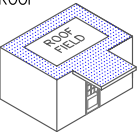

LARGE OPENINGS OR LOADING DOCKS

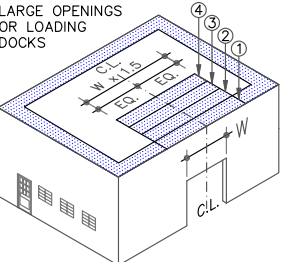

4 PERIMETER SHEETS CENTERED OVER LARGE OPENINGS

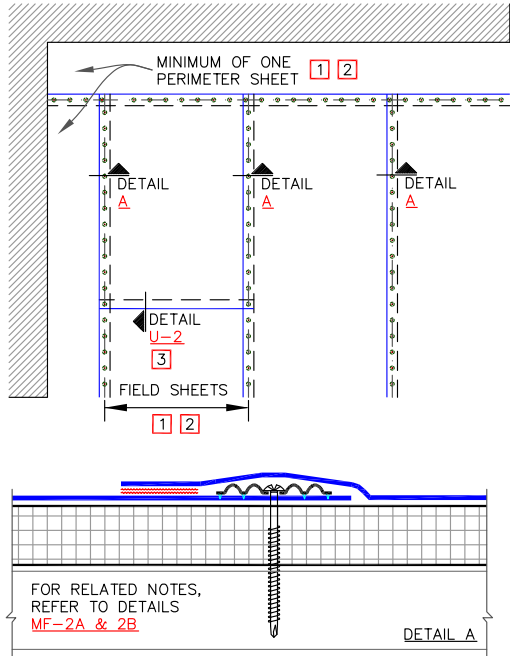

NOTES:

1. WHEN USING 10' (3m) OR 12' (3.7m) WIDE TPO FIELD SHEETS, 6' (1.8m) WIDE PERIMETER SHEETS ARE UTILIZED. WHEN USING 8' (2.4m) WIDE TPO FIELD SHEETS, 4' (1.2m) WIDE PERIMETER SHEETS ARE USED. WHEN USING 10' (3m) WIDE PVC FIELD SHEETS, 5' (1.5m) WIDE PERIMETER SHEETS ARE UTILIZED. WHEN USING 81" (2.1m) WIDE PVC FIELD SHEETS, 40.5" (1m) WIDE PERIMETER SHEETS ARE USED.
2. REFER TO CARLISLE SPECIFICATIONS FOR REQUIRED NUMBER OF PERIMETER SHEETS, SHEET WIDTH AND MEMBRANE FASTENING DENSITY.
3. END LAPS DO NOT REQUIRE MECHANICAL FASTENING AND SHALL BE OVERLAPPED 2" (5cm) MINIMUM. REFER TO THERMOPLASTIC [DETAIL U-2](#).

	MEMBRANE SECUREMENT		DETAIL NO.
	MAXIMUM WARRANTY: 30 YEARS		MF-2
		THERMOPLASTIC UNIVERSAL	

THERMOPLASTIC MEMBRANE

TPO

GUIDELINES FOR ROOF PERIMETER ZONES FOR MECHANICALLY ATTACHED ROOF SYSTEM

PERIMETER ZONES

SPLIT LEVEL ROOFS
 GREATER THAN 10 FT (3m)

SPLIT LEVEL ROOFS
 LESS THAN 10 FT (3m)

CANOPY ROOF
 INSTALL PERIMETER SHEETS OVER THE ENTIRE OVERHANG (PROJECTION ROOF) AREA, EXTENDING ONTO THE MAIN ROOF DECK WHEN AT THE SAME LEVEL AS SHOWN.

LARGE OPENINGS OR LOADING DOCKS
 4 PERIMETER SHEETS CENTERED OVER LARGE OPENINGS

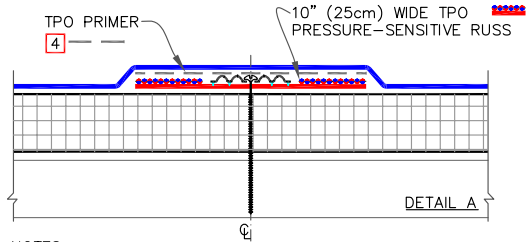
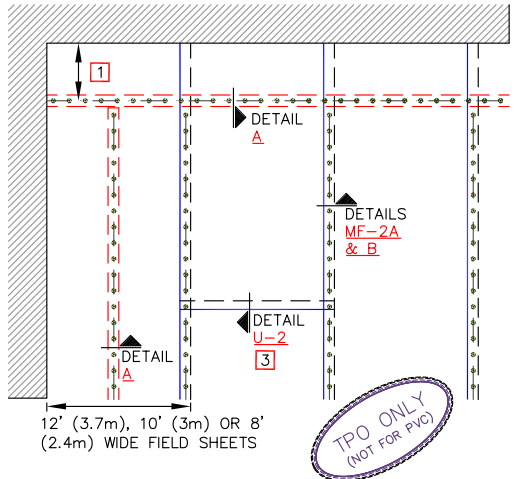

NOTES:

1. PRESSURE-SENSITIVE RUS SHALL BE POSITIONED 5' (1.5m) TO 6' (1.8m) FROM THE PERIMETER EDGE WHEN USING 10' (3m) OR 12' (3.7m) WIDE TPO FIELD SHEETS. WHEN USING 8' (2.4m) WIDE TPO FIELD SHEETS, PRESSURE-SENSITIVE RUS SHALL BE POSITIONED 4' (1.2m) FROM THE PERIMETER EDGE.
2. REFER TO CARLISLE SPECIFICATIONS FOR REQUIRED NUMBER OF PERIMETER SHEETS, SHEET WIDTH AND MEMBRANE FASTENING DENSITY.
3. END LAPS DO NOT REQUIRE MECHANICAL FASTENING AND SHALL BE OVERLAPPED 2" (5cm) MINIMUM. REFER TO THERMOPLASTIC **DETAIL U-2**.
4. TPO PRIMER MUST BE APPLIED TO THE BACK SIDE OF MEMBRANE SURFACE PRIOR TO ADHERING MEMBRANE TO PRESSURE-SENSITIVE RUS.

	TPO MEMBRANE SECUREMENT WITH PRESSURE-SENSITIVE RUS		DETAIL NO.
	MAXIMUM WARRANTY: 30 YEARS		MF-2.1
		THERMOPLASTIC TPO	

■ THERMOPLASTIC MEMBRANE ■ PVC/TPO ■

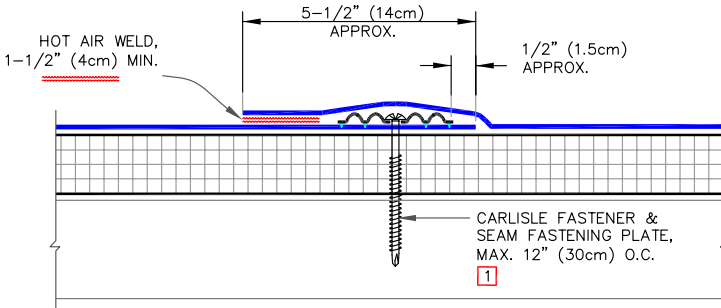

T-JOINT REQUIREMENTS

MEMBRANE	THICKNESS		
	45/50	60	80
PVC	N/A	N/A	YES
KEE HP	N/A	N/A	YES
TPO	N/A	YES	YES

NOTES:

- ON MECHANICALLY FASTENED SYSTEMS, HP-X FASTENERS AND PIRANHA PLATES OR HP-XTRA FASTENERS AND PIRANHA XTRA PLATES ARE REQUIRED OVER STEEL AND WOOD DECKS. ON CONCRETE DECKS, CD-10 OR HD 14-10 FASTENERS ARE USED WITH PIRANHA PLATES.
- POSITION SEAM FASTENING PLATES BEYOND NON-REINFORCED ENCAPSULATED EDGE.
- APPROXIMATELY 1/8" (0.5cm) DIAMETER BEAD OF CUT-EDGE SEALANT IS REQUIRED ON CUT EDGES OF REINFORCED TPO MEMBRANE.

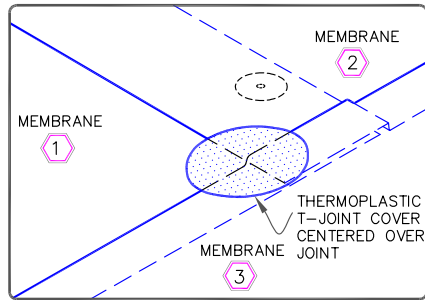

	MECHANICALLY FASTENED MEMBRANE SPLICE		DETAIL NO.
	MAXIMUM WARRANTY: 30 YEARS		MF-2A
		THERMOPLASTIC UNIVERSAL	

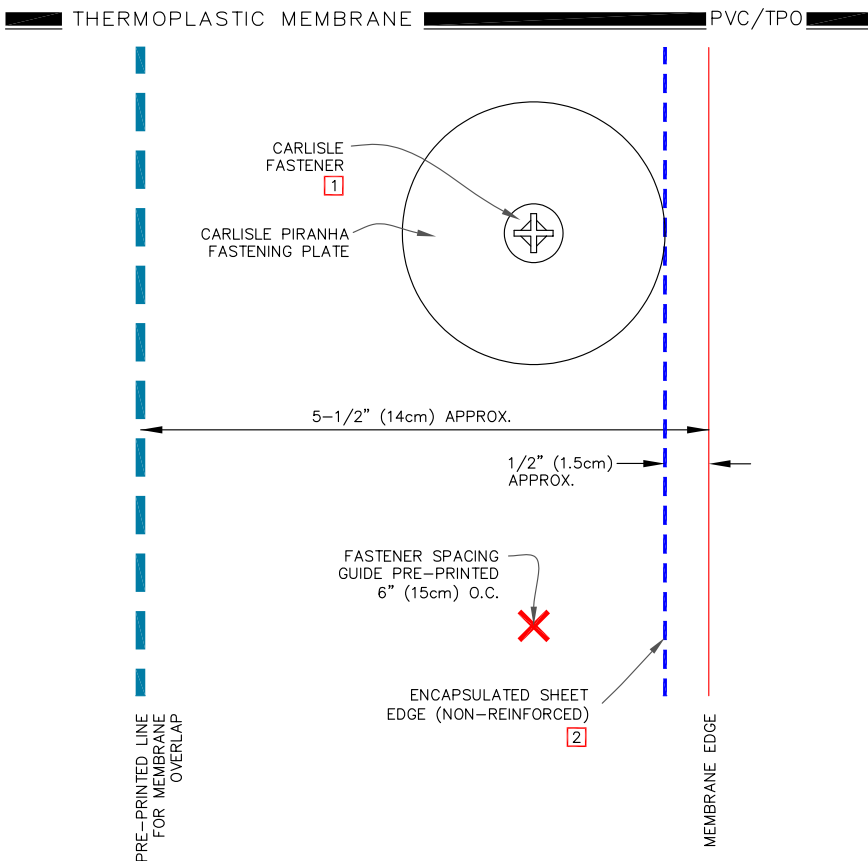

NOTES:

1. ON MECHANICALLY FASTENED SYSTEMS, HP-X FASTENERS AND PIRANHA PLATES OR HP-XTRA FASTENERS AND PIRANHA XTRA PLATES ARE REQUIRED OVER STEEL AND WOOD DECKS. ON CONCRETE DECKS, CD-10 OR HD 14-10 FASTENERS ARE USED WITH PIRANHA PLATES.
2. POSITION SEAM FASTENING PLATES BEYOND NON-REINFORCED ENCAPSULATED EDGE.

	FASTENER AND PLATE PLACEMENT		DETAIL NO.
	MAXIMUM WARRANTY: 30 YEARS		MF-2B
		THERMOPLASTIC UNIVERSAL	

© 2023 Carlisle SynTec a division of Carlisle Construction Materials Incorporated

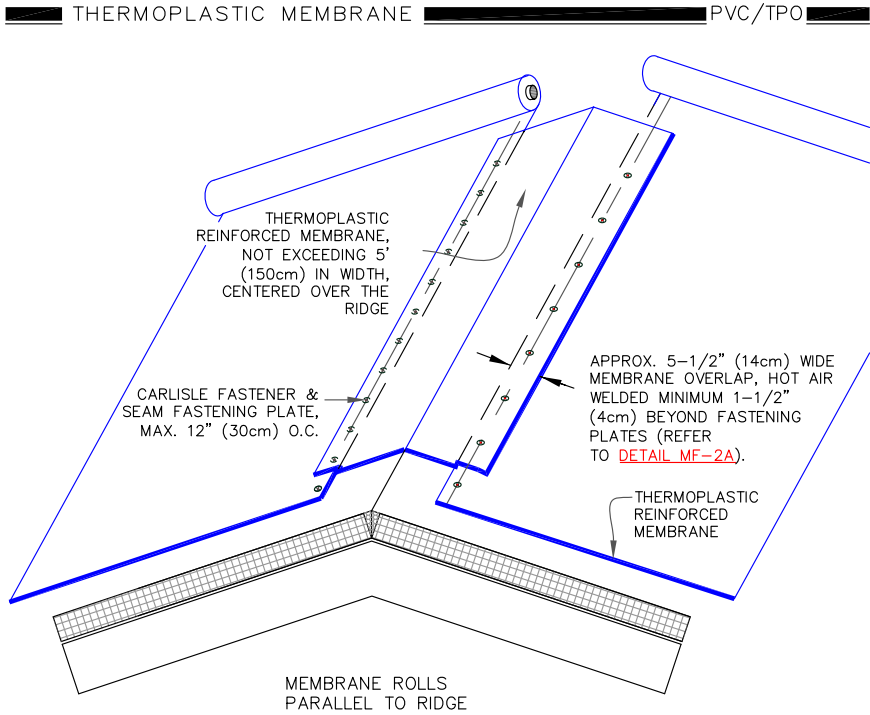

NOTES

1. RIDGE MEMBRANE ATTACHMENT IS ONLY REQUIRED WHEN ROOF SLOPE EXCEEDS 3" (7.5cm) TO ONE HORIZONTAL FOOT.
2. POSITION FASTENING PLATES 1/2" (1.5cm) MINIMUM TO 1" (2.5cm) MAXIMUM FROM THE EDGE OF THE DECK MEMBRANE.
3. APPROXIMATELY 1/8" (0.5cm) DIAMETER BEAD OF CUT-EDGE SEALANT IS REQUIRED ON CUT EDGES OF REINFORCED TPO MEMBRANE.
4. REFER TO CARLISLE SPECIFICATIONS FOR REQUIRED NUMBER OF PERIMETER SHEETS, SHEET WIDTH AND MEMBRANE FASTENING DENSITY.
5. ON MECHANICALLY FASTENED SYSTEMS, HP-X FASTENERS AND PIRANHA PLATES OR HP-XTRA FASTENERS AND PIRANHA XTRA PLATES ARE REQUIRED OVER STEEL AND WOOD DECKS. ON CONCRETE DECKS, CD-10 OR HD 14-10 FASTENERS ARE USED WITH PIRANHA PLATES.
6. AS AN OPTION TO USING PERIMETER SHEETS, 10" (25cm) WIDE TPO PRESSURE-SENSITIVE RUSS MAY BE USED BENEATH TPO FIELD SHEETS ONLY FOR PERIMETER SECUREMENT.

	RIDGE MEMBRANE ATTACHMENT		DETAIL NO.
	MAXIMUM WARRANTY: 30 YEARS		MF-22
		THERMOPLASTIC UNIVERSAL	

© 2023 Carlisle SynTec a division of Carlisle Construction Materials Incorporated

THERMOPLASTIC MEMBRANE

TPO

CAUTION

DETAIL NOT FOR USE ON 25 OR 30-YEAR WARRANTY PROJECTS. ACCEPTABLE EDGING SHALL CONFORM WITH THERMOPLASTIC UNIVERSAL DETAILS [U-1B](#), [U-1C](#), [U-1D](#), [U-1E](#) OR [U-1F](#).

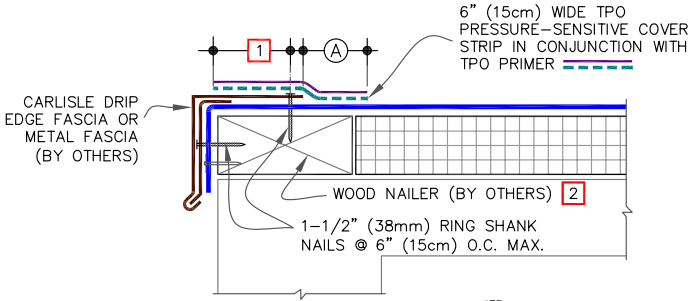

NOTES:

- METAL FASCIA DECK FLANGE MUST BE TOTALLY COVERED BY TPO PRESSURE-SENSITIVE COVER STRIP WITH MINIMUM 2" (5cm) COVERAGE PAST NAIL HEADS.
- WOOD NAILER MUST EXTEND PAST TOTAL WIDTH OF METAL FASCIA DECK FLANGE.
- TO REMOVE FINISHING OILS, SCRUB METAL FLANGE WITH WEATHERED MEMBRANE CLEANER; ALLOW TO DRY PRIOR TO APPLYING TPO PRIMER.
- APPLY TPO PRIMER TO METAL FLANGE AND MEMBRANE SURFACE PRIOR TO INSTALLING TPO PRESSURE-SENSITIVE COVER STRIP.
- WHEN METAL FASCIA BY OTHERS IS USED, FASTENER TYPE AND FASTENING FREQUENCY SHALL BE RECOMMENDED BY METAL EDGE MANUFACTURER.
- TO ENSURE TPO PRESSURE-SENSITIVE COVER STRIP CONFORMS TO STEP-OFFS, HEAT COVER STRIP AT SPLICE INTERSECTIONS PRIOR TO ROLLING.
- THIS DETAIL IS NOT RECOMMENDED FOR ROOFS THAT ARE LIKELY TO EXPERIENCE SIGNIFICANT SNOW AND ICE UP-SLOPE FROM THE GUTTER /EDGE. REFER TO DETAILS [U-1B](#) OR [U-1C](#).

TPO ONLY
(NOT FOR PVC)

DIMENSIONS		cm	
(A)	2"	5	MIN.
(B)	1/2"	1.5	TO
	1"	2.5	

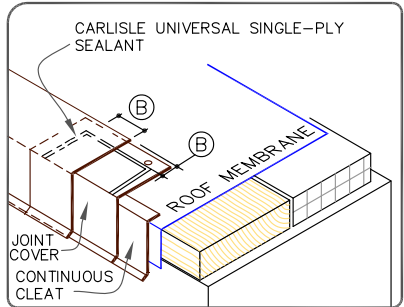

	SecurSeal DRIP EDGE FASCIA		DETAIL NO.
	MAXIMUM WARRANTY: 20 YEARS		U-1A
		THERMOPLASTIC TPO	

© 2023 Carlisle SynTec a division of Carlisle Construction Materials Incorporated

THERMOPLASTIC MEMBRANE

PVC/TPO

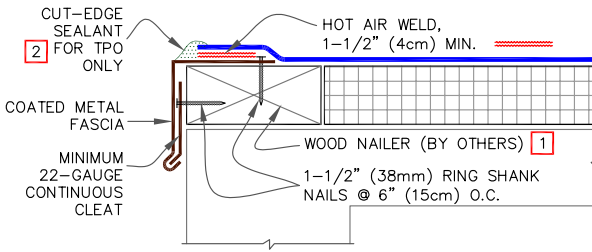

NOTES:

1. WOOD NAILER MUST EXTEND PAST TOTAL WIDTH OF METAL FASCIA DECK FLANGE.
2. APPROXIMATELY 1/8" (0.5cm) DIAMETER BEAD OF CUT-EDGE SEALANT IS REQUIRED ON CUT EDGES OF REINFORCED TPO MEMBRANE.

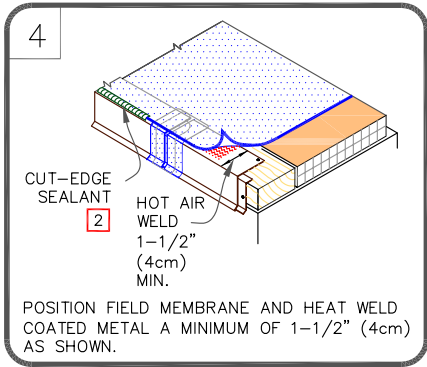
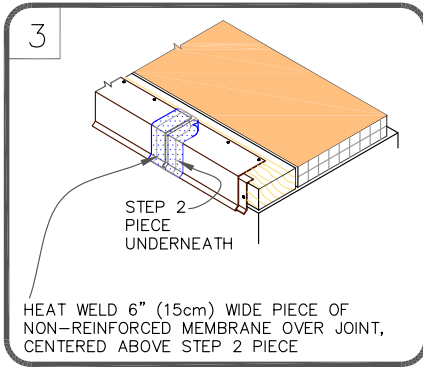
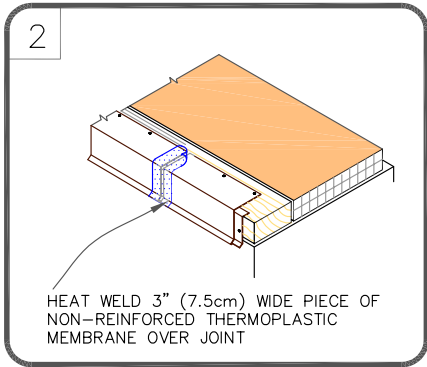
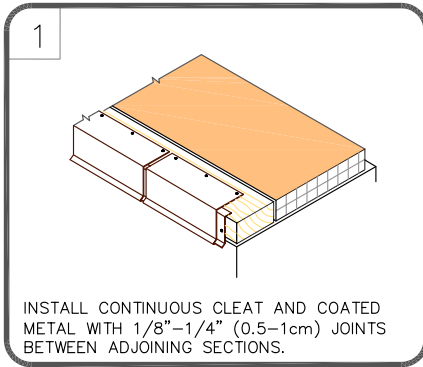

	SecurWELD COATED DRIP EDGE FASCIA		DETAIL NO.
	MAXIMUM WARRANTY: 30 YEARS		U-1B
		THERMOPLASTIC UNIVERSAL	

■■■■ THERMOPLASTIC MEMBRANE ■■■■ PVC/TPO ■■■■

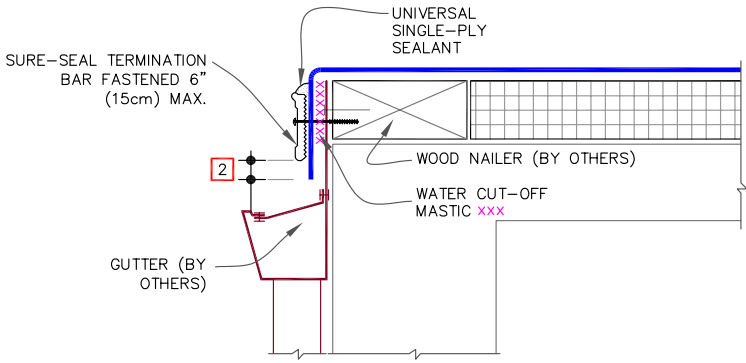

NOTES:

1. FASTENING OF METAL TERMINATION BAR MUST PROVIDE CONSTANT COMPRESSION ON WATER CUT-OFF MASTIC.
2. ALLOW MEMBRANE SHEET TO EXTEND 1/2" (1.5cm) MINIMUM BELOW THE METAL TERMINATION BAR.

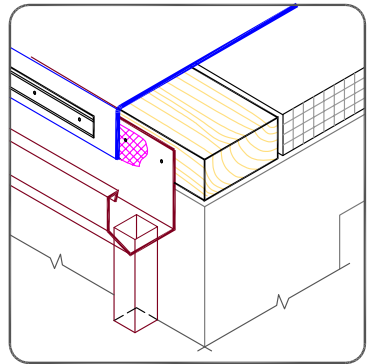

	METAL BAR EDGE TERMINATION		DETAIL NO.
	MAXIMUM WARRANTY: 30 YEARS		U-1C
		THERMOPLASTIC UNIVERSAL	

© 2023 Carlisle SynTec a division of Carlisle Construction Materials Incorporated

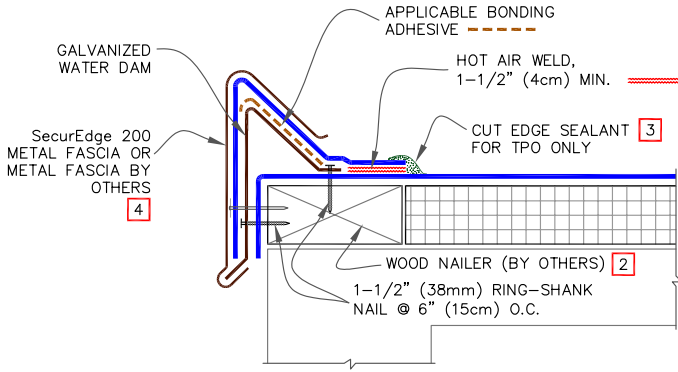

NOTES:

1. REFER TO [SecurEdge 200 INSTRUCTION MANUAL](#) FOR STEP-BY-STEP INSTALLATION PROCEDURES.
2. WOOD NAILER MUST EXTEND PAST TOTAL WIDTH OF SecurEdge DECK FLANGE.
3. APPROXIMATELY 1/8" (5mm) DIAMETER BEAD OF CUT-EDGE SEALANT IS REQUIRED ON CUT EDGES OF REINFORCED TPO MEMBRANE.
4. WHEN METAL FASCIA BY OTHERS IS USED, FASTENER TYPE AND FASTENING FREQUENCY SHALL BE RECOMMENDED BY METAL EDGE MANUFACTURER.

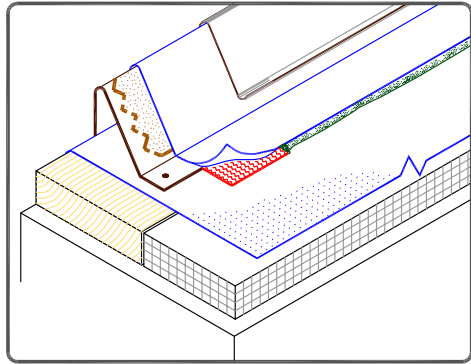

	CARLISLE SecurEdge 200		DETAIL NO.
	MAXIMUM WARRANTY: 30 YEARS		U-1D
		THERMOPLASTIC UNIVERSAL	

© 2023 Carlisle SynTec a division of Carlisle Construction Materials Incorporated

■■■■ THERMOPLASTIC MEMBRANE ■■■■ PVC/TPO ■■■■

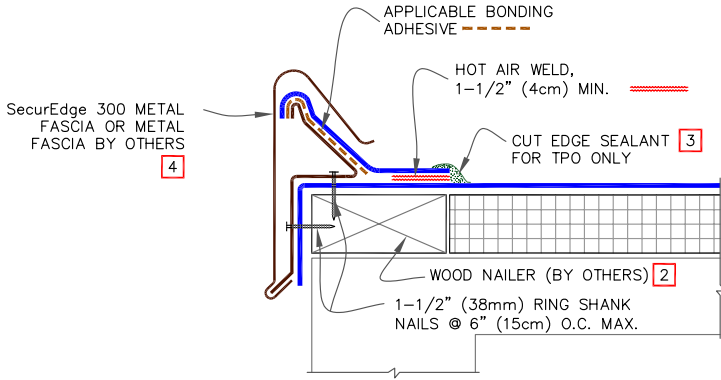

NOTES:

1. REFER TO [SecurEdge 300 INSTRUCTION MANUAL](#) FOR STEP-BY-STEP INSTALLATION PROCEDURES.
2. WOOD NAILER MUST EXTEND PAST TOTAL WIDTH OF SecurEdge DECK FLANGE.
3. APPROXIMATELY 1/8" (0.5cm) DIAMETER BEAD OF CUT-EDGE SEALANT IS REQUIRED ON CUT EDGES OF REINFORCED TPO MEMBRANE.
4. WHEN METAL FASCIA BY OTHERS IS USED, FASTENER TYPE AND FASTENING FREQUENCY SHALL BE RECOMMENDED BY METAL EDGE MANUFACTURER.

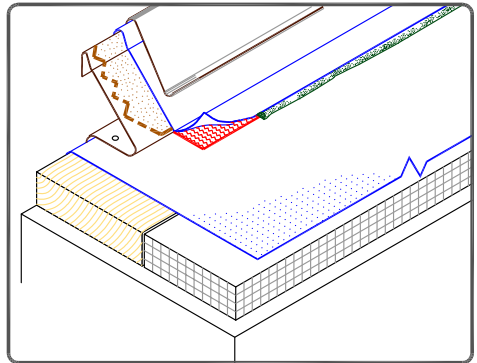

	CARLISLE SecurEdge 300		DETAIL NO.
	MAXIMUM WARRANTY: 30 YEARS		U-1E
		THERMOPLASTIC UNIVERSAL	

© 2023 Carlisle SynTec a division of Carlisle Construction Materials Incorporated

■ THERMOPLASTIC MEMBRANE ■ PVC/TPO ■

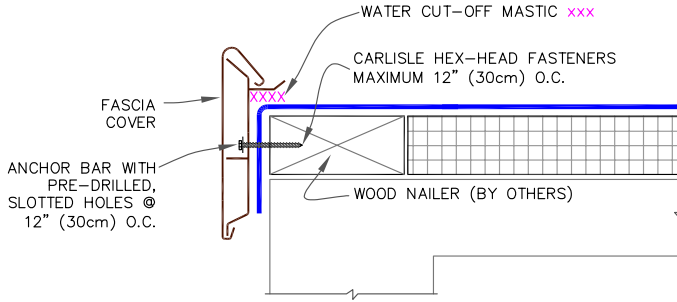

SecurEdge 2000

NOTES:

1. REFER TO SecurEdge INSTALLATION INSTRUCTION MANUAL FOR THE STEP BY STEP INSTALLATION PROCEDURES AND FOR THE VARIOUS PRODUCT FEATURES AVAILABLE.
2. IF INCIDENTAL/TEMPORARY PONDED WATER IS EXPECTED, THE SecurEdge MUST BE ELEVATED AND SCUPPERS PROVIDED FOR DRAINAGE.
3. ENSURE ROOF SLOPES AWAY FROM SecurEdge.

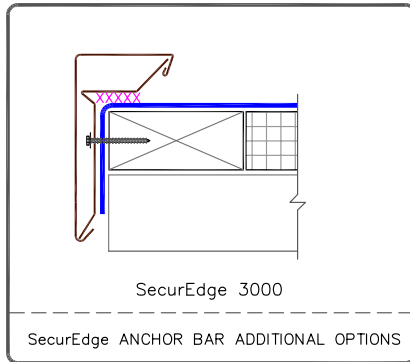

	CARLISLE SecurEdge 2000 & 3000		DETAIL NO.
	MAXIMUM WARRANTY: 30 YEARS		U-1F
		THERMOPLASTIC UNIVERSAL	

© 2023 Carlisle SynTec a division of Carlisle Construction Materials Incorporated

■ THERMOPLASTIC MEMBRANE ■ PVC/KEE HP ■

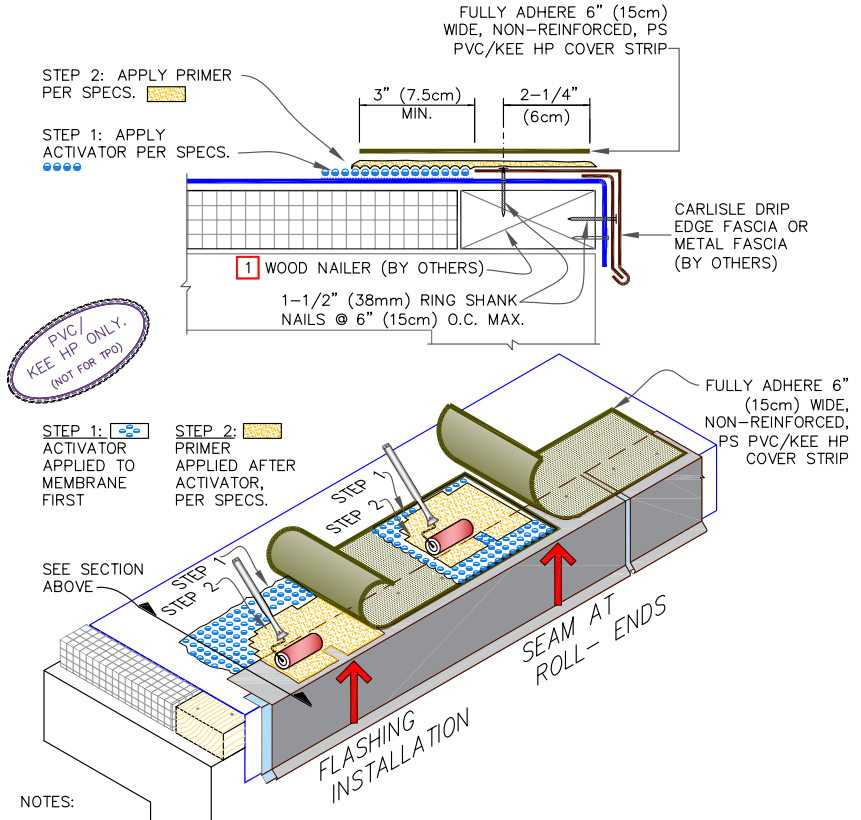

NOTES:

1. WOOD NAILER MUST EXTEND PAST TOTAL WIDTH OF METAL FASCIA DECK FLANGE.
2. TO REMOVE FINISHING OILS, SCRUB METAL FLANGE WITH PVC & KEE HP MEMBRANE CLEANER; ALLOW TO DRY PRIOR TO APPLYING PRIMER.
3. WHEN METAL FASCIA BY OTHERS IS USED, FASTENER TYPE AND FASTENING FREQUENCY SHALL BE RECOMMENDED BY METAL EDGE MANUFACTURER.
4. TO ENSURE PVC PRESSURE-SENSITIVE COVER STRIP CONFORMS TO STEP-OFFS, HEAT COVER STRIP AT SPLICE INTERSECTIONS PRIOR TO ROLLING.
5. THIS DETAIL IS NOT RECOMMENDED FOR ROOFS THAT ARE LIKELY TO EXPERIENCE SIGNIFICANT SNOW AND ICE. REFER TO COATED EDGE METAL DETAILS.

	PRESSURE-SENSITIVE PVC/KEE HP COVER STRIP		DETAIL NO.
	MAXIMUM WARRANTY: 20 YEARS		U-1G
		THERMOPLASTIC PVC	

© 2023 Carlisle SynTec a division of Carlisle Construction Materials Incorporated

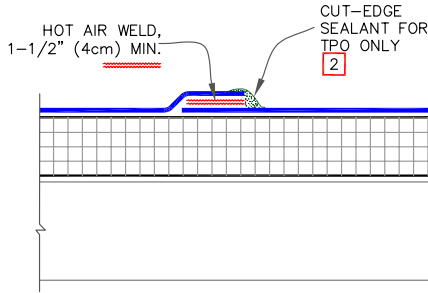

NOTES:

1. WHEN USING 60-MIL TPO OR 80-MIL TPO OR PVC MEMBRANE, APPLY A 4-1/2" (11.5cm) DIAMETER "T-JOINT" COVER AT ALL FIELD SPLICE INTERSECTIONS.
2. APPROXIMATELY 1/8" (0.5cm) DIAMETER BEAD OF CUT-EDGE SEALANT IS REQUIRED ON CUT EDGES OF REINFORCED TPO MEMBRANE.
3. WHEN USING 60-MIL TPO, MAXIMUM WARRANTY IS 20 YEARS

DIMENSIONS		cm	
(A)	2-1/4"	6	MIN.

T-JOINT REQUIREMENTS

MEMBRANE	THICKNESS		
	45/50	60	80
PVC	N/A	N/A	YES
KEE HP	N/A	N/A	YES
TPO	N/A	YES	YES

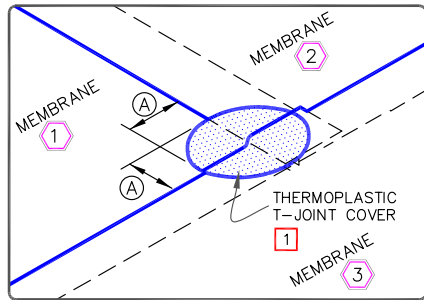

MEMBRANE SPLICE
MAXIMUM WARRANTY: 30 YEARS

	DETAIL NO.
	U-2A
THERMOPLASTIC UNIVERSAL	

THERMOPLASTIC MEMBRANE

TPO

MEMBRANE SPLICE

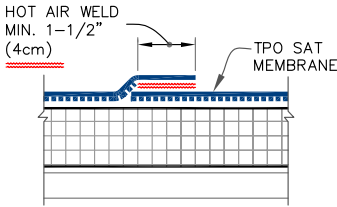

END LAP SPLICE

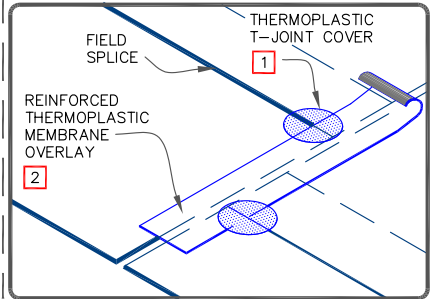
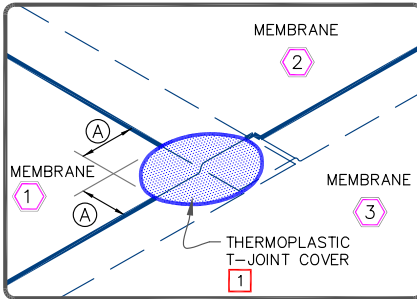
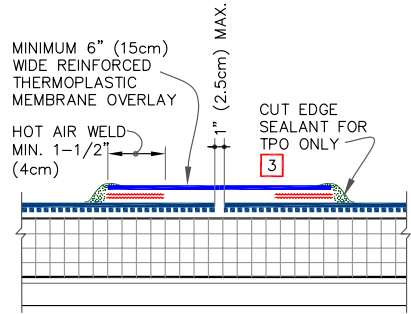

DIMENSION	cm
(A)	2-1/4" 6

NOTES:

1. WHEN USING 60 OR 80 MIL TPO SAT MEMBRANE, APPLY A 4-1/2" (11cm) DIAMETER THERMOPLASTIC "T-JOINT" COVER AT ALL FIELD SPLICE INTERSECTIONS.
2. WHEN USING 60 OR 80 MIL THERMOPLASTIC REINFORCED MEMBRANE OVERLAY, INTERSECTIONS BETWEEN SPLICES MUST BE OVERLAID WITH A 4-1/2" (11cm) DIAMETER THERMOPLASTIC "T-JOINT" COVER.
3. APPROXIMATELY 1/8" (0.5cm) DIAMETER BEAD OF CUT-EDGE SEALANT IS REQUIRED ON CUT EDGES OF REINFORCED TPO MEMBRANE.
4. WHEN USING 60-MIL TPO, MAXIMUM WARRANTY IS 20 YEARS

	THERMOPLASTIC MEMBRANE SPLICES		DETAIL NO.
	MAXIMUM WARRANTY: 30 YEARS		U-2B
		THERMOPLASTIC TPO	

© 2023 Carlisle SynTec a division of Carlisle Construction Materials Incorporated

■■■■ THERMOPLASTIC MEMBRANE ■■■■ PVC/TPO ■■■■

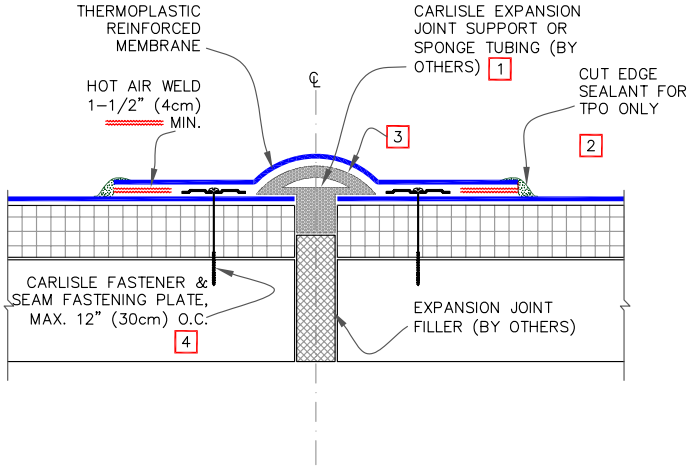

NOTES:

1. WHEN CARLISLE EXPANSION JOINT SUPPORT IS USED, WIDTH OF JOINT SHALL BE A MINIMUM OF 3/4" (2cm) AND SHALL NOT EXCEED 3" (7.5cm).
2. APPROXIMATELY 1/8" (0.5cm) DIAMETER BEAD OF CUT-EDGE SEALANT IS REQUIRED ON CUT EDGES OF REINFORCED TPO MEMBRANE.
3. MEMBRANE FLASHING SHALL NOT BE ADHERED OVER THE EXPANSION JOINT SUPPORT OR SPONGE TUBING.
4. ON MECHANICALLY FASTENED SYSTEMS, HP-X FASTENERS AND PIRANHA PLATES OR HP-XTRA FASTENERS AND PIRANHA XTRA PLATES ARE REQUIRED OVER STEEL AND WOOD DECKS. ON CONCRETE DECKS, CD-10 OR HD 14-10 FASTENERS ARE USED WITH PIRANHA PLATES.

	DECK-TO-DECK EXPANSION DETAIL		DETAIL NO.
	MAXIMUM WARRANTY: 30 YEARS		U-3A
		THERMOPLASTIC UNIVERSAL	

© 2023 Carlisle SynTec a division of Carlisle Construction Materials Incorporated

THERMOPLASTIC MEMBRANE

PVC/TPO

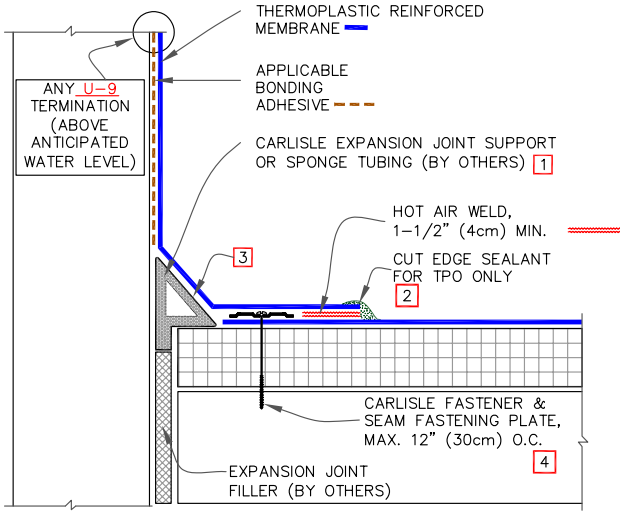

CAUTION

WHEN A WARRANTY WIND SPEED GREATER THAN 90MPH IS SPECIFIED, CARLISLE FASTENERS AND SEAM FASTENING PLATES SHALL NOT EXCEED 6" (15cm) ON CENTER FOR ADHERED MEMBRANE ASSEMBLIES.



NOTES:

1. WHEN CARLISLE EXPANSION JOINT SUPPORT IS USED, WIDTH OF JOINT SHALL BE A MINIMUM OF 3/4" (2cm) AND SHALL NOT EXCEED 2" (5cm).
2. APPROXIMATELY 1/8" (0.5cm) DIAMETER BEAD OF CUT-EDGE SEALANT IS REQUIRED ON CUT EDGES OF REINFORCED TPO MEMBRANE.
3. MEMBRANE FLASHING SHALL NOT BE ADHERED OVER THE EXPANSION JOINT SUPPORT OR SPONGE TUBING.
4. ON MECHANICALLY FASTENED SYSTEMS, HP-X FASTENERS AND PIRANHA PLATES OR HP-XTRA FASTENERS AND PIRANHA XTRA PLATES ARE REQUIRED OVER STEEL AND WOOD DECKS. ON CONCRETE DECKS, CD-10 OR HD 14-10 FASTENERS ARE USED WITH PIRANHA PLATES.

	DECK-TO-WALL EXPANSION DETAIL		DETAIL NO.
	MAXIMUM WARRANTY: 30 YEARS		U-3B
		THERMOPLASTIC UNIVERSAL	

© 2023 Carlisle SynTec a division of Carlisle Construction Materials Incorporated

THERMOPLASTIC MEMBRANE

PVC/TPO

NOTES:

1. WHEN USING TPO MEMBRANE, BONDING ADHESIVE IS NOT REQUIRED WHEN THE FLASHING HEIGHT IS 12" (30cm) OR LESS AND THE MEMBRANE IS FASTENED "AS SHOWN" ON TOP OF THE CURB. WHEN CARLISLE TERMINATION BAR IS USED BENEATH THE COUNTER-FLASHING, BONDING ADHESIVE CAN BE ELIMINATED WHEN THE MEMBRANE HEIGHT IS 18" (46cm) OR LESS.
2. APPLICABLE BONDING ADHESIVE FOR PVC OR TPO. IN CASE OF TPO, CAV-GRIP ADHESIVE MAY ALSO BE USED ON VERTICAL PORTION.
3. WHEN MECHANICAL FASTENERS ARE USED TO PENETRATE THE METAL COUNTER-FLASHING, USE EPDM WASHERS, APPLY WATER CUT-OFF MASTIC UNDER THE COUNTER-FLASHING OR CAULK THE FASTENER HEADS.
4. APPROXIMATELY 1/8" (0.5cm) DIAMETER BEAD OF CUT-EDGE SEALANT IS REQUIRED ON CUT EDGES OF REINFORCED TPO MEMBRANE.
5. REFER TO CARLISLE SPECIFICATIONS FOR ACCEPTABLE CARLISLE FASTENERS AND PLATES.
6. MECHANICAL SECUREMENT MAY BE INSTALLED INTO THE VERTICAL SUBSTRATE.
7. WHEN USING 60 MIL OR 80 MIL THICK CURB FLASHING, THE INTERSECTIONS BETWEEN SPLICES MUST OVERLAID WITH A THERMOPLASTIC "T-JOINT" COVER.

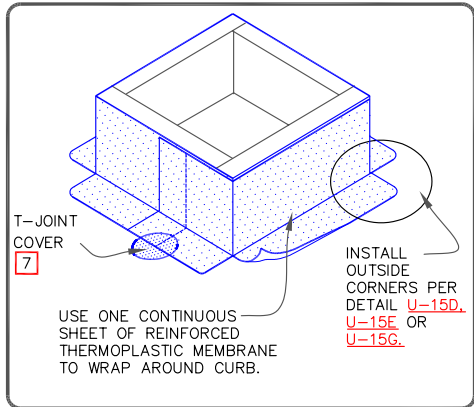
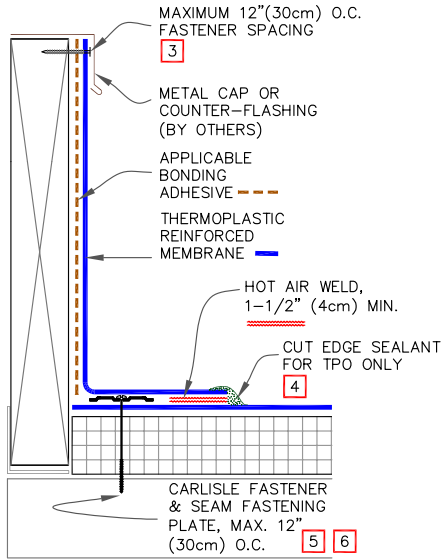

	CURB FLASHING WITH TPO OR PVC MEMBRANE		DETAIL NO.
	MAXIMUM WARRANTY: 30 YEARS		U-5A
		THERMOPLASTIC UNIVERSAL	

■■■■ THERMOPLASTIC MEMBRANE ■■■■ PVC/TPO ■■■■

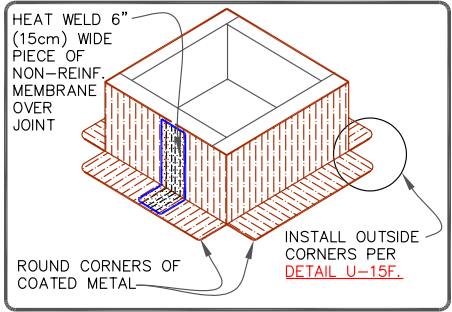
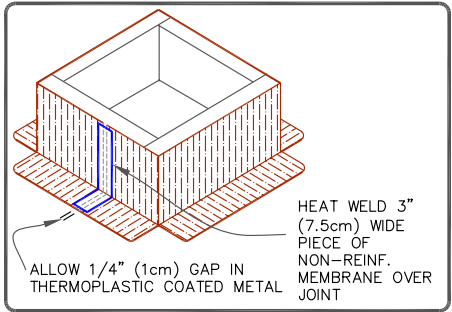
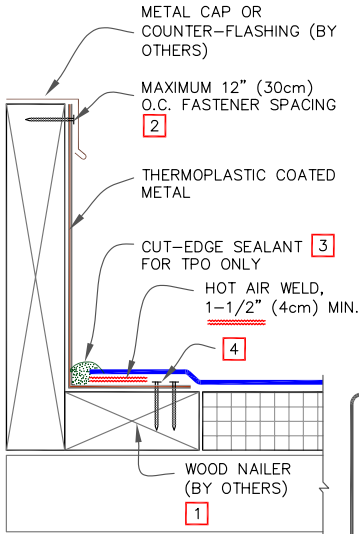

NOTES:

1. WOOD NAILER MUST EXTEND PAST TOTAL WIDTH OF COATED METAL DECK FLANGE.
2. WHEN MECHANICAL FASTENERS ARE USED TO PENETRATE THE METAL COUNTER-FLASHING, USE EPDM WASHERS, APPLY WATER CUT-OFF MASTIC UNDER COUNTER-FLASHING OR CAULK THE FASTENER HEAD.
3. APPROXIMATELY 1/8" (0.5cm) DIAMETER BEAD OF CUT-EDGE SEALANT IS REQUIRED ON CUT EDGES OF REINFORCED TPO MEMBRANE.
4. FASTEN COATED METAL USING 1-1/2" (38mm) MIN. RING SHANK NAILS AT 6" (15cm) STAGGERED APPROX. 1/2" (1.5cm).

	CURB FLASHING WITH TPO OR PVC COATED METAL		DETAIL NO.
	MAXIMUM WARRANTY: 30 YEARS		U-5B
		THERMOPLASTIC UNIVERSAL	

© 2023 Carlisle SynTec a division of Carlisle Construction Materials Incorporated

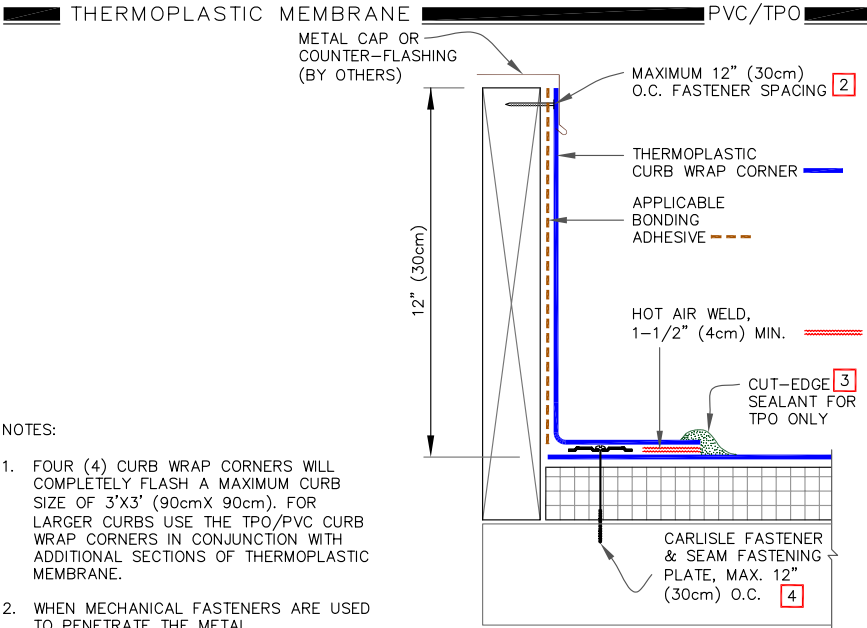

NOTES:

1. FOUR (4) CURB WRAP CORNERS WILL COMPLETELY FLASH A MAXIMUM CURB SIZE OF 3'X3' (90cmX 90cm). FOR LARGER CURBS USE THE TPO/PVC CURB WRAP CORNERS IN CONJUNCTION WITH ADDITIONAL SECTIONS OF THERMOPLASTIC MEMBRANE.
2. WHEN MECHANICAL FASTENERS ARE USED TO PENETRATE THE METAL COUNTER-FLASHING, USE EPDM WASHERS, APPLY WATER CUT-OFF MASTIC UNDER COUNTER-FLASHING OR CAULK FASTENER HEAD.
3. APPROXIMATELY 1/8" (0.5cm) BEAD OF CUT-EDGE SEALANT IS REQUIRED ON THE CUT EDGES OF THE TPO FIELD WRAP CORNER.
4. REFER TO CARLISLE SPECIFICATIONS FOR ACCEPTABLE CARLISLE FASTENERS AND PLATES.
5. CUSTOM SIZES ARE AVAILABLE FOR CURB FLASHING HEIGHTS GREATER THAN 12" (30cm).
6. APPLICABLE BONDING ADHESIVE FOR PVC OR TPO. IN CASE OF TPO, CAV-GRIP III ADHESIVE MAY ALSO BE USED ON VERTICAL PORTION.

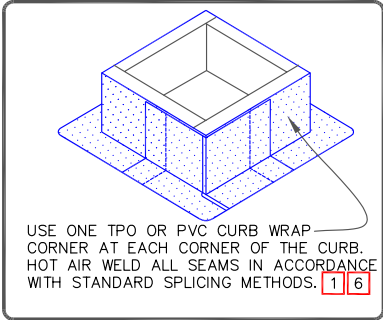

	CURB FLASHING WITH CFA TPO OR PVC CURB WRAP CORNERS		DETAIL NO.
	MAXIMUM WARRANTY: 30 YEARS		U-5C
		THERMOPLASTIC UNIVERSAL	

THERMOPLASTIC MEMBRANE PVC/TPO

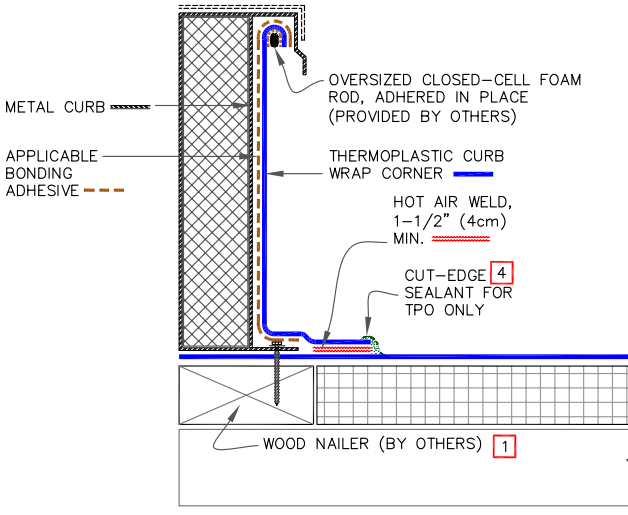

NOTES:

1. WOOD NAILER MUST EXTEND PAST TOTAL WIDTH OF CURB FLANGE.
2. FOUR (4) CURB WRAP CORNERS WILL COMPLETELY FLASH A MAXIMUM CURB SIZE OF 3'X3' (90cmX 90cm). FOR LARGER CURBS USE THE TPO OR PVC CURB WRAP CORNERS IN CONJUNCTION WITH ADDITIONAL SECTIONS OF SURE-WELD TPO OR SURE-FLEX PVC MEMBRANE.
3. IF CURB WRAP CORNER IS NOT USED, THEN USE **U-15G** DETAIL FOR OUTSIDE CORNERS.
4. APPROXIMATELY 1/8" (0.5cm) BEAD OF CUT-EDGE SEALANT IS REQUIRED ON THE CUT EDGES OF THE TPO FIELD WRAP CORNER.
5. REFER TO CARLISLE SPECIFICATIONS FOR ACCEPTABLE CARLISLE FASTENERS AND PLATES.
6. CUSTOM SIZES ARE AVAILABLE FOR CURB FLASHING HEIGHTS GREATER THAN 12" (30cm).
7. APPLICABLE BONDING ADHESIVE FOR PVC OR TPO. IN CASE OF TPO, CAV-GRIP III ADHESIVE MAY ALSO BE USED ON VERTICAL PORTION.

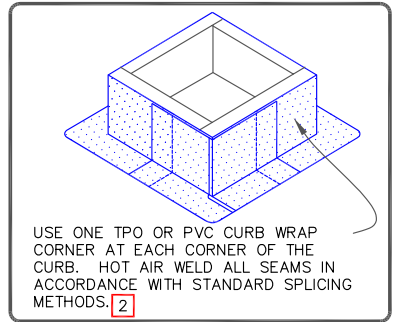

	SELF-FLASHING CURB WITH CFA TPO OR PVC CURB WRAP CORNERS		DETAIL NO.
	MAXIMUM WARRANTY: 30 YEARS		U-5D
		THERMOPLASTIC UNIVERSAL	

© 2023 Carlisle SynTec a division of Carlisle Construction Materials Incorporated

THERMOPLASTIC MEMBRANE

PVC/TPO

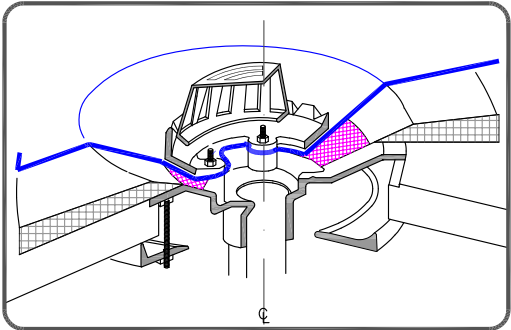
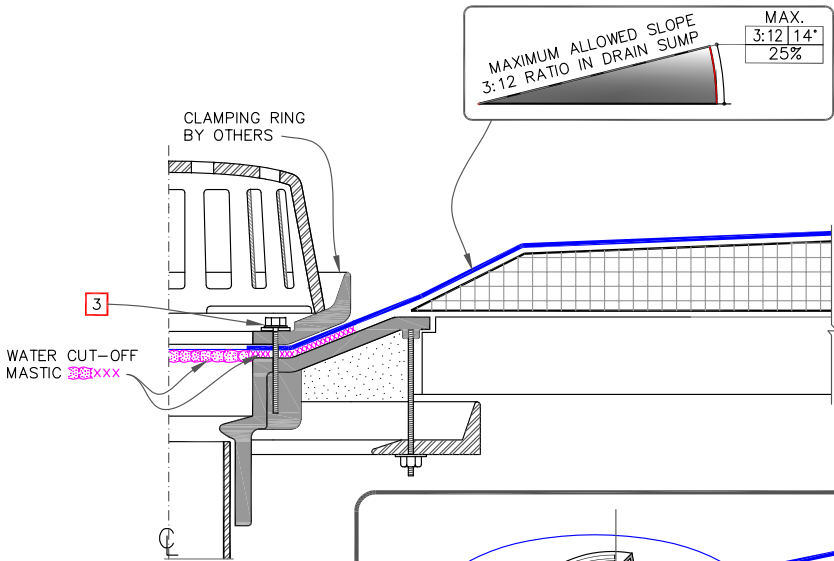

NOTES:

1. ROOF DRAIN SIZE AND NUMBER OF DRAINS SHALL BE IN ACCORDANCE WITH THE LOCAL CODES.
2. THE HOLE IN THE MEMBRANE SHALL EXCEED THE DIAMETER OF THE DRAIN PIPE, BUT SHALL BE NO LESS THAN 1/2" (1.5cm) FROM THE ATTACHMENT POINTS OF THE DRAIN CLAMPING RING.
3. ALL BOLTS OR CLAMPS MUST BE IN PLACE TO PROVIDE CONSTANT COMPRESSION ON WATER CUT-OFF MASTIC.
4. REMOVE EXISTING LEAD, FLASHING MATERIAL & ENSURE THE DRAIN RING IS COMPLETELY CLEAN DOWN TO BARE METAL.

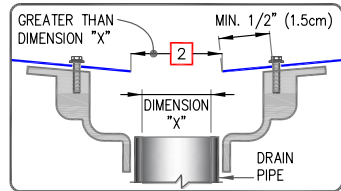

ROOF DRAIN (DRAIN SUMP UP TO 3 INCHES TO 1 HORIZONTAL FOOT)

MAXIMUM WARRANTY: 30 YEARS



DETAIL NO.
U-6A

THERMOPLASTIC UNIVERSAL

THERMOPLASTIC MEMBRANE

PVC/TPO

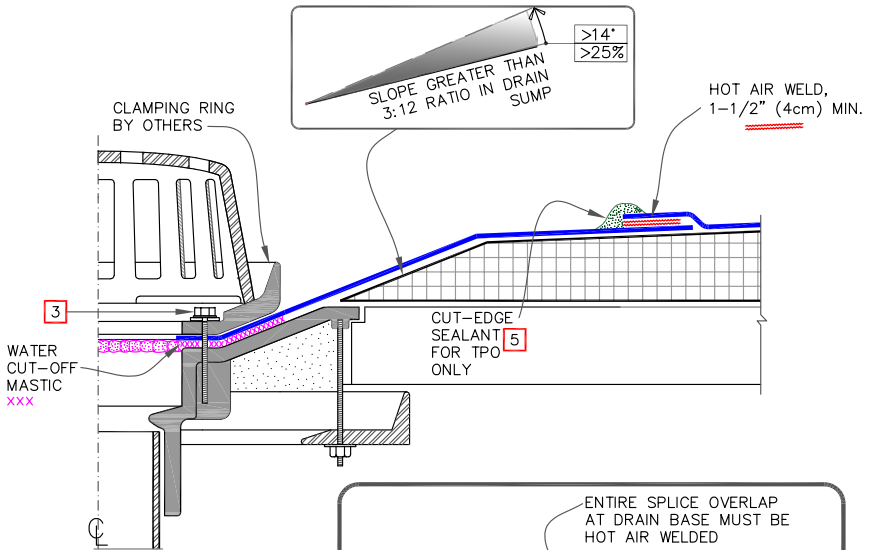

NOTES:

1. ROOF DRAIN SIZE AND NUMBER OF DRAINS SHALL BE IN ACCORDANCE WITH THE LOCAL CODES.
2. THE HOLE IN THE MEMBRANE SHALL EXCEED THE DIAMETER OF THE DRAIN PIPE, BUT SHALL BE NO LESS THAN 1/2" (1.5cm) FROM THE ATTACHMENT POINTS OF THE DRAIN CLAMPING RING.
3. ALL BOLTS OR CLAMPS MUST BE IN PLACE TO PROVIDE CONSTANT COMPRESSION ON WATER CUT-OFF MASTIC.
4. REMOVE EXISTING LEAD, FLASHING MATERIAL & ENSURE THE DRAIN RING IS COMPLETELY CLEAN DOWN TO BARE METAL.
5. APPROXIMATELY 1/8" (0.5cm) DIAMETER BEAD OF CUT-EDGE SEALANT IS REQUIRED ON CUT EDGES OF REINFORCED TPO MEMBRANE.

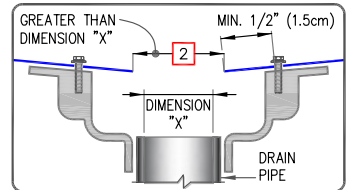
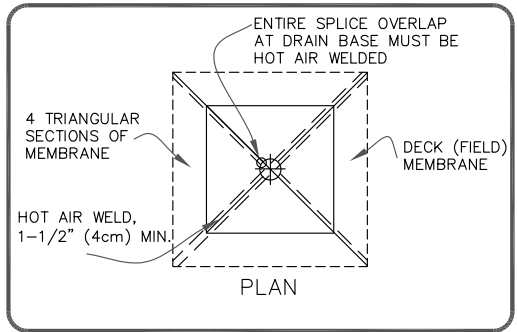

	ROOF DRAIN (DRAIN SUMP GREATER THAN 3 INCHES TO 1 HORIZONTAL FOOT) – OPTION 1		DETAIL NO.
	MAXIMUM WARRANTY: 30 YEARS		U-6B
		THERMOPLASTIC UNIVERSAL	

THERMOPLASTIC MEMBRANE

PVC/TPO

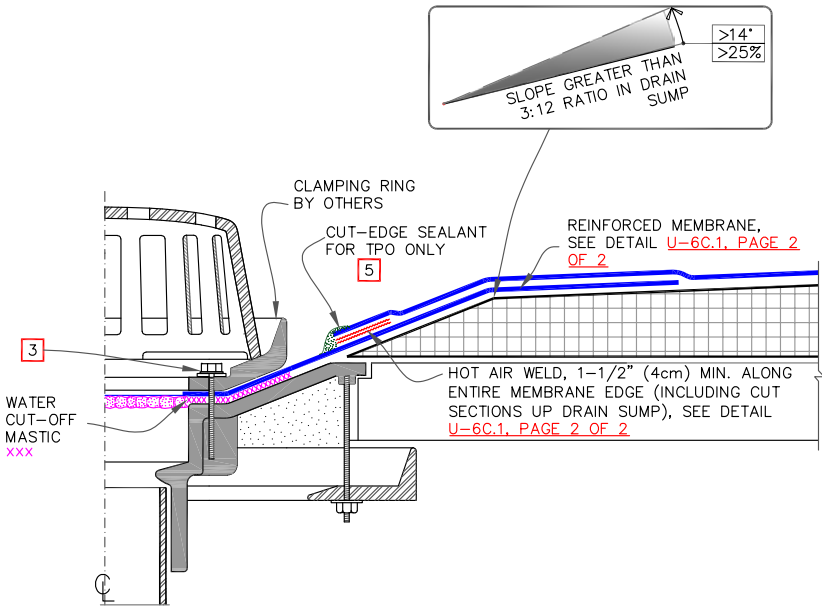

NOTES:

1. ROOF DRAIN SIZE AND NUMBER OF DRAINS SHALL BE IN ACCORDANCE WITH THE LOCAL CODES.
2. THE HOLE IN THE MEMBRANE SHALL EXCEED THE DIAMETER OF THE DRAIN PIPE, BUT SHALL BE NO LESS THAN 1/2" (1.5cm) FROM THE ATTACHMENT POINTS OF THE DRAIN CLAMPING RING.
3. ALL BOLTS OR CLAMPS MUST BE IN PLACE TO PROVIDE CONSTANT COMPRESSION ON WATER CUT-OFF MASTIC.
4. REMOVE EXISTING LEAD, FLASHING MATERIAL & ENSURE THE DRAIN RING IS COMPLETELY CLEAN DOWN TO BARE METAL.
5. APPROXIMATELY 1/8" (0.5cm) DIAMETER BEAD OF CUT-EDGE SEALANT IS REQUIRED ON CUT EDGES OF REINFORCED TPO MEMBRANE.

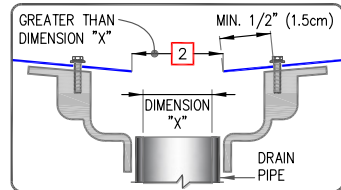

	ROOF DRAIN (DRAIN SUMP GREATER THAN 3 INCHES TO 1 HORIZONTAL FOOT) – OPTION 2, PAGE 1 OF 2		DETAIL NO.
	MAXIMUM WARRANTY: 30 YEARS		U-6C
		THERMOPLASTIC UNIVERSAL	

© 2023 Carlisle SynTec a division of Carlisle Construction Materials Incorporated

■■■■ THERMOPLASTIC MEMBRANE ■■■■ PVC/TPO ■■■■

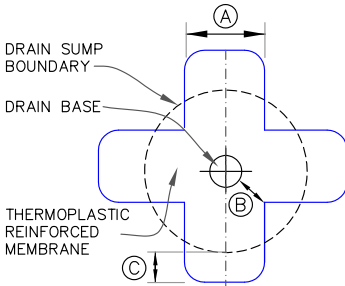

CUT SECTION OF THERMOPLASTIC REINFORCED MEMBRANE AS SHOWN AND POSITION INTO DRAIN SUMP. EXTEND MEMBRANE OUT OF DRAIN SUMP APPROXIMATELY 6" (15cm) (ROUND CORNERS).

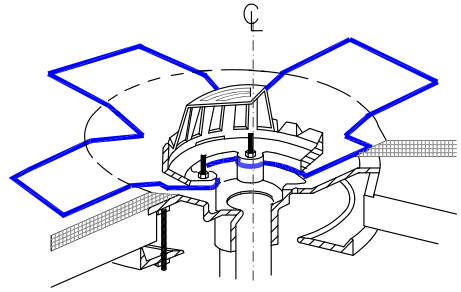

EXTEND THERMOPLASTIC MEMBRANE ONTO MEMBRANE SECTION POSITIONED AT DRAIN SUMP AND CUT AS SHOWN TO LAY FLAT IN SUMP. HOT AIR WELD A MINIMUM OF 1-1/2" (4cm) COMPLETELY SURROUNDING AREA.

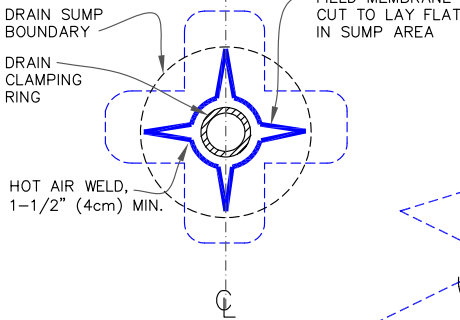

DIMENSIONS	cm	
(A)	12"	30 MIN.
(B)	6"	15 MIN.
(C)	6"	15 APPROX.
(D)	3"	7.5 MIN.

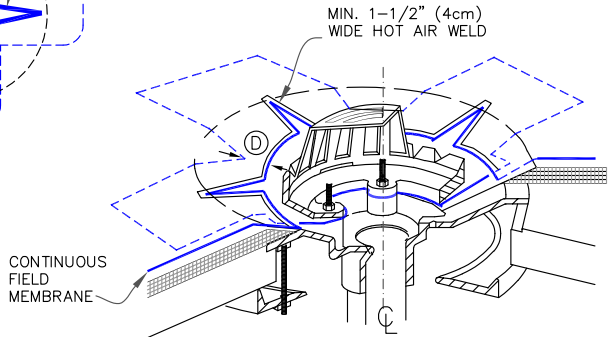

	ROOF DRAIN (DRAIN SUMP GREATER THAN 3 INCHES TO 1 HORIZONTAL FOOT) – OPTION 2, PAGE 2 OF 2	DETAIL NO. U-6C.1 THERMOPLASTIC UNIVERSAL
	MAXIMUM WARRANTY: 30 YEARS	

© 2023 Carlisle SynTec a division of Carlisle Construction Materials Incorporated

THERMOPLASTIC MEMBRANE PVC/TPO

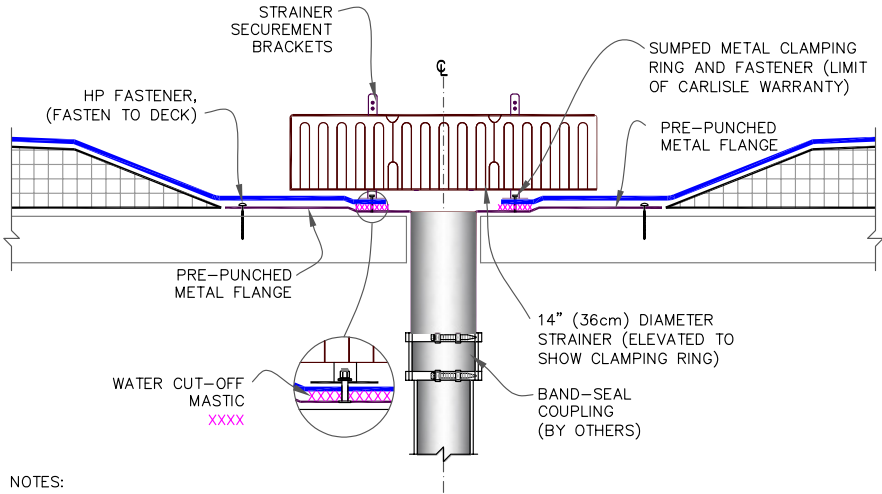

NOTES:

1. ROOF DRAIN SIZE AND NUMBER OF DRAINS SHALL BE IN ACCORDANCE WITH THE LOCAL CODES.
2. ALL BOLTS OR CLAMPS MUST BE IN PLACE TO PROVIDE CONSTANT COMPRESSION ON WATER CUT-OFF MASTIC.
3. THE HOLE IN THE MEMBRANE SHALL EXCEED THE DIAMETER OF THE DRAIN PIPE, BUT SHALL BE NO LESS THAN 1/2" (1.5cm) FROM THE ATTACHMENT POINTS OF THE DRAIN CLAMPING RING.
4. FIELD SPLICES MUST BE LOCATED AT LEAST 6" (15cm) OUTSIDE THE DRAIN SUMP.
5. INSULATION TAPER SHALL NOT BE GREATER THAN 6" (15cm) IN 12" (30cm) HORIZONTAL.

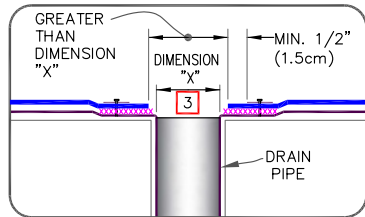

	ADD-ON DRAIN		DETAIL NO.
	MAXIMUM WARRANTY: 30 YEARS		U-6D
		THERMOPLASTIC UNIVERSAL	

© 2023 Carlisle SynTec a division of Carlisle Construction Materials Incorporated

THERMOPLASTIC MEMBRANE PVC/TPO

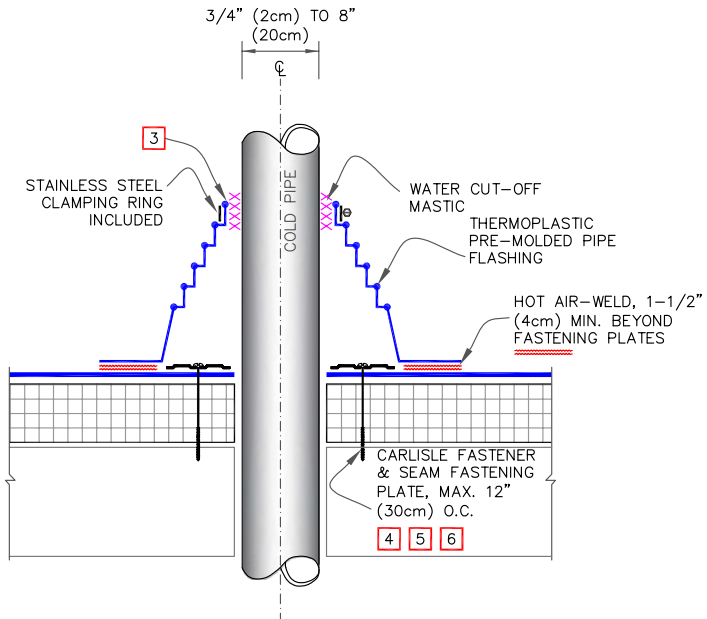

NOTES:

1. REMOVE ALL EXISTING LEAD AND FLASHING MATERIAL BEFORE INSTALLING PRE-MOLDED PIPE FLASHING.
2. TEMPERATURE OF THE PIPE PENETRATION MUST NOT EXCEED 140°F (60°C) WHEN USING PVC AND 160°F (71°C) WHEN USING TPO FLASHING.
3. PRE-MOLDED PIPE FLASHING MUST HAVE INTACT RIB AT THE TOP EDGE REGARDLESS OF PIPE DIAMETER.
4. INSTALL A MINIMUM OF 4 FASTENERS AND PLATES AROUND THE PIPE, EQUALLY SPACED. IF FASTENERS AND PLATES CANNOT BE INSTALLED AS SHOWN, THEY MAY ALSO BE POSITIONED OUTSIDE THE PIPE MAXIMUM 12" (30cm) O.C. AND FLASHED WITH THERMOPLASTIC REINFORCED MEMBRANE / TPO CUT-EDGE SEALANT. REFER TO [DETAIL U-8B](#).
5. FASTENERS AND PLATES ARE NOT REQUIRED ON ADHERED SYSTEMS UNLESS PIPE DIAMETER EXCEEDS 18" (46cm).
6. ON MECHANICALLY FASTENED SYSTEMS, HP-X FASTENERS AND PIRANHA PLATES OR HP-XTRA FASTENERS AND PIRANHA XTRA PLATES ARE REQUIRED OVER STEEL AND WOOD DECKS. ON CONCRETE DECKS, CD-10 OR HD 14-10 FASTENERS ARE USED WITH PIRANHA PLATES.

	PRE-MOLDED PIPE FLASHING		DETAIL NO.
	MAXIMUM WARRANTY: 30 YEARS		U-8A
		THERMOPLASTIC UNIVERSAL	

© 2023 Carlisle SynTec a division of Carlisle Construction Materials Incorporated

THERMOPLASTIC MEMBRANE

PVC/TPO

CAUTION

DETAIL NOT FOR USE ON 25 OR 30-YEAR WARRANTY PROJECTS, PRE-FABRICATED/PRE-MOLDED ACCESSORIES MUST BE UTILIZED. ACCEPTABLE PIPE FLASHINGS SHALL CONFORM WITH THERMOPLASTIC UNIVERSAL DETAILS **U-8A** OR **U-8C**.

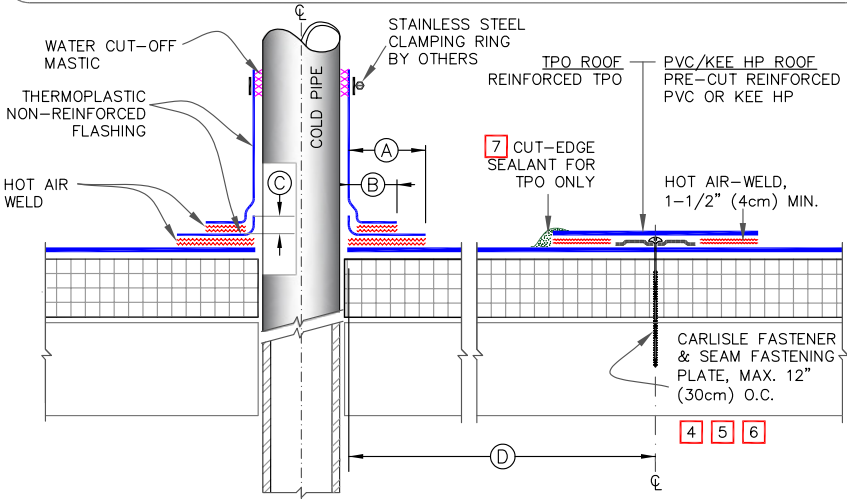

NOTES:

- REMOVE ALL EXISTING LEAD AND FLASHING MATERIAL BEFORE INSTALLING FIELD FABRICATED PIPE FLASHING.
- TEMPERATURE OF THE PIPE PENETRATION MUST NOT EXCEED 140°F (60°C) WHEN USING PVC AND 160°F (71°C) WHEN USING TPO FLASHING.
- THERMOPLASTIC NON-REINFORCED FLASHING WRAPPED AROUND PIPE SHALL HAVE MINIMUM 1-1/2" (4cm) VERTICAL HOT AIR WELD.
- INSTALL A MINIMUM OF 4 SEAM FASTENING PLATES FOR PIPES WITH A DIAMETER UP TO 6" (15cm). ADDITIONAL SEAM FASTENING PLATES WILL BE REQUIRED FOR PIPES GREATER THAN 6" (15cm) IN DIAMETER AND SHALL BE SPACED 12" (30cm) ON CENTER MAXIMUM.
- FASTENERS/PLATES ARE NOT REQUIRED ON ADHERED SYSTEMS UNLESS PIPE DIAMETER EXCEEDS 18" (50cm).
- ON MECHANICALLY FASTENED SYSTEMS, HP-X FASTENERS AND PIRANHA PLATES OR HP-XTRA FASTENERS AND PIRANHA XTRA PLATES ARE REQUIRED OVER STEEL AND WOOD DECKS. ON CONCRETE DECKS, CD-10 OR HD 14-10 FASTENERS ARE USED WITH PIRANHA PLATES.
- APPROXIMATELY 1/8" (0.5cm) DIAMETER BEAD OF CUT-EDGE SEALANT IS REQUIRED ON CUT EDGES OF REINFORCED TPO MEMBRANE ONLY.

DIMENSIONS		cm	
(A)	1-1/2"	4	TO
	2"	5	
(B)	1"	2.5	MIN.
(C)	1/2"	1.5	MIN.
(D)	12"	30	APPROX.

	FIELD FABRICATED PIPE FLASHING		DETAIL NO.
	MAXIMUM WARRANTY: 20 YEARS		U-8B
		THERMOPLASTIC UNIVERSAL	

© 2023 Carlisle SynTec a division of Carlisle Construction Materials Incorporated

■■■■ THERMOPLASTIC MEMBRANE ■■■■ PVC/TPO ■■■■

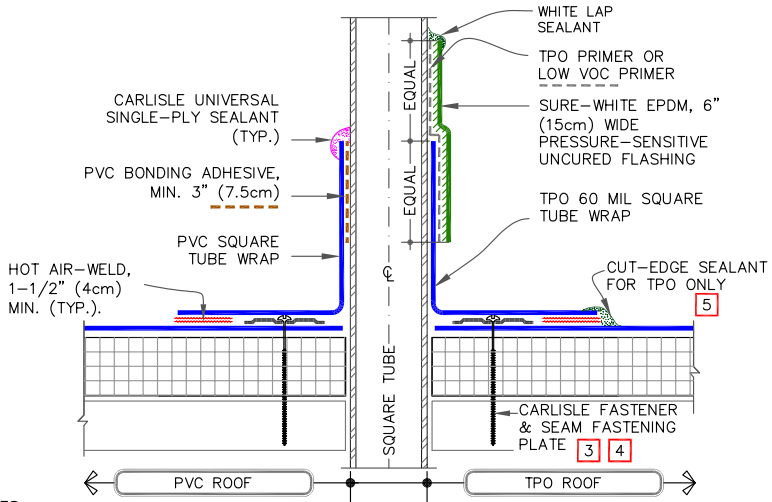

NOTES:

1. REMOVE ALL EXISTING LEAD AND FLASHING MATERIAL BEFORE INSTALLING PRE-FABRICATED SQUARE TUBE WRAP.
2. TEMPERATURE OF THE PIPE PENETRATION MUST NOT EXCEED 140°F (60°C) WHEN USING PVC AND 160°F (71°C) WHEN USING TPO FLASHING.
3. INSTALL A MINIMUM OF 4 SEAM FASTENING PLATES FOR TUBE SIDE DIMENSIONS UP TO 6" (15cm).
4. FASTENERS AND PLATES ARE NOT REQUIRED ON ADHERED SYSTEM. SEE TABLE FOR MF SYSTEM.
5. APPROXIMATELY 1/8" (0.5cm) DIAMETER BEAD OF CUT-EDGE SEALANT IS REQUIRED ON CUT EDGES OF REINFORCED TPO MEMBRANE.
6. T-JOINT COVERS ARE NOT REQUIRED ON WHITE, TAN OR GRAY, FOR ADDITIONAL COLORS IT IS REQUIRED TO COVER T-JOINTS.

FASTENER TYPES ON MECHANICALLY FASTENED ROOF ASSEMBLY		
DECK TYPE	FASTENERS	PLATES
STEEL & WOOD DECK	HP-X	PIRANHA
	OR	
	HP-XTRA	PIRANHA XTRA
CONCRETE DECK	CD-10 OR HD 14-10	PIRANHA

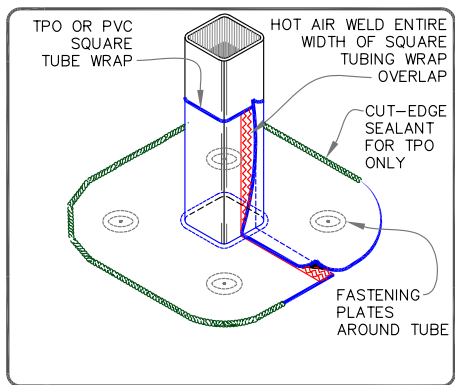

	CFA CERTIFIED PRE-FABRICATED SQUARE TUBE WRAP		DETAIL NO.
	MAXIMUM WARRANTY: 30 YEARS		U-8C

THERMOPLASTIC MEMBRANE PVC/TPO

DIMENSIONS	cm	
(A)	6"	15 MAX.
(B)	1-1/2"	4 MIN.
(C)	1/2"	1.5 MIN.
(D)	1"	2.5 MIN.
(E)	12"	30 APPROX.

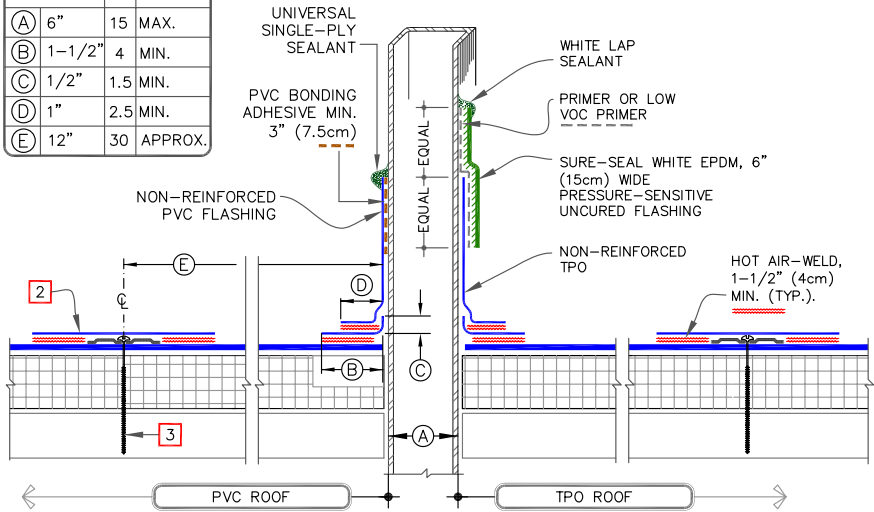

FASTENER TYPES ON MECHANICALLY FASTENED ROOF ASSEMBLY		
DECK TYPE	FASTENERS	PLATES
STEEL & WOOD DECK	HP-X	PIRANHA
	OR	
	HP-XTRA	PIRANHA XTRA
CONCRETE DECK	CD-10 OR	PIRANHA
	HD 14-10	

NOTES:

1. REMOVE ALL EXISTING LEAD AND FLASHING MATERIAL BEFORE INSTALLING PRE-FABRICATED SQUARE TUBE WRAP.
2. 8" (20cm) PRE-CUT PVC REINFORCED COVER STRIP. KEE HP 8" REINFORCED COVER STRIP IS AVAILABLE FOR USE WITH KEE HP MEMBRANE.
3. CARLISLE FASTENERS & SEAM FASTENING PLATES FOR MECHANICALLY FASTENED SYSTEM (NOT REQUIRED ON ADHERED SYSTEM). SEE TABLE ABOVE.
4. T-JOINT COVERS ARE NOT REQUIRED ON WHITE, TAN OR GRAY. FOR ADDITIONAL COLORS IT IS REQUIRED TO COVER T-JOINTS.

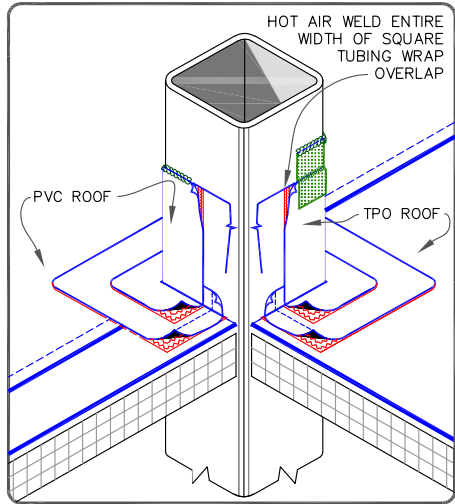

	FIELD-FABRICATED SQUARE TUBE FLASHING		DETAIL NO.
	MAXIMUM WARRANTY: 20 YEARS		U-8D
		THERMOPLASTIC UNIVERSAL	

THERMOSET MEMBRANE

EPDM

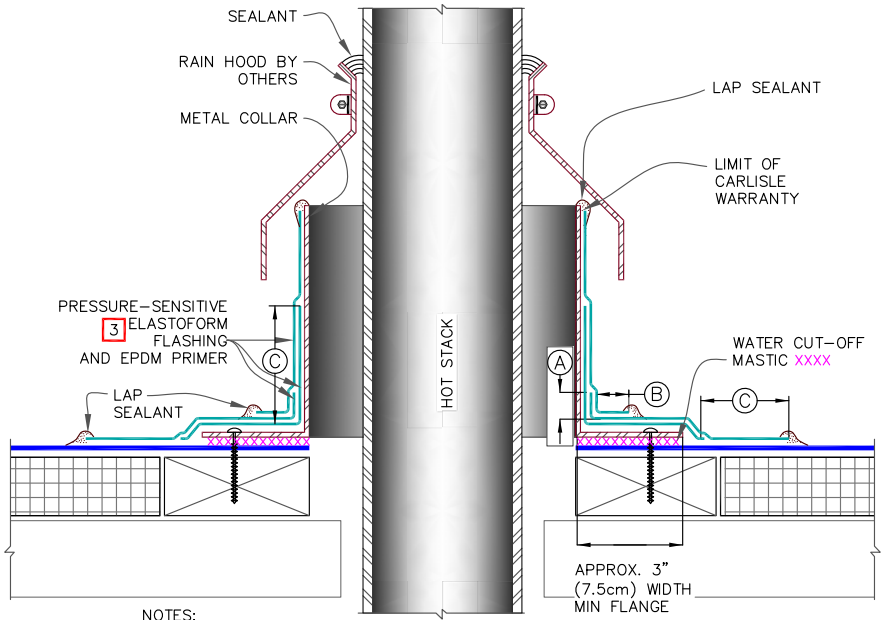

NOTES:

1. REMOVE ALL LEAD AND OTHER FLASHING BEFORE INSTALLING FIELD FABRICATED PIPE SEAL.
2. TEMPERATURE OF METAL COLLAR MUST NOT EXCEED 180°F (82°C).
3. IN COLDER TEMPERATURES, A HEAT GUN MUST BE USED WHEN FORMING PRESSURE-SENSITIVE ELASTOFORM FLASHING.

DIMENSIONS	cm	
(A)	1/2"	1.5 MIN.
(B)	1"	2.5 MIN.
(C)	3"	7.5 MIN.

	FIELD FABRICATED HOT STACK (25/30 YEAR WARRANTIES)		DETAIL NO.
	MAXIMUM WARRANTY: 30 YEARS		U-8D.1
		THERMOSET UNIVERSAL	

© 2023 Carlisle SynTec a division of Carlisle Construction Materials Incorporated

THERMOPLASTIC MEMBRANE

PVC/TPO

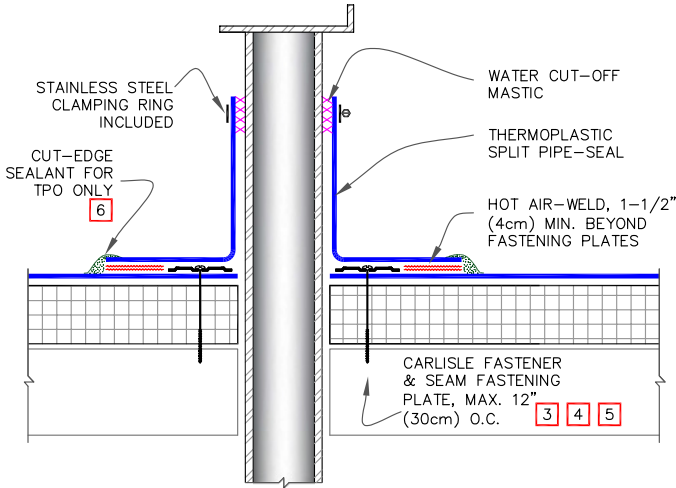

NOTES:

1. REMOVE ALL EXISTING LEAD AND FLASHING MATERIAL BEFORE INSTALLING SPLIT PIPE FLASHING.
2. TEMPERATURE OF THE PIPE PENETRATION MUST NOT EXCEED 140°F (60°C) WHEN USING PVC AND 160°F (71°C) WHEN USING TPO.
3. INSTALL A MINIMUM OF 4 FASTENERS AND PLATES AROUND THE PIPE, EQUALLY SPACED. IF FASTENERS AND PLATES CANNOT BE INSTALLED AS SHOWN, THEY MAY ALSO BE POSITIONED OUTSIDE THE PIPE MAXIMUM 12" (30cm) O.C. AND FLASHED WITH THERMOPLASTIC REINFORCED MEMBRANE/CUT-EDGE SEALANT. REFER TO [DETAIL U-8B](#).
4. FASTENERS AND PLATES ARE NOT REQUIRED ON ADHERED SYSTEMS UNLESS PIPE DIAMETER EXCEEDS 18" (46cm).
5. ON MECHANICALLY FASTENED SYSTEMS, HP-X FASTENERS AND PIRANHA PLATES OR HP-XTRA FASTENERS AND PIRANHA XTRA PLATES ARE REQUIRED OVER STEEL AND WOOD DECKS. ON CONCRETE DECKS, CD-10 OR HD 14-10 FASTENERS ARE USED WITH PIRANHA PLATES.
6. APPROXIMATELY 1/8" (0.5cm) DIAMETER BEAD OF CUT-EDGE SEALANT IS REQUIRED ON CUT EDGES OF REINFORCED TPO MEMBRANE ONLY.
7. T-JOINT COVERS ARE NOT REQUIRED ON WHITE, TAN OR GRAY, FOR ADDITIONAL COLORS IT IS REQUIRED TO COVER T-JOINTS.

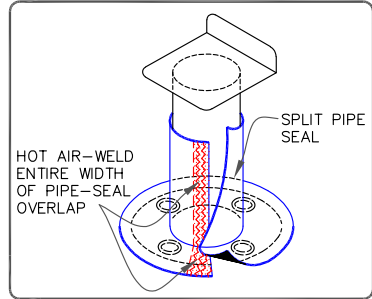

	CFA CERTIFIED PRE-FABRICATED SPLIT PIPE SEAL		DETAIL NO. U-8E
	MAXIMUM WARRANTY: 30 YEARS		THERMOPLASTIC UNIVERSAL

© 2023 Carlisle SynTec a division of Carlisle Construction Materials Incorporated

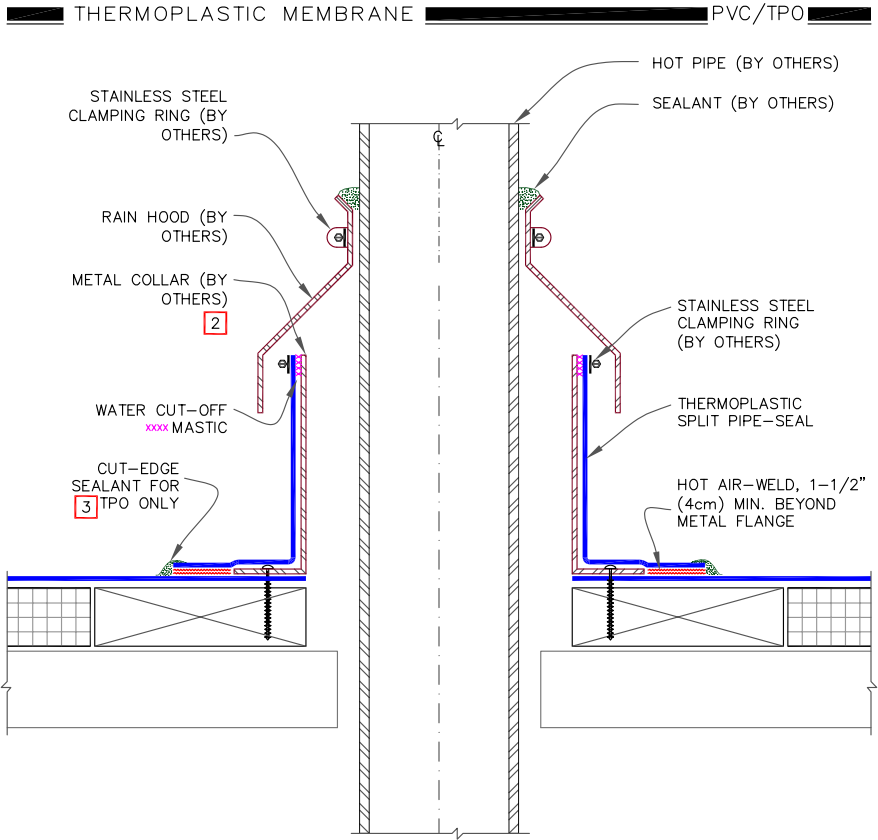

NOTES:

1. REMOVE ALL EXISTING LEAD AND FLASHING MATERIAL BEFORE INSTALLING PIPE FLASHING.
2. TEMPERATURE OF THE METAL COLLAR MUST NOT EXCEED 140°F (60°C) WHEN USING PVC AND 160°F (71°C) WHEN USING TPO.
3. APPROXIMATELY 1/8" (0.5cm) DIAMETER BEAD OF CUT-EDGE SEALANT IS REQUIRED ON CUT EDGES OF REINFORCED TPO MEMBRANE ONLY.
4. T-JOINT COVERS ARE NOT REQUIRED ON WHITE, TAN OR GRAY, FOR ADDITIONAL COLORS IT IS REQUIRED TO COVER T-JOINTS.

	CFA CERTIFIED HOT PIPE FLASHING		DETAIL NO.
	MAXIMUM WARRANTY: 30 YEARS		U-8F
		THERMOPLASTIC UNIVERSAL	

© 2023 Carlisle SynTec a division of Carlisle Construction Materials Incorporated

THERMOPLASTIC MEMBRANE

PVC/TPO

9A MECHANICAL TERMINATION WITH COUNTER FLASHING

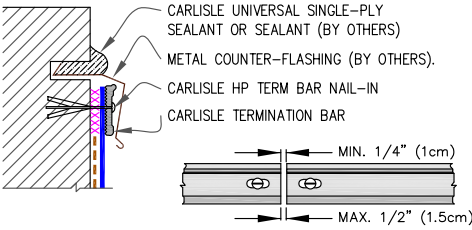

NOTES:

1. APPLY ON HARD SMOOTH SURFACE ONLY; NOT FOR USE ON EXPOSED WOOD.
2. DO NOT WRAP TERMINATION BAR AROUND CORNERS.
3. DETAIL REQUIRED FOR USE ON WARRANTY PROJECTS EXCEEDING 20-YEARS.
4. DETAIL **9E** MUST BE USED AT VERTICAL JOINTS IN PANEL WALLS.

9B SHEET METAL COPING (BY OTHERS)

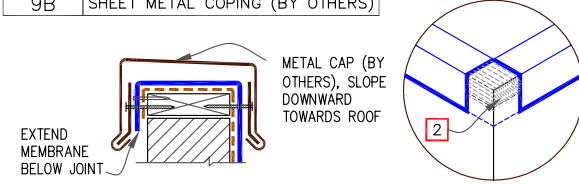

NOTES:

1. FOR CARLISLE SecurEdge COPING, REFER TO INSTALLATION INSTRUCTIONS PUBLISHED SEPARATELY.
2. MEMBRANE MUST BE EXTENDED TO CORNERS TO PROVIDE COMPLETE COVERAGE OF THE TOP WALL SURFACE.

9C COUNTER FLASHING TERMINATION

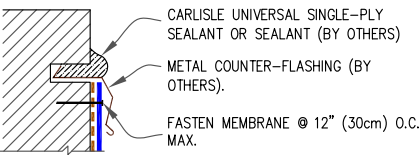

NOTES:

1. WHEN MECHANICAL FASTENERS ARE USED TO PENETRATE THE METAL COUNTER-FLASHING, USE EPDM WASHERS, APPLY WATER CUT-OFF MASTIC UNDER THE COUNTER-FLASHING OR CAULK THE FASTENER HEADS.
2. DETAIL NOT FOR USE ON WARRANTY PROJECTS EXCEEDING 10-YEARS.

9D MECHANICAL TERMINATION

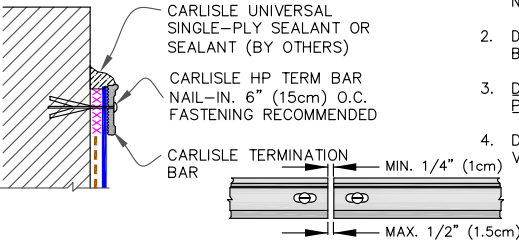

NOTES:

1. APPLY ON HARD SMOOTH SURFACE ONLY; NOT FOR USE ON EXPOSED WOOD.
2. DO NOT WRAP COMPRESSION TERMINATION BAR AROUND CORNERS.
3. DETAIL NOT FOR USE ON WARRANTY PROJECTS EXCEEDING 20-YEARS.
4. DETAIL **9E** MUST BE USED AT VERTICAL JOINTS IN PANEL WALLS.

--- APPLICABLE BONDING ADHESIVE.

xxx WATER CUT-OFF MASTIC- MUST BE HELD UNDER CONSTANT COMPRESSION.

	MEMBRANE TERMINATIONS PAGE 1 OF 2		DETAIL NO. U-9
	MAXIMUM WARRANTY: 30 YEARS		THERMOPLASTIC UNIVERSAL

THERMOPLASTIC MEMBRANE **PVC/TPO**

9E MECHANICAL TERMINATION AT VERTICAL JOINT

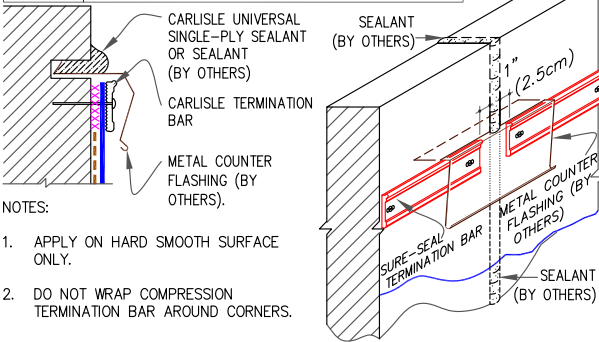

3. VERTICAL JOINTS IN THE PRE-CAST PANEL AS WELL AS ALL GAPS AT THE JUNCTION OF THE TILT-UP PANEL AND ROOF DECK MUST BE FULLY SEALED TO PREVENT AIR INFILTRATION.
4. CONTINUOUS COUNTER FLASHING REQUIRED FOR WARRANTY PROJECTS EXCEEDING 20-YEARS.
5. THIS DETAIL MUST BE USED FOR ANY PROJECT REGARDLESS OF WARRANTY

NOTES:

1. APPLY ON HARD SMOOTH SURFACE ONLY.
2. DO NOT WRAP COMPRESSION TERMINATION BAR AROUND CORNERS.

9F SecurEdge 200 & 300 COPING

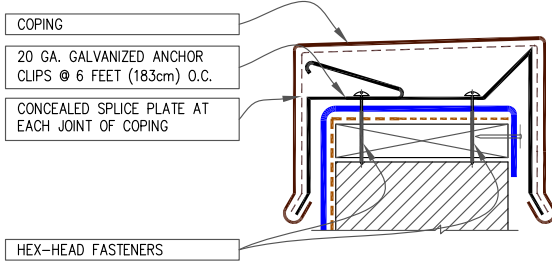

NOTES:

1. MEMBRANE MUST BE EXTENDED AT CORNERS TO PROVIDE COMPLETE COVERAGE OF THE TOP WALL SURFACE. REFER TO [DETAIL U-9B](#).
2. REFER TO [SecurEdge COPING INSTALLATION INSTRUCTION](#) MANUAL FOR STEP-BY-STEP INSTRUCTION PROCEDURES.

9G COPING STONE TERMINATION

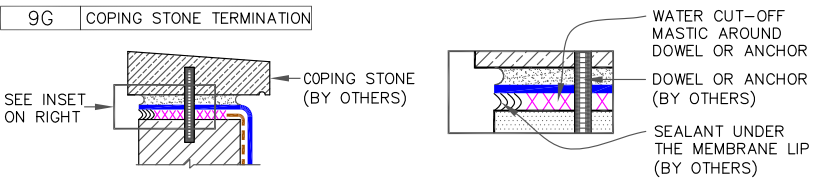

--- APPLICABLE BONDING ADHESIVE.

xxx WATER CUT-OFF MASTIC- MUST BE HELD UNDER CONSTANT COMPRESSION.

	MEMBRANE TERMINATIONS PAGE 2 OF 2		DETAIL NO. U-9
	MAXIMUM WARRANTY: 30 YEARS		THERMOPLASTIC UNIVERSAL

THERMOPLASTIC MEMBRANE

PVC/TPO

CAUTION

FASTENERS AND PLATES ARE REQUIRED AT 6" (15cm) O.C. FOR ADHERED SYSTEMS WITH WARRANTY WIND SPEED COVERAGE GREATER THAN 90 MPH AND FOR ALL PROJECTS WITH WARRANTIES GREATER THAN 20 YEARS.

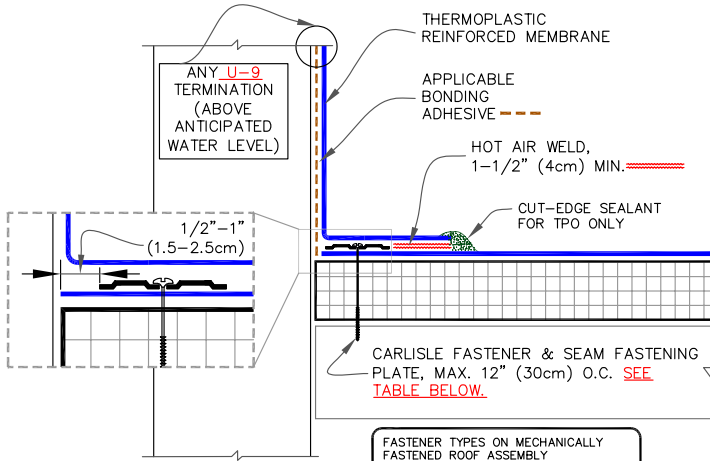

DECK TYPE	FASTENERS	PLATES
STEEL & WOOD DECK	HP-X	PIRANHA
	OR	
	HP-XTRA	PIRANHA XTRA
CONCRETE DECK	CD-10 OR HD 14-10	PIRANHA

NOTES:

1. IN CASES WHERE FASTENERS MUST BE FASTENED INTO THE VERTICAL SURFACE, CARE MUST BE TAKEN TO PRESS THE MEMBRANE TIGHTLY INTO THE ANGLE CHANGE. PLACING THE PLATES TIGHT INTO THE ANGLE CHANGE WILL HELP HOLD THE MEMBRANE IN THE PROPER POSITION.
2. FOLLOW U-9 DETAILS FOR WARRANTY DURATION.

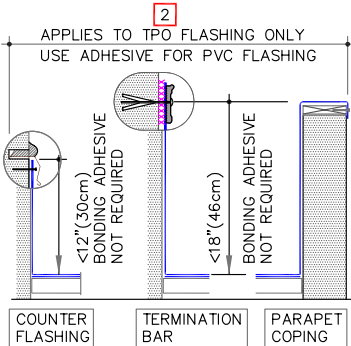

	PARAPET FLASHING – FASTENED INTO DECK		DETAIL NO.
	MAXIMUM WARRANTY: 30 YEARS		U-12A
		THERMOPLASTIC UNIVERSAL	

THERMOPLASTIC MEMBRANE PVC/TPO

CAUTION

FASTENERS AND PLATES ARE REQUIRED AT 6" (15cm) O.C. FOR ADHERED SYSTEMS WITH WARRANTY WIND SPEED COVERAGE GREATER THAN 90 MPH AND FOR ALL PROJECTS WITH WARRANTIES GREATER THAN 20 YEARS.

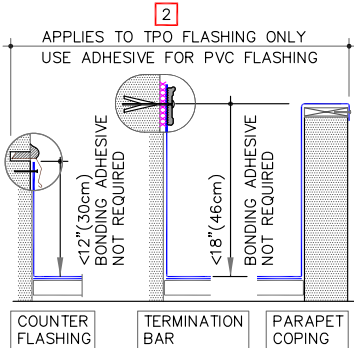
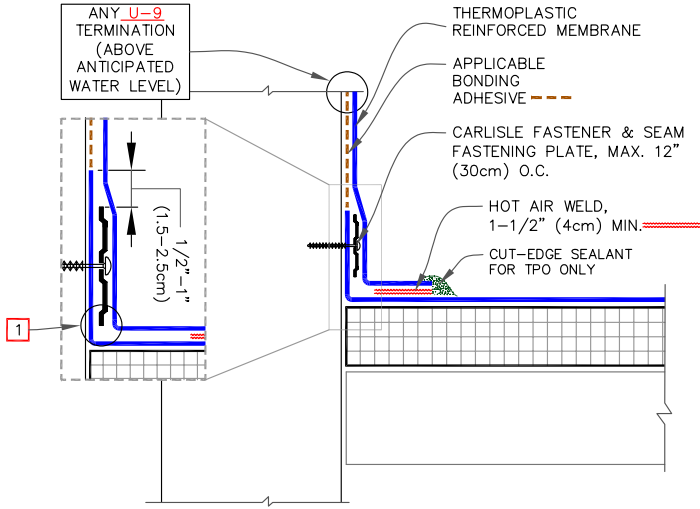

NOTES:

- CARE MUST BE TAKEN TO PRESS THE MEMBRANE TIGHTLY INTO THE ANGLE CHANGE. PLACING THE PLATES TIGHT INTO THE ANGLE CHANGE WILL HELP HOLD THE MEMBRANE IN THE PROPER POSITION.
- FOLLOW U-9 DETAILS FOR WARRANTY DURATION.

	PARAPET FLASHING – FASTENED INTO WALL		DETAIL NO.
	MAXIMUM WARRANTY: 30 YEARS		U-12A.1
		THERMOPLASTIC UNIVERSAL	

© 2023 Carlisle SynTec a division of Carlisle Construction Materials Incorporated

THERMOPLASTIC MEMBRANE

TPO

CAUTION

FASTENERS AND PLATES ARE REQUIRED AT 6" (15cm) O.C. FOR ADHERED SYSTEMS WITH WARRANTY WIND SPEED COVERAGE GREATER THAN 90 MPH AND FOR ALL PROJECTS WITH WARRANTIES GREATER THAN 20 YEARS.

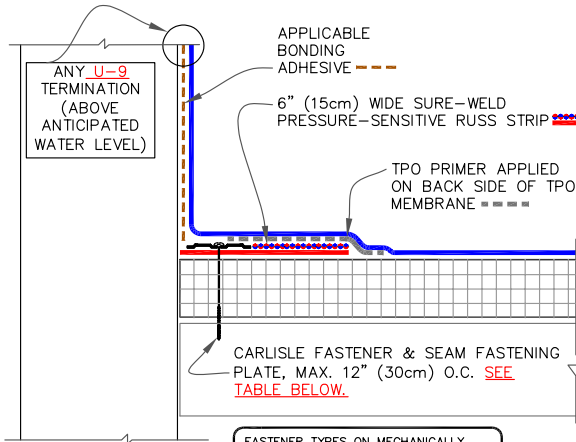

TPO ONLY
(NOT FOR PVC)

FASTENER TYPES ON MECHANICALLY FASTENED ROOF ASSEMBLY		
DECK TYPE	FASTENERS	PLATES
STEEL & WOOD DECK	HP-X	PIRANHA
	OR	
	HP-XTRA	PIRANHA XTRA
CONCRETE DECK	CD-10 OR	PIRANHA
	HD 14-10	

2

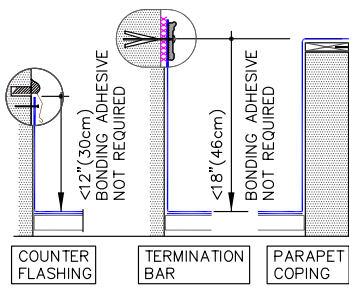

NOTES:

1. IN A CASE WHERE FASTENERS MUST BE FASTENED INTO THE VERTICAL SURFACE, CARE MUST BE TAKEN TO PRESS THE RUSS, AS WELL AS THE MEMBRANE, TIGHTLY INTO THE ANGLE CHANGE TO MAXIMIZE CONTACT BETWEEN THE TAPE AND MEMBRANE. MEMBRANE MUST BE ADHERED TO THE FULL WIDTH OF THE TAPE. PLACING THE PLATES TIGHT INTO THE ANGLE CHANGE WILL HELP HOLD THE RUSS IN THE PROPER POSITION.
2. FOLLOW U-9 DETAILS FOR WARRANTY DURATION.

	PARAPET FLASHING WITH PRESSURE-SENSITIVE RUSS, PAGE 1 OF 2		DETAIL NO.
	MAXIMUM WARRANTY: 30 YEARS		U-12B
		THERMOPLASTIC TPO	

© 2023 Carlisle SynTec a division of Carlisle Construction Materials Incorporated

THERMOPLASTIC MEMBRANE

TPO

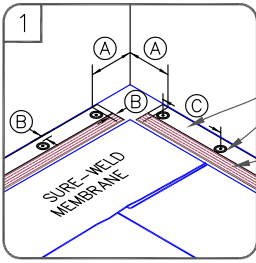

- 6" (15cm) WIDE PRESSURE-SENSITIVE RUSS
- CARLISLE FASTENER & SEAM FASTENING PLATE, MAX. 12" (30cm) O.C.
- PRE-APPLIED PRESSURE-SENSITIVE TAPE
- TPO PRIMER
- SURE-WELD BONDING ADHESIVE

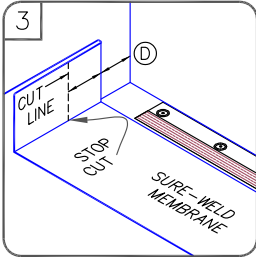
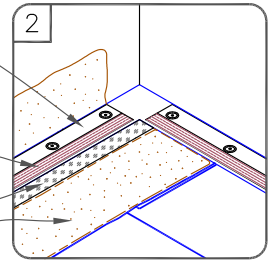

DIMENSIONS	cm	
(A) 6"	15	TO
9"	23	
(B) 1/8"	0.5	MIN.
1"	2.5	MAX.
(C) 12"	30	MIN.
(D) 6"	15	MIN.
(E) 1-1/2"	4	MIN.

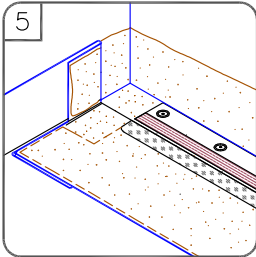
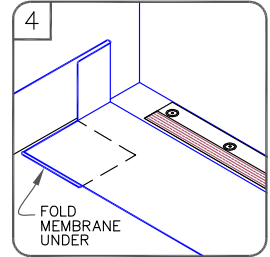

- HOT AIR WELD FLAP IN [STEP 7](#)
- CUT AT 45°

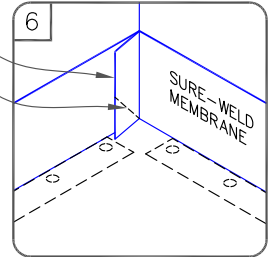

NOTES:

1. THE CUT SECTION OF VERTICAL MEMBRANE WILL BE FOLDED UNDER THE FIELD MEMBRANE AS SHOWN IN [STEP 4](#).
2. APPLY INSIDE CORNER IN ACCORDANCE WITH CARLISLE [DETAILS SW-15A OR SW-15B](#).

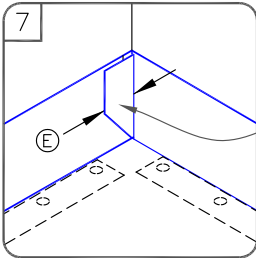

HOT AIR WELD

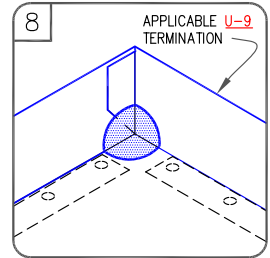

	PARAPET FLASHING WITH PRESSURE-SENSITIVE RUSS- PAGE 2 OF 2		DETAIL NO.
	MAXIMUM WARRANTY: 30 YEARS		U-12B.1
		THERMOPLASTIC TPO	

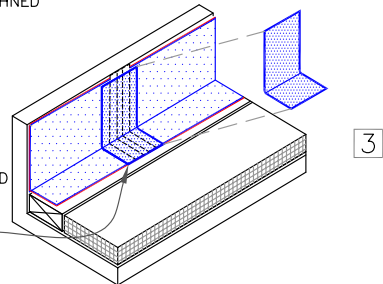
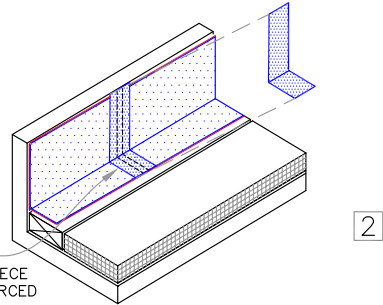
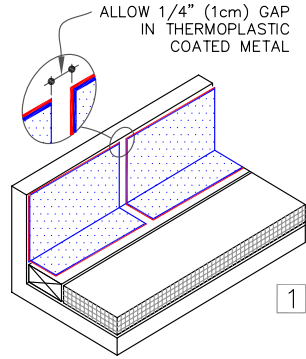
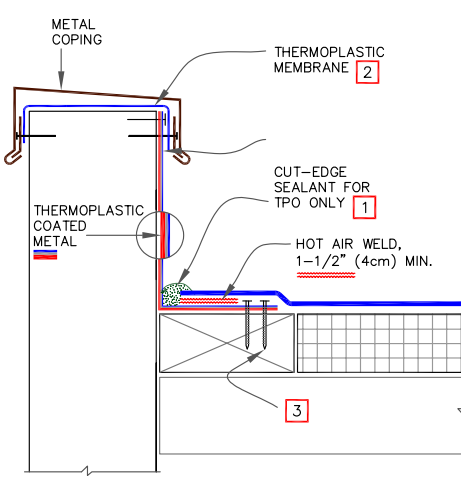

NOTES:

1. APPROXIMATELY 1/8" (0.5cm) DIAMETER BEAD OF CUT-EDGE SEALANT IS REQUIRED ON CUT EDGES OF REINFORCED TPO MEMBRANE.
2. PLACE A LAYER OF THERMOPLASTIC MEMBRANE UNDER THE METAL CAP TO PROTECT AGAINST MOISTURE INFILTRATION AT JOINTS.
3. FASTEN COATED METAL FLASHING TO WOOD NAILERS USING 1-1/2" (4cm) MIN. RING SHANK NAILS SPACED 6" (15cm) ON CENTER AND STAGGERED APPROX. 1/2" (1.5cm).

HEAT WELD 3" (7.5cm) WIDE PIECE OF NON-REINFORCED MEMBRANE CENTRALLY ALIGNED OVER JOINT

HEAT WELD 6" (15cm) WIDE PIECE OF NON-REINFORCED MEMBRANE CENTRALLY ALIGNED OVER JOINT.



COATED METAL WALL FLASHING		DETAIL NO.
MAXIMUM WARRANTY: 30 YEARS		U-12C
		THERMOPLASTIC UNIVERSAL

THERMOPLASTIC MEMBRANE

PVC/TPO

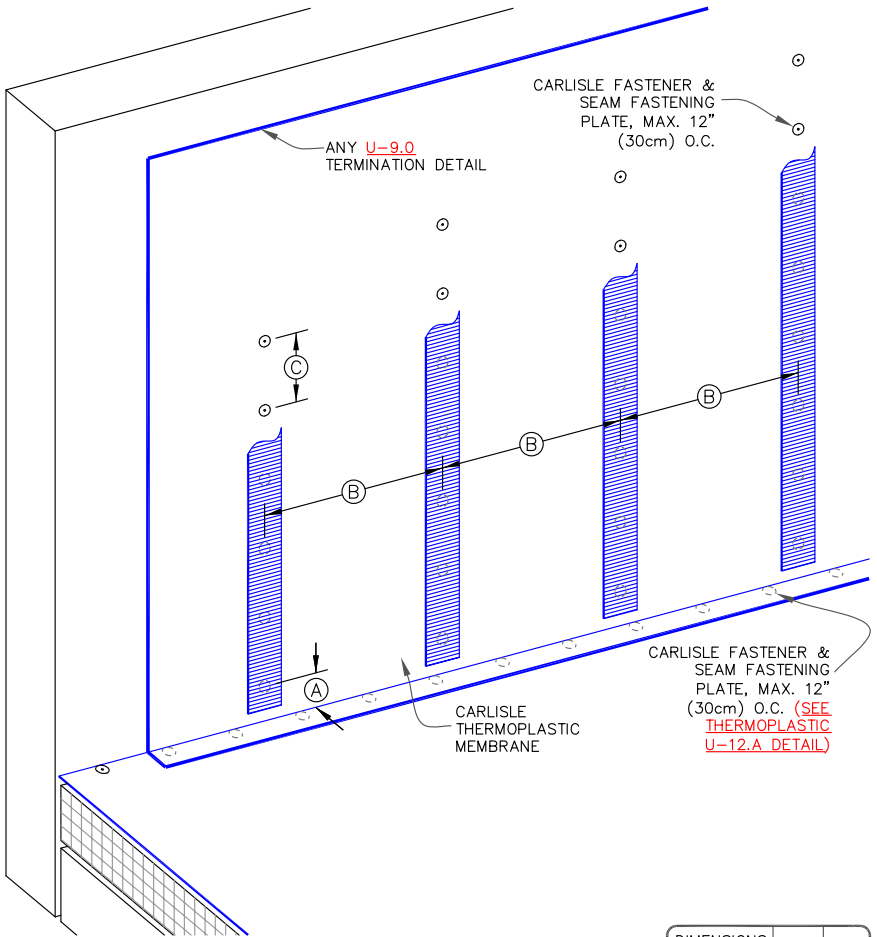

NOTE:

1. FOR TPO, USE 6" (15cm) WIDE PS COVERSTRIP, FOR PVC USE 6" (15cm) WIDE REINFORCED PVC MEMBRANE, HOT AIR WELD ALL EDGES WITH MIN. 1-1/2" (4cm) PAST FASTENING PLATES

DIMENSIONS	cm	
(A) 6"	15	
(B) 32"	80	MAX.
(C) 12"	30	MAX.

	PARAPET FLASHING / NO ADHESION - ANY HEIGHT OPTION		DETAIL NO.
	MAXIMUM WARRANTY: 30 YEARS		U-12F
		THERMOPLASTIC UNIVERSAL	

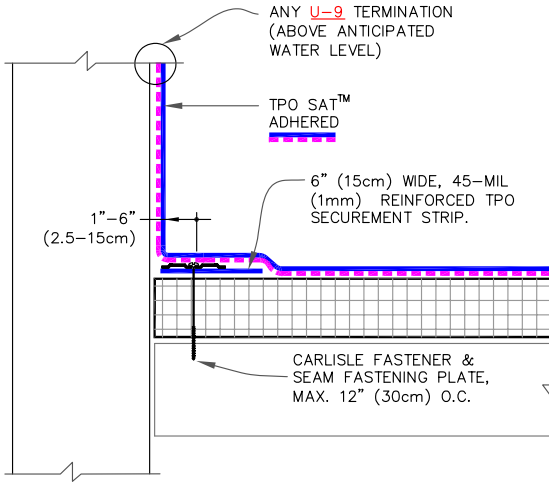

© 2023 Carlisle SynTec a division of Carlisle Construction Materials Incorporated

THERMOPLASTIC MEMBRANE TPO

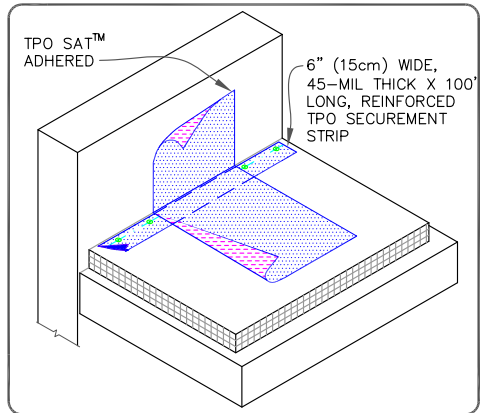

TPO SAT ONLY
(NOT FOR PVC)



	TPO SAT PARAPET FLASHING WITH TPO SECUREMENT STRIP		DETAIL NO.
	SAT™ (SELF ADHERING TECHNOLOGY)		U-12G
	MAXIMUM WARRANTY: 30 YEARS		THERMOPLASTIC TPO

© 2023 Carlisle SynTec a division of Carlisle Construction Materials Incorporated

THERMOPLASTIC MEMBRANE TPO

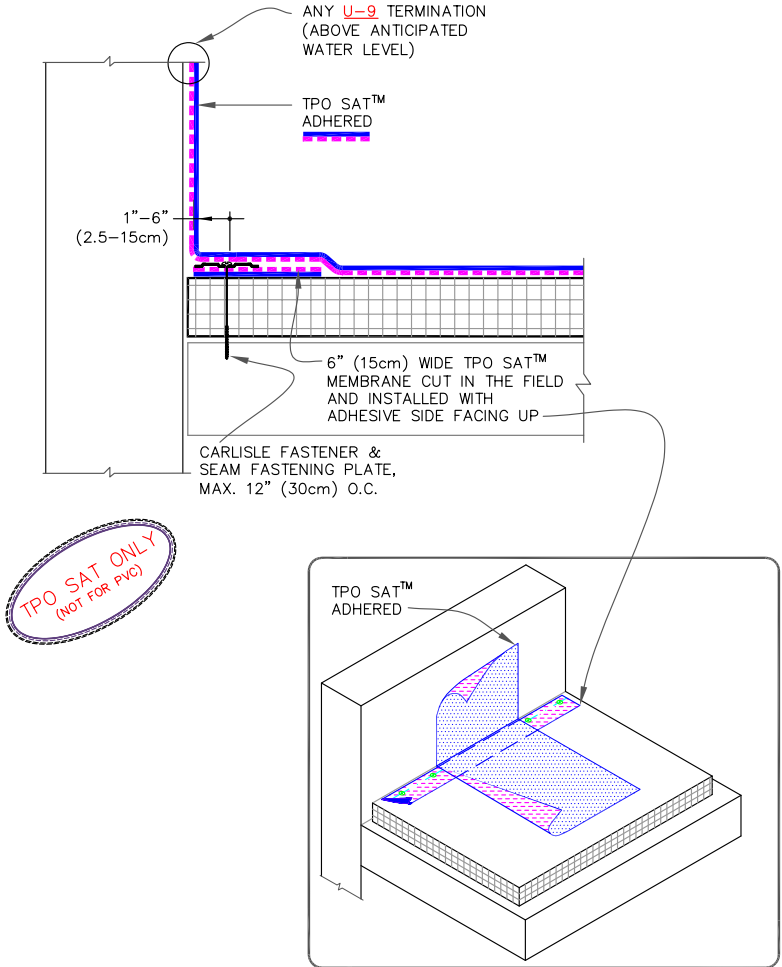

	TPO SAT PARAPET FLASHING WITH TPO SECUREMENT STRIP SAT™ (SELF ADHERING TECHNOLOGY)		DETAIL NO.
	MAXIMUM WARRANTY: 30 YEARS		U-12H
		THERMOPLASTIC TPO	

© 2023 Carlisle SynTec a division of Carlisle Construction Materials Incorporated

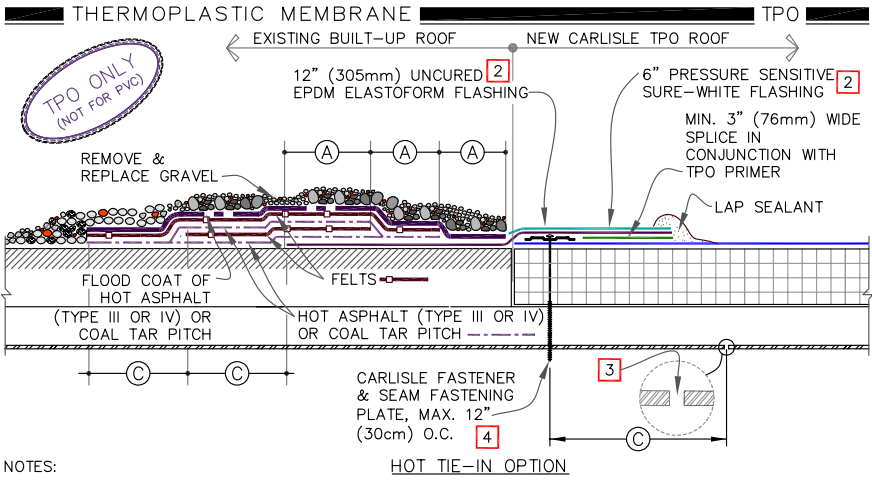

- NOTES:
1. REMOVE ALL GRAVEL AT TIE-IN.
 2. OVERLAY SURE-SEAL ELASTOFORM FLASHING WITH 6"(15cm) SURE-WHITE PRESSURE SENSITIVE FLASHING TO REDUCE HEAT GAIN ON TPO MEMBRANE
 3. IF FLUTES ARE PERPENDICULAR TO THE TIE-IN DRILL A 3/8" (1cm) DIAMETER WEEP HOLE INTO THE BOTTOM FLUTES OF THE STEEL DECK ALONG THE PERIMETER OF THE TIE-IN 6" (15cm) MINIMUM TO 12" (30cm) MAXIMUM FROM THE SEAM FASTENING PLATE.
 4. ON MECHANICALLY FASTENED SYSTEMS, HP-X FASTENERS AND PIRANHA PLATES OR HP-XTRA FASTENERS AND PIRANHA XTRA PLATES ARE REQUIRED TO BE USED FOR HOT AND/OR COLD METHOD OVER STEEL DECKS.
 5. IF WATER PONDS OR FLOWS OVER TIE-IN FROM BUR SURFACE, USE **DETAIL U-13B**.

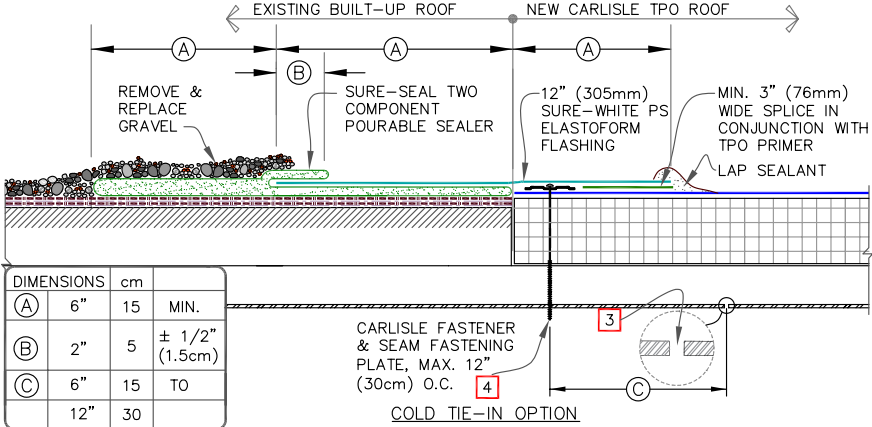

DIMENSIONS	cm	
(A)	6"	15 MIN.
(B)	2"	± 1/2" (1.5cm)
(C)	6"	15 TO
	12"	30

	TPO TIE-IN TO BUILT-UP ROOFING OVER STEEL ROOF DECK		DETAIL NO.
	MAXIMUM WARRANTY: 30 YEARS		U-13A
		THERMOPLASTIC TPO	

© 2023 Carlisle SynTec a division of Carlisle Construction Materials Incorporated

THERMOPLASTIC MEMBRANE TPO

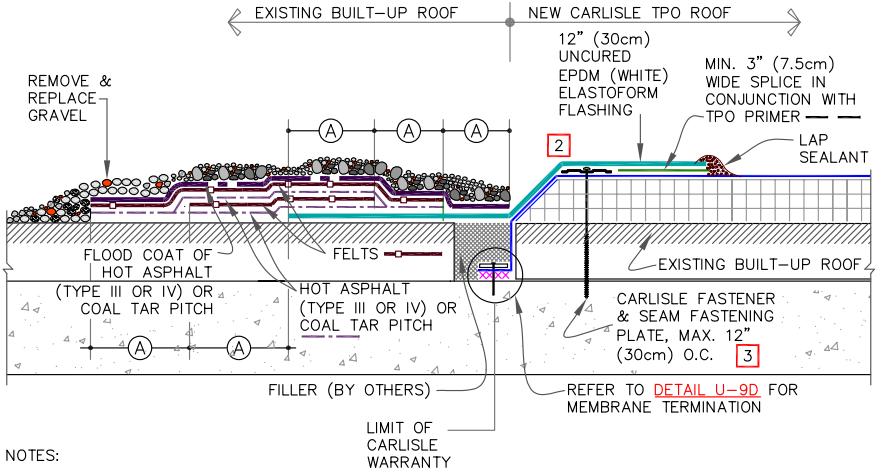

NOTES:

1. REMOVE ALL GRAVEL AT TIE-IN.
2. SPLICE TWO PIECES OF WHITE PRESSURE-SENSITIVE ELASTOFORM TO ACHIEVE DESIRED WIDTH.
3. ON MECHANICALLY FASTENED SYSTEMS, CD-10 OR HD 14-10 FASTENERS AND PIRANHA PLATES ARE REQUIRED OVER CONCRETE DECKS.
4. WATER CUT-OFF MUST BE HELD UNDER CONSTANT COMPRESSION.
5. CARLISLE IS NOT RESPONSIBLE FOR DAMAGE TO THE BUILT-UP ROOF OR STRUCTURAL DECK RESULTING FROM PONDED WATER; THIS DETAIL APPLIES TO RE-ROOFING WHEN A TEAR-OFF IS NOT SPECIFIED AND WAS DESIGNED TO PREVENT MIGRATION OF WATER WITHIN THE NEW ROOFING SYSTEM.

DIMENSIONS	cm	
(A)	6"	15 MIN.
(B)	2"	5 ± 1/2" (1.5cm)

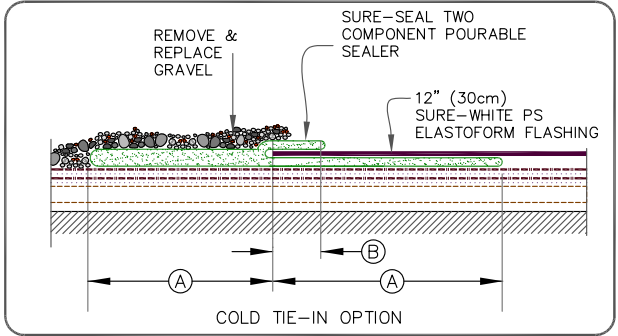

	TPO TIE-IN TO BUILT-UP ROOFING OVER CONCRETE ROOF DECK		DETAIL NO.
	MAXIMUM WARRANTY: 30 YEARS		U-13B
		THERMOPLASTIC TPO	

THERMOPLASTIC MEMBRANE

PVC/TPO

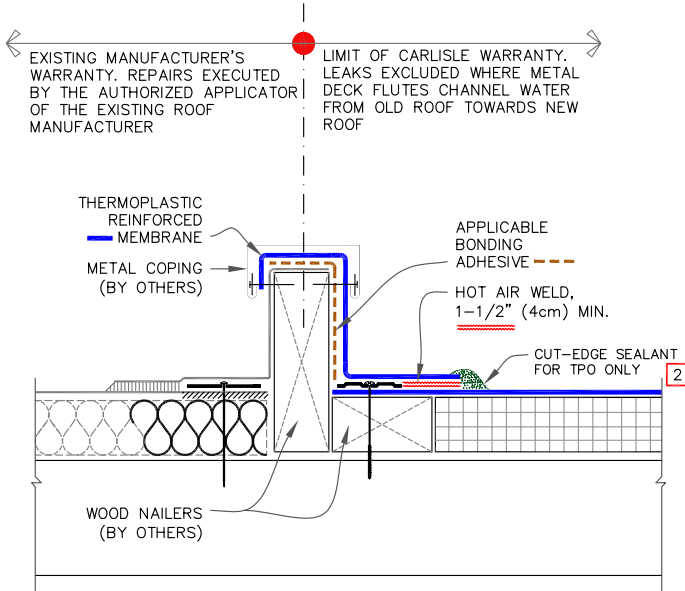

NOTES:

1. POSITION MEMBRANE FASTENING PLATES 1/2" (1.5cm) TO 1" (2.5cm) FROM EDGE OF DECK MEMBRANE.
2. APPROXIMATELY 1/8" (0.5cm) DIAMETER BEAD OF CUT-EDGE SEALANT IS REQUIRED ON CUT EDGES OF REINFORCED TPO MEMBRANE.
3. ENSURE THE LOCATION OF CURB WILL NOT IMPEDE THE FLOW OF WATER AT EXISTING ADJACENT ROOF.

	TPO/PVC TIE-IN TO EXISTING SINGLE-PLY		DETAIL NO.
	MAXIMUM WARRANTY: 30 YEARS		U-13C
		THERMOPLASTIC UNIVERSAL	

© 2023 Carlisle SynTec a division of Carlisle Construction Materials Incorporated

■■■■ THERMOPLASTIC MEMBRANE ■■■■ TPO ■■■■

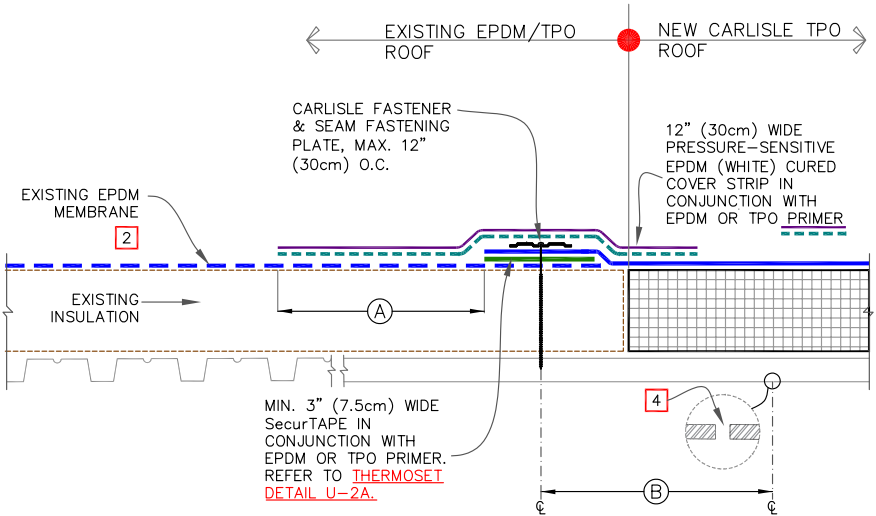

DIMENSIONS	cm	
(A)	6"	15
(B)	6"	15 MIN.
	12"	30 MAX.

NOTES:

1. PRIOR TO SPLICING, CLEAN EXISTING EPDM MEMBRANE BY SCRUBBING THE SPLICE AREA WITH WEATHERED MEMBRANE CLEANER AND ALLOW TO DRY.
2. CONTACT MANUFACTURER OF EXISTING WARRANTED EPDM MEMBRANE ROOFING SYSTEM TO VERIFY ACCEPTANCE OF TIE-IN.
3. FOR EXISTING BALLASTED SYSTEMS BY OTHERS, CONSULT RESPECTIVE MANUFACTURER FOR ACCEPTABLE GRAVEL CONTAINMENT TO PREVENT GRAVEL MIGRATION.
4. IF FLUTES ARE PERPENDICULAR DRILL A 3/8" (1cm) DIAMETER WEEP HOLE INTO THE BOTTOM FLUTES OF THE STEEL DECK ALONG THE PERIMETER OF THE TIE-IN 6" (15cm) MINIMUM TO 12" (30cm) MAXIMUM FROM THE SEAM FASTENING PLATE.
5. ON MECHANICALLY FASTENED SYSTEMS, HP-X FASTENERS AND PIRANHA PLATES OR HP-XTRA FASTENERS AND PIRANHA XTRA PLATES ARE REQUIRED OVER STEEL DECKS.



	TPO TIE-IN TO EXISTING EPDM MEMBRANE		DETAIL NO.
	MAXIMUM WARRANTY: 30 YEARS		U-13D
		THERMOPLASTIC TPO	

© 2023 Carlisle SynTec a division of Carlisle Construction Materials Incorporated

■■■■ THERMOPLASTIC MEMBRANE ■■■■ TPO ■■■■

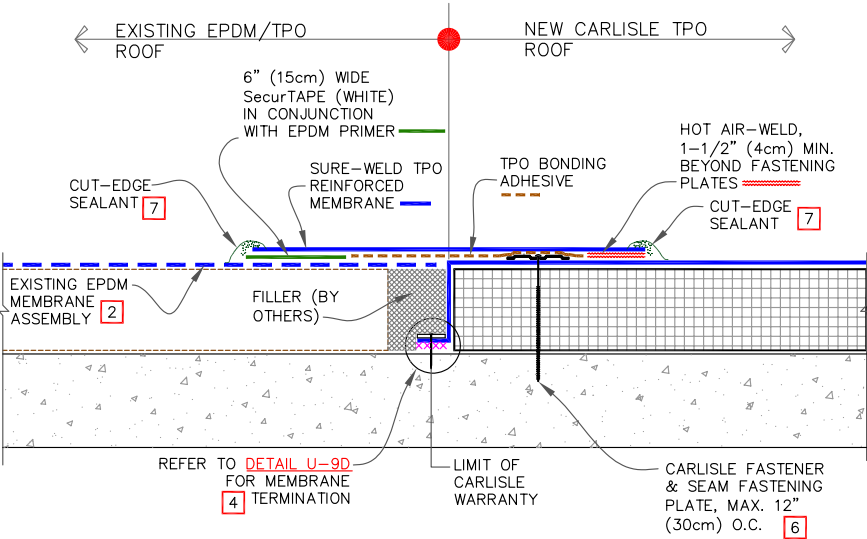

NOTES:

1. PRIOR TO SPLICING, CLEAN EXISTING EPDM MEMBRANE BY SCRUBBING THE SPLICE AREA WITH WEATHERED MEMBRANE CLEANER AND ALLOW TO DRY.
2. CONTACT MANUFACTURER OF EXISTING WARRANTED EPDM MEMBRANE ROOFING SYSTEM TO VERIFY ACCEPTANCE OF TIE-IN.
3. ON EXISTING BALLASTED SYSTEMS, CONSULT RESPECTIVE MANUFACTURER FOR ACCEPTABLE GRAVEL CONTAINMENT TO PREVENT GRAVEL MIGRATION.
4. WATER CUT-OFF MASTIC MUST BE HELD UNDER CONSTANT COMPRESSION.
5. WHEN RE-ROOFING OVER PRE-CAST CONCRETE, APPLY LIBERAL BEAD OF WATER CUT-OFF MASTIC IN THE JOINTS TO PREVENT MOISTURE MIGRATION.
6. ON MECHANICALLY FASTENED SYSTEMS, CD-10 OR HD 14-10 FASTENERS AND PIRANHA PLATES ARE REQUIRED OVER CONCRETE DECKS.
7. APPROXIMATELY 1/8" (0.5cm) DIAMETER BEAD OF CUT-EDGE SEALANT IS REQUIRED ON CUT EDGES OF REINFORCED TPO MEMBRANE.

TPO ONLY
(NOT FOR PVC)

	EPDM TIE-IN ON CONCRETE DECK		DETAIL NO.
	MAXIMUM WARRANTY: 30 YEARS		U-13E
		THERMOPLASTIC TPO	

© 2023 Carlisle SynTec a division of Carlisle Construction Materials Incorporated

■ THERMOPLASTIC MEMBRANE ■ PVC/TPO ■

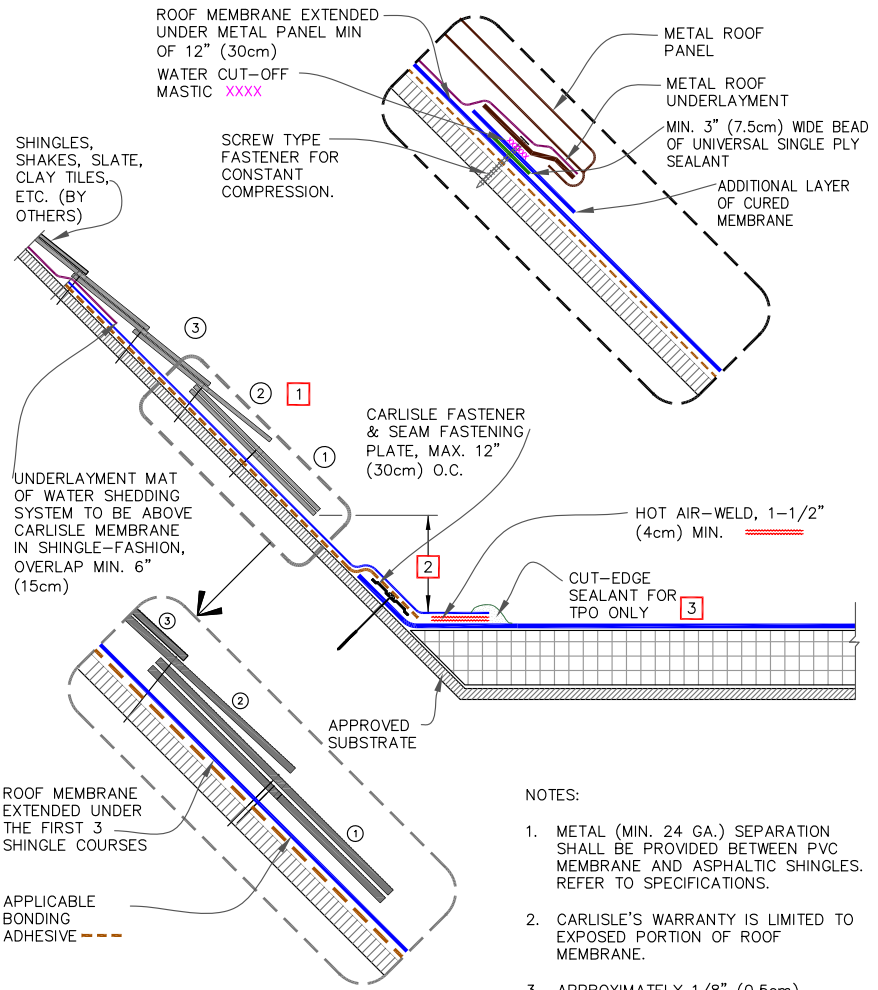

NOTES:

1. METAL (MIN. 24 GA.) SEPARATION SHALL BE PROVIDED BETWEEN PVC MEMBRANE AND ASPHALTIC SHINGLES. REFER TO SPECIFICATIONS.
2. CARLISLE'S WARRANTY IS LIMITED TO EXPOSED PORTION OF ROOF MEMBRANE.
3. APPROXIMATELY 1/8" (0.5cm) DIAMETER BEAD OF CUT-EDGE SEALANT IS REQUIRED ON CUT EDGES OF REINFORCED TPO MEMBRANE.

	TPO/PVC TIE-IN TO SHINGLED OR METAL PANEL ROOF		DETAIL NO.
	MAXIMUM WARRANTY: 30 YEARS		U-13F
		THERMOPLASTIC UNIVERSAL	

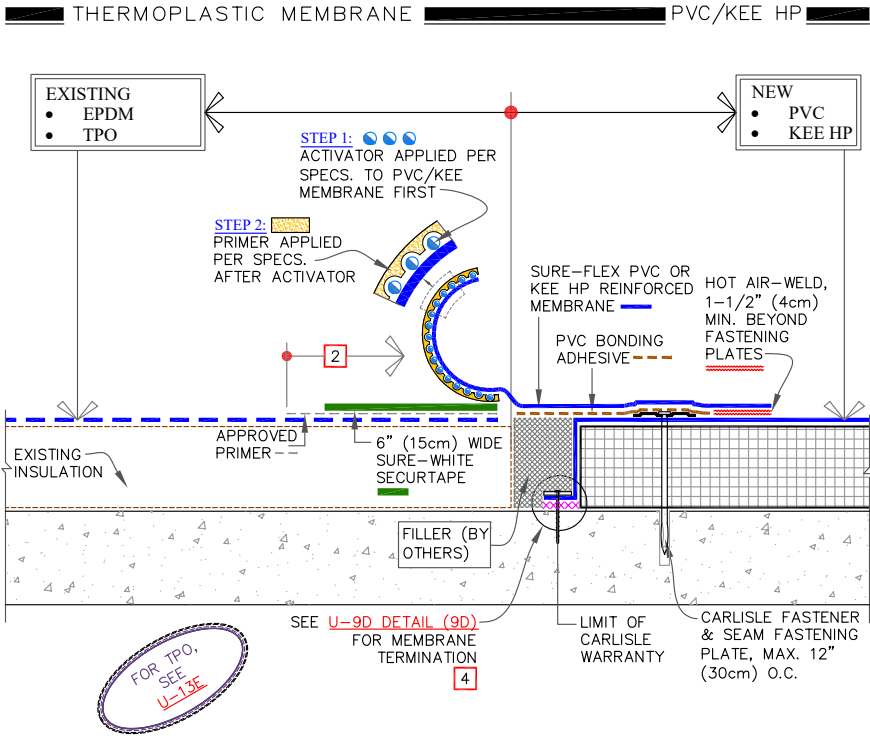

NOTES:

- ON EXISTING WARRANTED ROOFS, SEEK WRITTEN APPROVAL OF ITS MANUFACTURER FOR ACCEPTANCE OF THIS DETAIL. FOR EXISTING BALLASTED SYSTEMS BY OTHERS, CONSULT RESPECTIVE MANUFACTURER FOR ACCEPTABLE GRAVEL CONTAINMENT TO PREVENT GRAVEL MIGRATION.
- EXISTING EPDM/TPO MEMBRANES:** CLEAN THE SEAMING AREA WITH WEATHERED MEMBRANE CLEANER AND ALLOW TO DRY. APPLY APPROVED PRIMER.
EXISTING PVC OR KEE MEMBRANES: IF EXISTING MEMBRANE IS NOT ACCEPTABLE FOR WELDING, UTILIZE STEP 1 ACTIVATOR AND STEP 2 PRIMER PROCESS.
- WHEN USING 80-MIL PVC/KEE HP REINFORCED THERMOPLASTIC MEMBRANE, APPLY A 4-1/2" (11cm) DIAMETER THERMOPLASTIC T-JOINT COVER AT ALL FIELD SPLICE INTERSECTIONS.
- WATER CUT-OFF MASTIC MUST BE HELD UNDER CONSTANT COMPRESSION. WHEN RE-ROOFING OVER PRECAST CONCRETE, APPLY LIBERAL BEAD OF WATER CUT-OFF MASTIC IN JOINTS TO PREVENT MOISTURE MIGRATION.

	PVC/KEE HP TIE-IN TO EXISTING SINGLE-PLY ROOF MEMBRANES ON CONCRETE DECK		DETAIL NO.
	MAXIMUM WARRANTY: 20 YEARS		U-13G
		THERMOPLASTIC PVC	

© 2023 Carlisle SynTec a division of Carlisle Construction Materials Incorporated

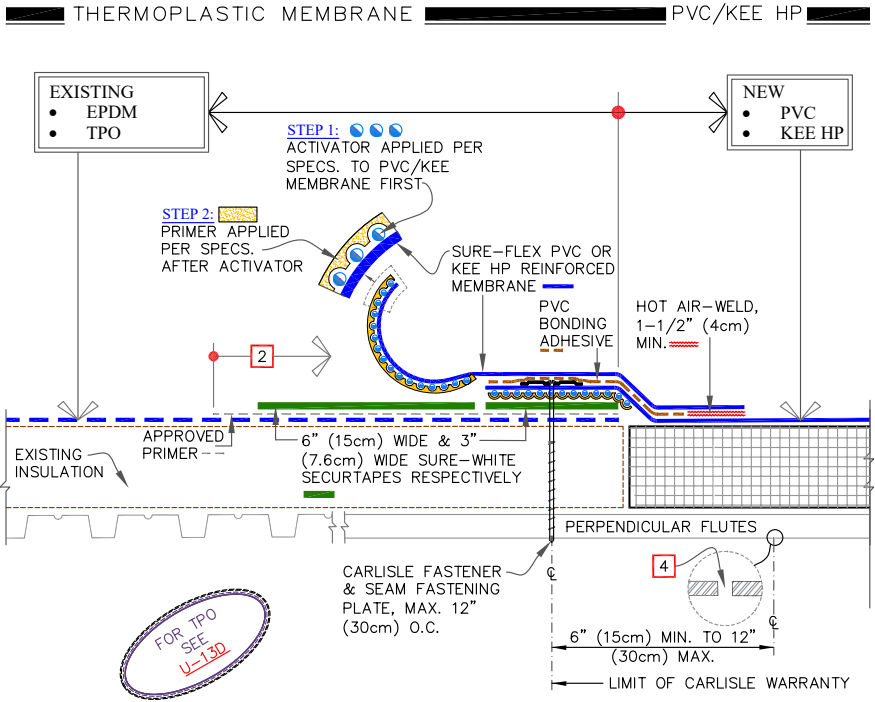

NOTES:

1. ON EXISTING WARRANTED ROOFS, SEEK WRITTEN APPROVAL OF ITS MANUFACTURER FOR ACCEPTANCE OF THIS DETAIL. FOR EXISTING BALLASTED SYSTEMS BY OTHERS, CONSULT RESPECTIVE MANUFACTURER FOR ACCEPTABLE GRAVEL CONTAINMENT TO PREVENT GRAVEL MIGRATION.

2. **EXISTING EPDM/TPO MEMBRANES:** CLEAN THE SEAMING AREA WITH WEATHERED MEMBRANE CLEANER AND ALLOW TO DRY. APPLY APPROVED PRIMER.

EXISTING PVC OR KEE MEMBRANES: IF EXISTING MEMBRANE IS NOT ACCEPTABLE FOR WELDING, UTILIZE STEP 1 ACTIVATOR AND STEP 2 PRIMER PROCESS.

3. WHEN USING 80-MIL PVC/KEE HP REINFORCED THERMOPLASTIC MEMBRANE, APPLY A 4-1/2" (11cm) DIAMETER THERMOPLASTIC T-JOINT COVER AT ALL FIELD SPLICE INTERSECTIONS.
4. IF FLUTES ARE PERPENDICULAR, DRILL 3/8" (1cm) DIAMETER WEEP HOLES INTO THE BOTTOM FLUTES OF THE STEEL DECK ALONG THE TIE-IN.

	PVC/KEE HP TIE-IN TO EXISTING SINGLE-PLY ROOF MEMBRANES ON METAL DECK		DETAIL NO.
	MAXIMUM WARRANTY: 20 YEARS		U-13H
		THERMOPLASTIC PVC	

© 2023 Carlisle SynTec a division of Carlisle Construction Materials Incorporated

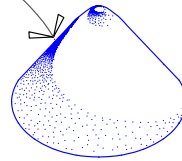
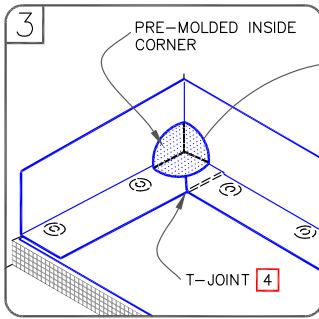
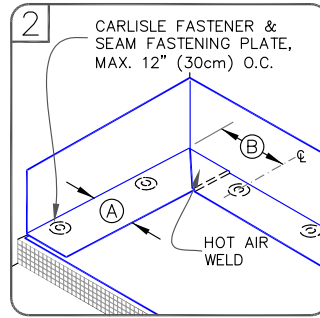
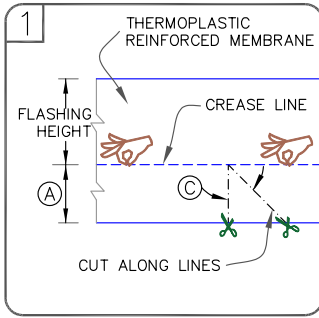

PRE-MOLDED INSIDE CORNER BEFORE INSTALLATION

NOTES:

1. POSITION FASTENING PLATES 6" TO 9" (15 TO 23cm) FROM THE CORNER AND 1/2" TO 1" (1.5 TO 2.5cm) FROM EDGE OF MEMBRANE.
2. APPROXIMATELY 1/8" (0.5cm) DIAMETER BEAD OF CUT-EDGE SEALANT IS REQUIRED ON CUT EDGES OF REINFORCED TPO MEMBRANE.
3. REFER TO CARLISLE SPECIFICATIONS FOR ACCEPTABLE CARLISLE FASTENERS AND PLATES.
4. WHEN USING 60-MIL TPO OR 80-MIL TPO OR PVC MEMBRANE, APPLY A 4-1/2" (11.5cm) DIAMETER "T-JOINT" COVER AT ALL FIELD SPLICE INTERSECTIONS.

DIMENSIONS	cm		
(A)	6"	15	APPROX.
(B)	6"-9"	15-23	
(C)	45-DEGREES APPROX.		



PRE-MOLDED INSIDE CORNER FLASHING

MAXIMUM WARRANTY: 30 YEARS



DETAIL NO.

U-15A

THERMOPLASTIC UNIVERSAL

THERMOPLASTIC MEMBRANE

PVC/TPO

CAUTION

DETAIL NOT FOR USE ON 25 OR 30-YEAR WARRANTY PROJECTS, PRE-FABRICATED/PRE-MOLDED ACCESSORIES MUST BE UTILIZED. ACCEPTABLE FLASHING SHALL CONFORM WITH THERMOPLASTIC UNIVERSAL DETAIL U-15A OR U-15G.

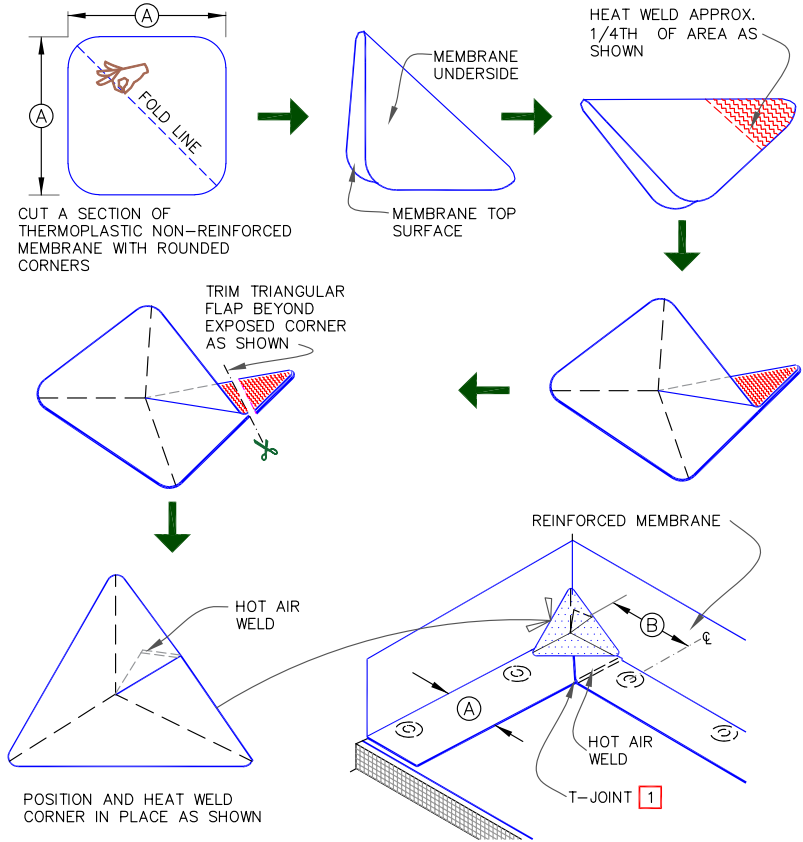

DIMENSIONS	cm		
(A)	6"	15	APPROX.
(B)	6"-9"	15-23	

NOTE:

WHEN USING 60 OR 80-MIL MEMBRANE, APPLY A 4 1/2" (11cm) DIAMETER "T-JOINT" COVER AT ALL FIELD SPLICE INTERSECTIONS.

	FIELD FABRICATED INSIDE CORNER FLASHING	DETAIL NO. U-15B THERMOPLASTIC UNIVERSAL
	MAXIMUM WARRANTY: 20 YEARS	

© 2023 Carlisle SynTec a division of Carlisle Construction Materials Incorporated

THERMOPLASTIC MEMBRANE

PVC/TPO

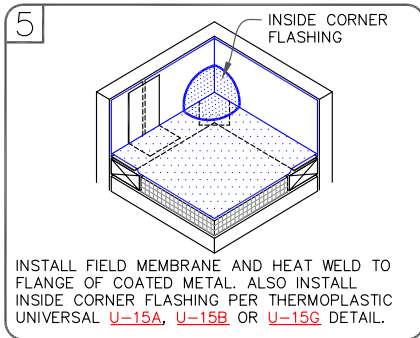
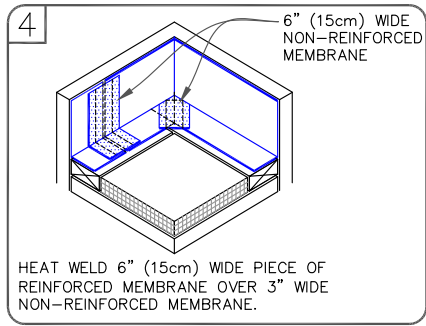
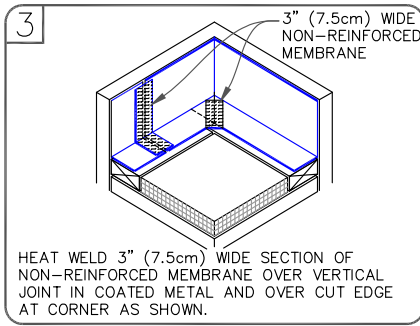
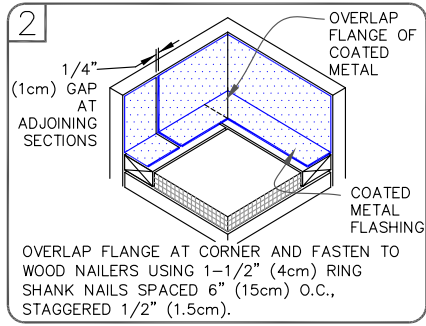
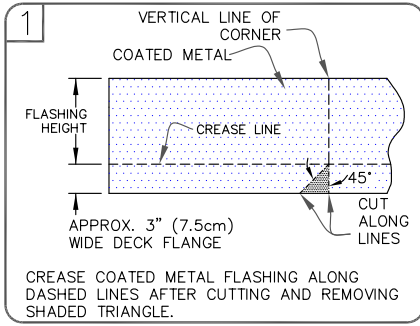

NOTES:

1. FASTEN COATED METAL FLASHING TO WOOD NAILERS USING 1-1/2" (4cm) MIN. RING SHANK NAILS SPACED 6" (15cm) ON CENTER AND STAGGERED APPROX. 1/2" (1.5cm).
2. APPROXIMATELY 1/8" (0.5cm) DIAMETER BEAD OF CUT-EDGE SEALANT IS REQUIRED ON CUT EDGES OF REINFORCED TPO MEMBRANE.

	INSIDE CORNER WITH COATED METAL WALL FLASHING		DETAIL NO.
	MAXIMUM WARRANTY: 30 YEARS		U-15C
		THERMOPLASTIC UNIVERSAL	

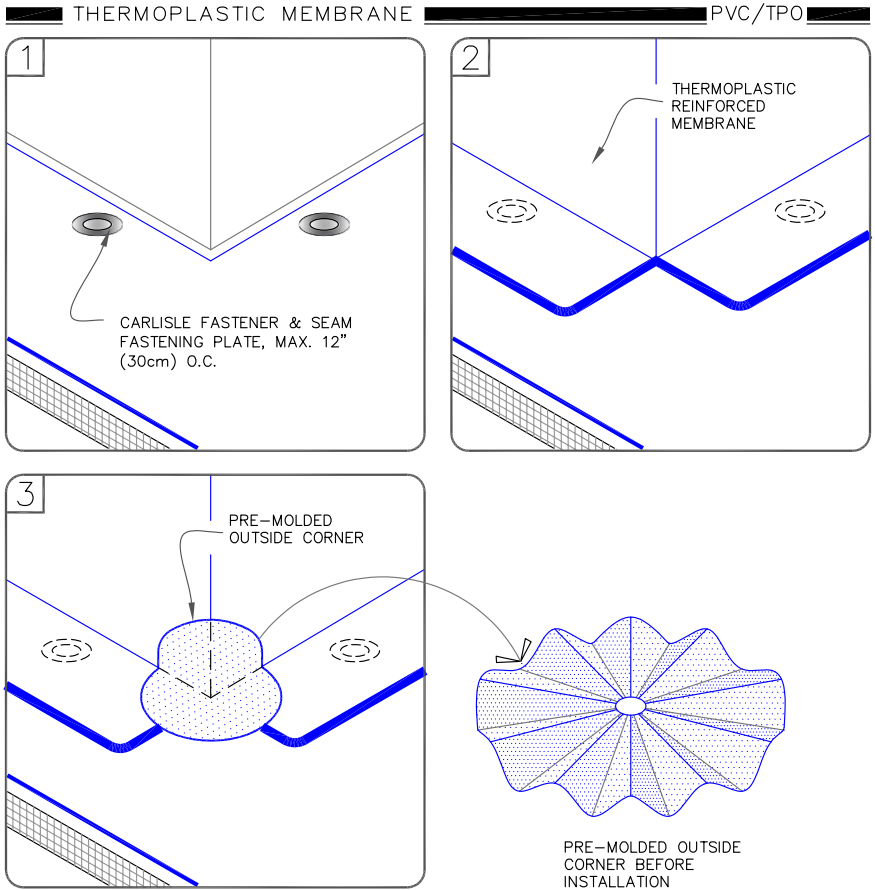

NOTES:

1. POSITION FASTENING PLATES 6"(15cm) FROM THE CORNER AND 1/2" TO 1" (1.5 TO 2.5cm) FROM EDGE OF MEMBRANE.
2. APPROXIMATELY 1/8" (0.5cm) DIAMETER BEAD OF CUT-EDGE SEALANT IS REQUIRED ON CUT EDGES OF REINFORCED TPO MEMBRANE.
3. REFER TO CARLISLE SPECIFICATIONS FOR ACCEPTABLE CARLISLE FASTENERS AND PLATES.

	PRE-MOLDED OUTSIDE CORNER FLASHING		DETAIL NO.
	MAXIMUM WARRANTY: 30 YEARS		U-15D
		THERMOPLASTIC UNIVERSAL	

© 2023 Carlisle SynTec a division of Carlisle Construction Materials Incorporated

THERMOPLASTIC MEMBRANE

PVC/TPO

CAUTION

DETAIL NOT FOR USE ON 25 OR 30-YEAR WARRANTY PROJECTS, PRE-FABRICATED/PRE-MOLDED ACCESSORIES MUST BE UTILIZED. ACCEPTABLE FLASHING SHALL CONFORM WITH THERMOPLASTIC UNIVERSAL DETAIL [U-15D](#) OR [U-15G](#).

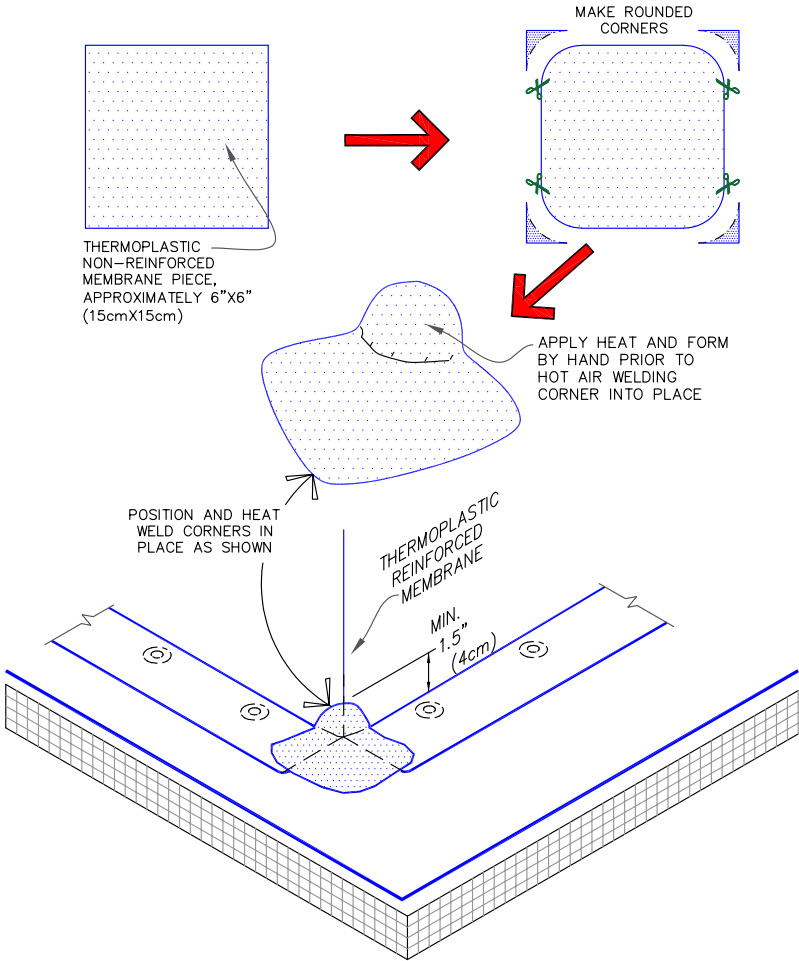

	FIELD FABRICATED OUTSIDE CORNER FLASHING		DETAIL NO.
	MAXIMUM WARRANTY: 20 YEARS		U-15E
		THERMOPLASTIC UNIVERSAL	

© 2023 Carlisle SynTec a division of Carlisle Construction Materials Incorporated

THERMOPLASTIC MEMBRANE

PVC/TPO

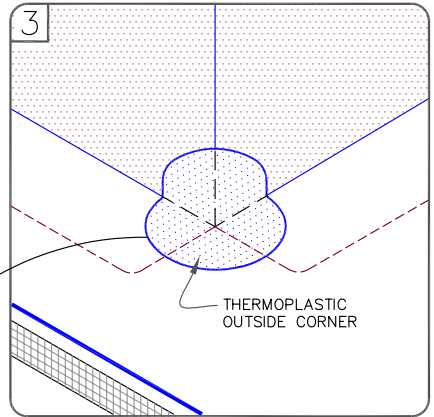
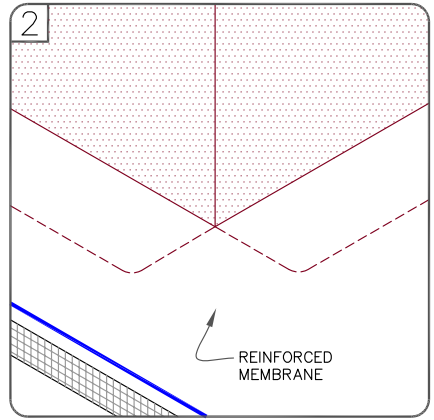
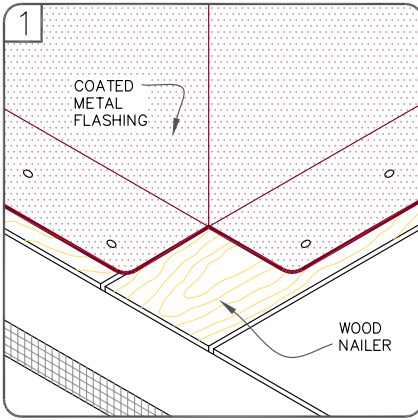

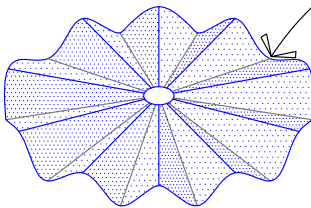

NOTES:

1. FASTEN COATED METAL FLASHING TO WOOD NAILERS USING 1-1/2" (4cm) MIN. RING SHANK NAILS SPACED 6" (15cm) ON CENTER AND STAGGERED APPROX. 1/2" (1.5cm).
2. REFER TO THERMOPLASTIC **U-5B** DETAIL FOR FLASHING VERTICAL JOINTS IN COATED METAL.



OUTSIDE CORNER BEFORE INSTALLATION

	OUTSIDE CORNER WITH COATED METAL WALL FLASHING		DETAIL NO.
	MAXIMUM WARRANTY: 30 YEARS		U-15F
		THERMOPLASTIC UNIVERSAL	

© 2023 Carlisle SynTec a division of Carlisle Construction Materials Incorporated

THERMOPLASTIC MEMBRANE

PVC/TPO

60-MIL THICK PVC/TPO,
UNIVERSAL CORNERS CAN
BE USED FOR 3 DIFFERENT
CORNER CONDITIONS AS
SHOWN BELOW

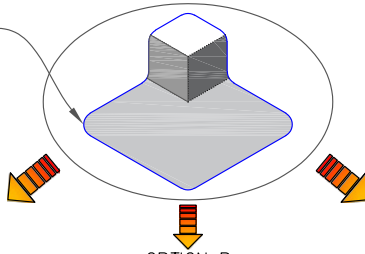

OPTION A

OPTION B

OPTION C

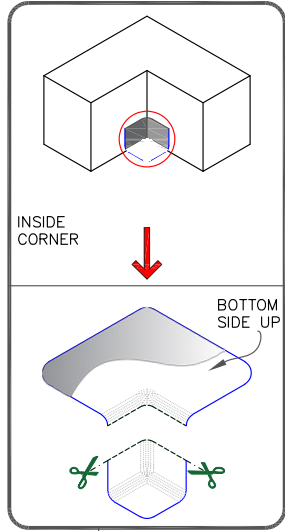
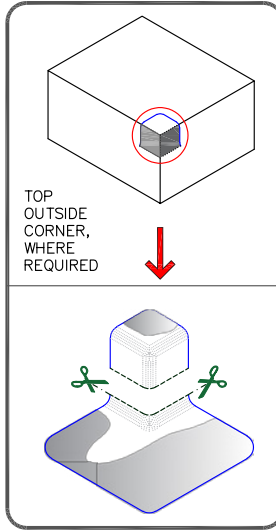
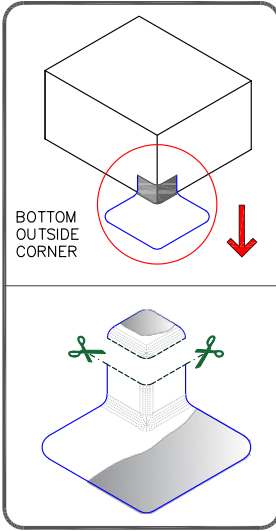

NOTES:

1. ROOF SYSTEMS MUST NOT HAVE FIELD FABRICATED OR BUILT-IN CANT STRIP.
2. REFER TO TECHNICAL DATA BULLETINS FOR COLOR AVAILABILITY.

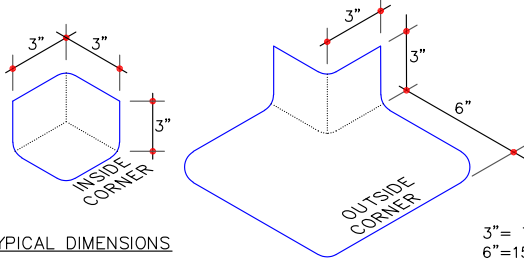

TYPICAL DIMENSIONS

3" = 7.5cm
6" = 15cm

	PVC OR TPO: UNIVERSAL CORNERS – COMBINATION INSIDE & OUTSIDE CORNERS		DETAIL NO.
	MAXIMUM WARRANTY: 30 YEARS		U-15G
		THERMOPLASTIC UNIVERSAL	

THERMOPLASTIC MEMBRANE

PVC/TPO

CAUTION

MOLDED SEALANT POCKETS MUST BE USED IN CONJUNCTION WITH RAIN HOODS FOR PROJECTS WITH 25 AND 30-YEAR WARRANTIES.

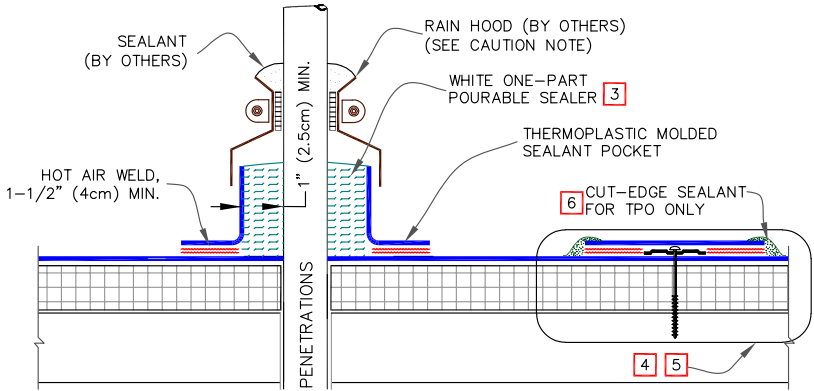

NOTES:

1. TEMPERATURE OF PIPE MUST NOT EXCEED 160° F (71° C).
2. WHEN USING TPO MOLDED SEALANT POCKET, TPO PRIMER MUST BE APPLIED TO ALL INSIDE SURFACES AND PENETRATIONS PRIOR TO FILLING WITH SEALANT. WHEN USING PVC MOLDED SEALANT POCKET, CLEAN THE POCKET WITH PVC AND KEE HP CLEANER, APPLY TPO PRIMER TO PENETRATION(S) ONLY.
3. FILL POCKET COMPLETELY WITH WHITE ONE-PART POURABLE SEALER UNTIL RIM IS COVERED WITH SEALANT; ENSURE ALL VOIDS ARE FILLED.
4. ON MECHANICALLY-FASTENED SYSTEMS, INSTALL A MINIMUM OF 4 FASTENING PLATES AROUND SEALANT POCKETS WITH A DIAMETER UP TO 6" (15cm). ADDITIONAL FASTENING PLATES WILL BE REQUIRED FOR SEALANT POCKETS GREATER THAN 6" IN DIAMETER AND SHALL BE SPACED 12" (30cm) ON CENTER MAXIMUM.
5. REFER TO CARLISLE SPECIFICATIONS FOR PROPER FASTENERS AND PLATES.
6. APPROXIMATELY 1/8" (0.5cm) DIAMETER BEAD OF CUT-EDGE SEALANT IS REQUIRED ON CUT EDGES OF REINFORCED TPO MEMBRANE.

PLACE MOLDED THERMOPLASTIC SEALANT POCKET AROUND PENETRATION AND OVERLAP THE TWO SECTIONS

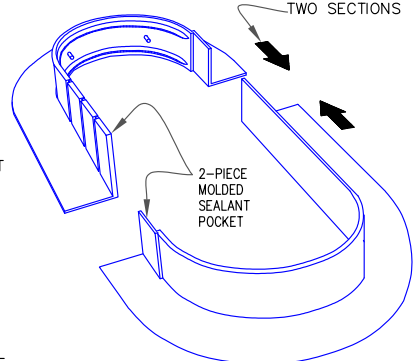

REFER TO PRODUCT DATA SHEET FOR STEP-BY-STEP INSTALLATION PROCEDURES

	MOLDED SEALANT POCKET		DETAIL NO.
	MAXIMUM WARRANTY: 30 YEARS		U-16A
		THERMOPLASTIC UNIVERSAL	

© 2023 Carlisle SynTec a division of Carlisle Construction Materials Incorporated

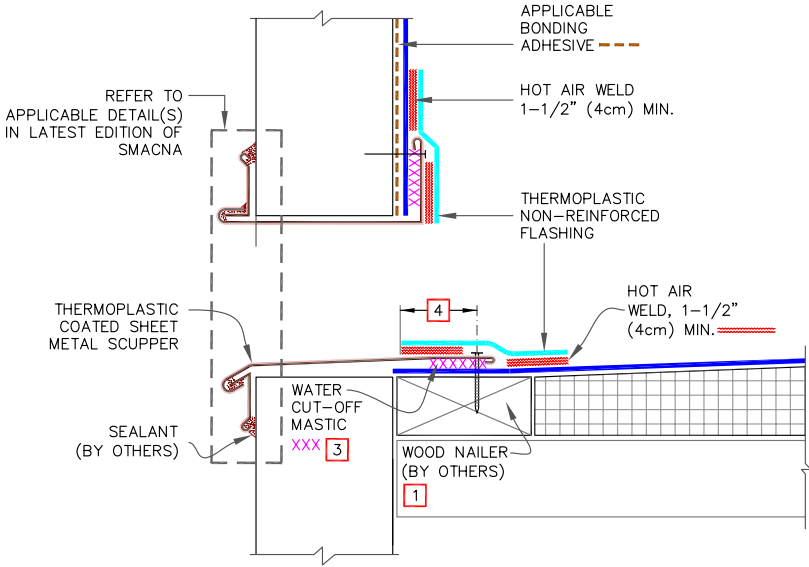

NOTES:

1. WOOD NAILERS ARE INSTALLED AT SCUPPERS TO SECURE METAL SLEEVE AND MUST EXTEND PAST THE WIDTH OF METAL SLEEVE FLANGE.
2. METAL SCUPPER BOX MUST HAVE CONTINUOUS FLANGES WITH ROUNDED CORNERS. SOLDER ALL SCUPPER SEAMS WATER-TIGHT.
3. WATER CUT-OFF MASTIC UNDER SCUPPER FLANGES MUST BE UNDER CONSTANT COMPRESSION.
4. SCUPPER FLANGES MUST BE TOTALLY COVERED BY NON-REINFORCED FLASHING WITH MINIMUM 2" (5cm) COVERAGE PAST NAIL HEAD.

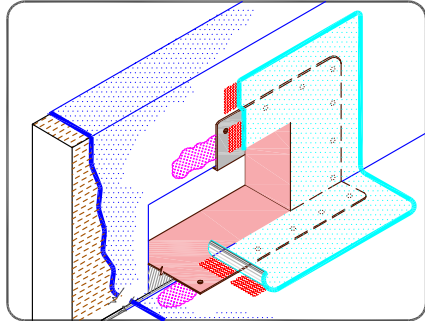

	SCUPPER WITH COATED METAL		DETAIL NO.
	MAXIMUM WARRANTY: 30 YEARS		U-18A
		THERMOPLASTIC UNIVERSAL	

© 2023 Carlisle SynTec a division of Carlisle Construction Materials Incorporated

— THERMOPLASTIC MEMBRANE — TPO —

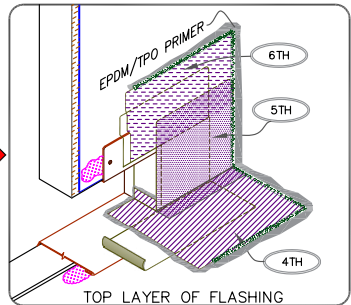
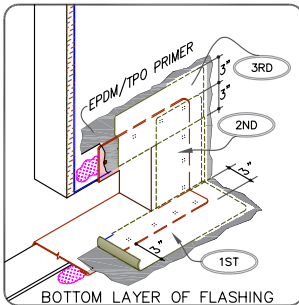
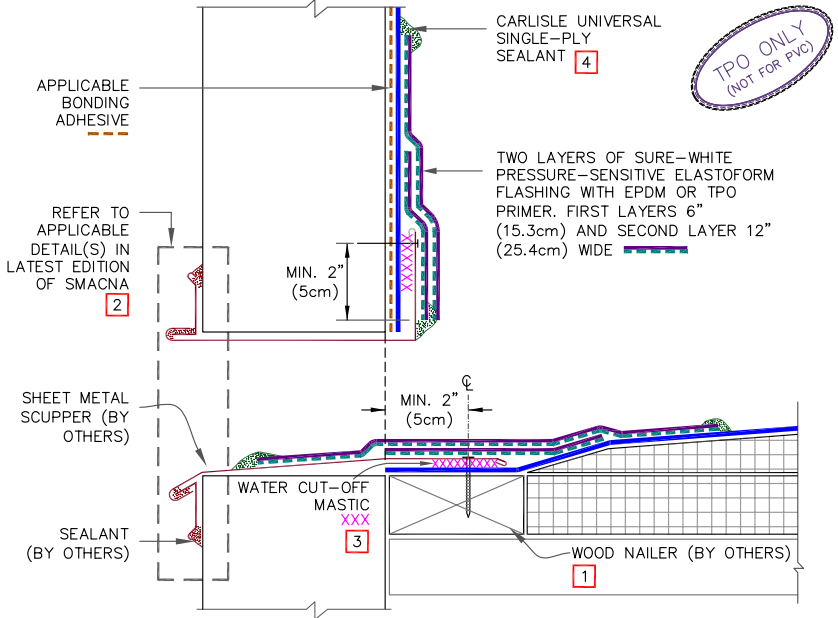

NOTES:

1. WOOD NAILERS ARE INSTALLED AT SCUPPERS TO SECURE METAL SLEEVE AND MUST EXTEND PAST THE WIDTH OF METAL SLEEVE FLANGE.
2. METAL SCUPPER BOX MUST HAVE CONTINUOUS FLANGES WITH ROUNDED CORNERS, SOLDER ALL SCUPPER SEAMS WATER-TIGHT.
3. WATER CUT-OFF MASTIC UNDER SCUPPER FLANGES MUST BE UNDER CONSTANT COMPRESSION.
4. UNIVERSAL SINGLE-PLY SEALANT IS REQUIRED AT FLASHING EDGES ON SCUPPER EDGE. TPO PRIMER MUST BE USED TO PREPARE SURFACES PRIOR TO THE APPLICATION OF SEALANT.

	SCUPPER AT DECK – TPO		DETAIL NO.
	MAXIMUM WARRANTY: 30 YEARS		U-18B
		THERMOPLASTIC TPO	

THERMOPLASTIC MEMBRANE

PVC/KEE HP

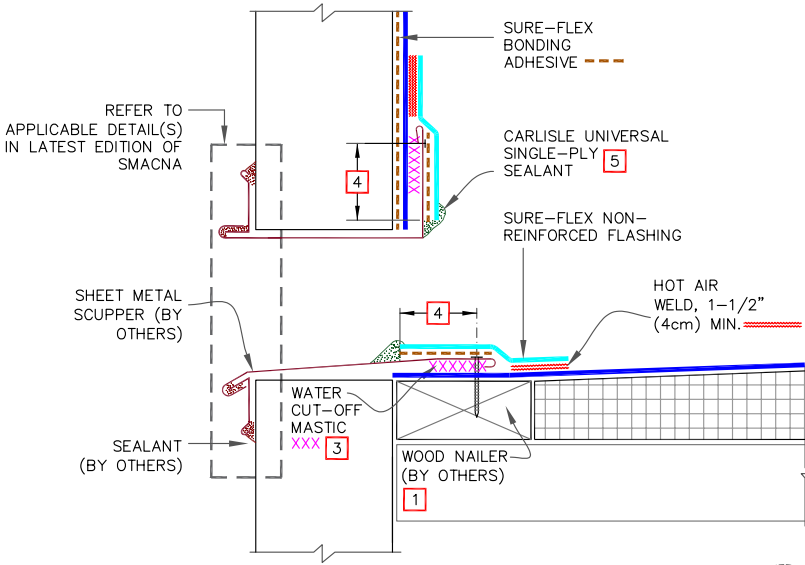

NOTES:

1. WOOD NAILERS ARE INSTALLED ONLY AT SCUPPERS TO SECURE METAL SLEEVE AND MUST EXTEND PAST THE WIDTH OF METAL SLEEVE FLANGE.
2. METAL SCUPPER BOX MUST HAVE CONTINUOUS FLANGES WITH ROUNDED CORNERS, SOLDER ALL SCUPPER SEAMS WATER-TIGHT.
3. WATER CUT-OFF MASTIC UNDER SCUPPER FLANGE MUST BE UNDER CONSTANT COMPRESSION.
4. SCUPPER FLANGES MUST BE TOTALLY COVERED BY NON-REINFORCED PVC/KEE HP FLASHING WITH MINIMUM 2" (5cm) COVERAGE PAST NAIL HEAD.
5. UNIVERSAL SINGLE-PLY SEALANT IS REQUIRED AT FLASHING EDGES ON SCUPPER EDGE.

PVC/
KEE HP ONLY.
(NOT FOR TPO)

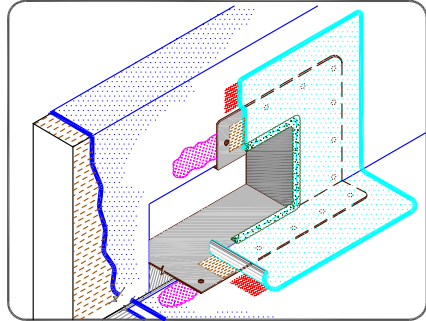

	SCUPPER WITH SURE-FLEX NON-REINFORCED PVC/KEE HP FLASHING		DETAIL NO.
	MAXIMUM WARRANTY: 30 YEARS		U-18C
		THERMOPLASTIC PVC	

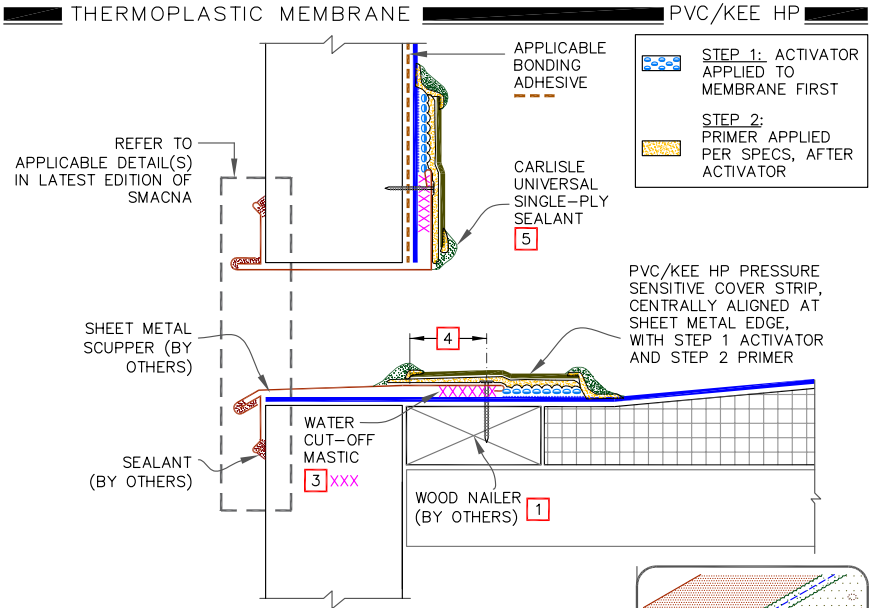

NOTES:

- WOOD NAILERS ARE INSTALLED ONLY AT SCUPPERS TO SECURE METAL SLEEVE AND MUST EXTEND PAST THE WIDTH OF METAL SLEEVE FLANGE.
- METAL SCUPPER BOX MUST HAVE CONTINUOUS FLANGES WITH ROUNDED CORNERS, SOLDER ALL SCUPPER SEAMS WATER-TIGHT.
- WATER CUT-OFF MASTIC UNDER SCUPPER FLANGE MUST BE UNDER CONSTANT COMPRESSION.
- PRESSURE SENSITIVE COVER STRIP MUST EXTEND A MINIMUM 2" (5cm) COVERAGE PAST NAIL HEAD.
- UNIVERSAL SINGLE-PLY SEALANT IS REQUIRED AT FLASHING EDGES ON SCUPPER EDGE. PVC STEP 2 PRIMER MUST BE USED TO PREPARE SURFACES PRIOR TO THE APPLICATION OF SEALANT.

PVC/KEE HP ONLY.
(NOT FOR TPO)

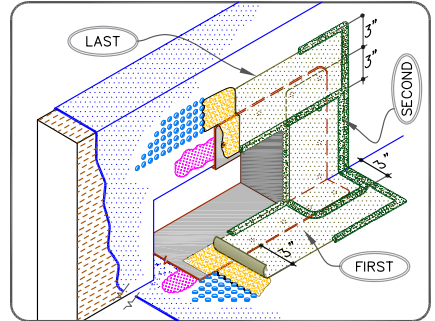
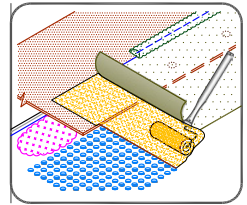

	SCUPPER WITH SURE-FLEX PVC/KEE HP PS COVER STRIP FLASHING		DETAIL NO.
	MAXIMUM WARRANTY: 20 YEARS		U-18D THERMOPLASTIC PVC

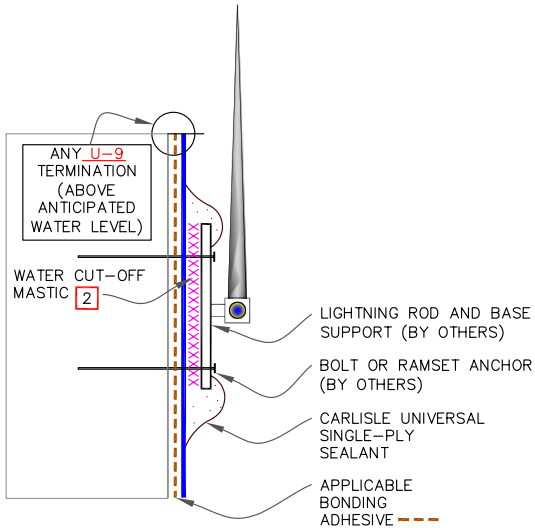

NOTES:

1. DETAIL MAY BE USED FOR ANY FASTENER PENETRATION (E.G., ACCESS LADDER, ANCHOR SUPPORT TO PARAPET).
2. WATER CUT-OFF MASTIC MUST BE UNDER CONSTANT COMPRESSION.
3. DETAIL UNACCEPTABLE FOR HORIZONTAL APPLICATION ON ROOF DECK.
4. COMPLY WITH ZONING ORDINANCE AND LOCAL CODES FOR MOUNTING A LIGHTNING SYSTEM.

	LIGHTNING ROD AT PARAPET (VERTICAL ATTACHMENT)		DETAIL NO.
	MAXIMUM WARRANTY: 30 YEARS		U-20A
		THERMOPLASTIC UNIVERSAL	

■■■■ THERMOPLASTIC MEMBRANE ■■■■ PVC/TPO ■■■■

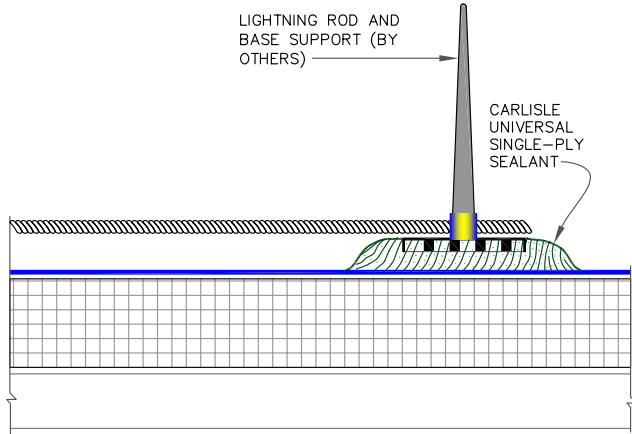

NOTES:

1. CLEAN EXPOSED MEMBRANE SURFACE WITH WEATHERED MEMBRANE CLEANER (WHEN USING TPO) AND PVC MEMBRANE CLEANER (WHEN USING PVC OR KEE HP) AND ALLOW TO DRY.
2. WHEN USING TPO MEMBRANE, APPLY TPO PRIMER TO THE MEMBRANE SURFACE PRIOR TO THE APPLICATION OF UNIVERSAL SINGLE-PLY SEALANT.
3. COMPLY WITH ZONING ORDANCE AND LOCAL CODES FOR MOUNTING A LIGHTNING SYSTEM.

	LIGHTNING ROD AT DECK LEVEL		DETAIL NO.
	MAXIMUM WARRANTY: 30 YEARS		U-20B
		THERMOPLASTIC UNIVERSAL	

© 2023 Carlisle SynTec a division of Carlisle Construction Materials Incorporated

THERMOPLASTIC MEMBRANE

PVC/TPO

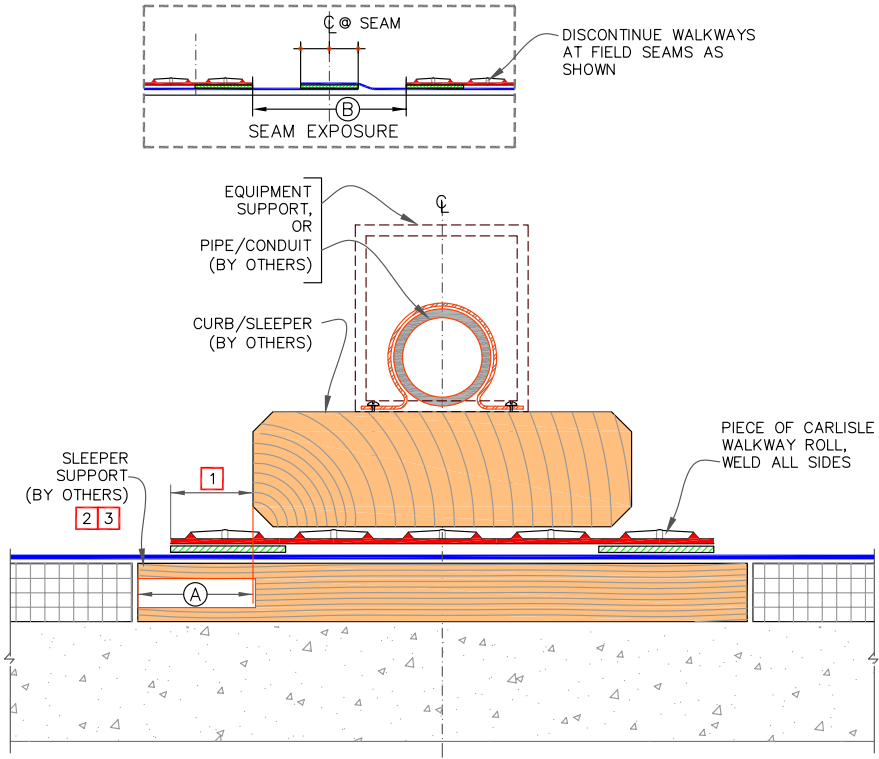

NOTES:

1. SLEEPER MUST BE LARGE ENOUGH TO SUPPORT WEIGHT OF EQUIPMENT WITHOUT INDENTING INSULATION. EXTEND SLEEPER OUT AS REQUIRED BY STRUCTURAL ENGINEER TO DISTRIBUTE SUBJECT LOAD OR AT LEAST EXTEND OUT MIN. 3" (7.5cm).
2. ENSURE SCREW/ANCHOR HEADS IN TOP SURFACE OF WOOD BLOCKING ARE RECESSED TO PROTECT MEMBRANE.
3. SLEEPER SUPPORT NOT REQUIRED UNDER CONDUIT OR PIPE SUPPORTS.
4. CONSULT STRUCTURAL ENGINEER AND/OR SPECIFIER TO AVOID WATER PONDING DUE TO DECK DEFLECTION.
5. RAISE CONDUITS AND PIPES ABOVE THE REGIONAL SNOW LINE WHEN SLOPE OF THE ROOF CAN LEAD TO SLIDING SNOW.

DIMENSIONS	cm		
(A)	3"	7.5	MIN. ALL SIDES
(B)	8"	20	

 WELD

	SLEEPER DETAIL	 DETAIL NO. U-24
	MAXIMUM WARRANTY: 30 YEARS	

Thermoplastic Mechanically Fastened Roofing Systems Induction Welding (RhinoBond / Isoweld) Attachment Method

This is an alternate method for securing the Carlisle’s Sure-Weld (TPO) or Sure-Flex (PVC/KEE HP PVC) membrane and is intended to be used in conjunction with the Carlisle’s Thermoplastic Mechanically Fastened Specification and Details.

A. Description

The Induction Welding (RhinoBond/Isoweld) Attachment Method incorporates 3" diameter corrosion-resistant plates with a hot melt TPO or PVC coating. The RhinoBond or Isoweld Plates are installed with HP-X Fasteners to secure an acceptable insulation to minimum 22 gauge steel deck or minimum 1⁵/₂" thick plywood.

Carlisle’s Polyester Reinforced Thermoplastic membrane is positioned over the secured RhinoBond or Isoweld plates and welded to the top surface of the plate with the RhinoBond or Isoweld Induction Welding Tool.

Induction Welding (RhinoBond/Isoweld) Attachment Method Limited to 20 Year Maximum Warranty and Wind Speed Coverage Up to 90 mph. Perimeter enhancements will be required on systems greater than 72 mph.

Table 1 Induction Welded - Membrane Systems Warranty Options

Years	Thermoplastic Membranes (Sure-Weld TPO/Sure-Flex PVC)		
	Warranty Wind Speed	Minimum Membrane Thickness (1)	Additional Puncture Coverage
	55, 72, 80 or 90 mph		
5,10, or 15 year	√(2)	Sure-Weld 45-mil or Sure-Flex 50-mil	Not Available
20 year	√(2)	Sure-Weld 60-mil or Sure-Flex 60-mil	Not Available

Notes: √= Acceptable

- (1) All "T-Joints" must be overlaid with appropriate flashing material when using 60-mil membrane.
- (2) Perimeter enhancements required for wind speed coverage greater than 72mph. Contact Carlisle for requirements.

Contact Carlisle for requirements for enhancements.

B. Products/Heat Welding Equipment

Products listed in "Part II" of the Carlisle Thermoplastic Mechanically Fastened Roofing System Specification can be used as part of this alternate securement method in conjunction with the RhinoBond or Isoweld Welding Plates.

1. **RhinoBond or Isoweld TPO or PVC Welding Plate:** A 3" diameter, 0.028" thick, corrosion-resistant steel plate with hot melt coating on the top surface. The plate is used in conjunction with Carlisle’s HP-X Fasteners to attach the roofing assembly and is activated using the RhinoBond or Isoweld Induction Welding Tool.
2. **RhinoBond or Isoweld Induction Welding Tool:** An induction heating tool is used to emit the magnetic field that activates the hot melt coating on the top surface of the RhinoBond or Isoweld Welding Plate to fuse with the roofing membrane. Refer to RhinoBond or Isoweld Owner’s Manual for additional information.
3. **Magnet:** A stand-up device that allows the weld to cool as it holds the membrane to the heated plate. Refer to RhinoBond or Isoweld Owner’s Manual for additional information.

C. RhinoBond Induction Tool Calibration

Prior to proceeding with membrane attachment to the plate, the RhinoBond Induction Welding Tool must be calibrated with samples of the project specified insulation thickness and type and project specified membrane thickness. Refer to RhinoBond Owner’s Manual for additional information.

1. Loose lay five RhinoBond Plates in a row about 12" – 24" apart on the specified membrane substrate.
2. Place membrane over the RhinoBond Plates.
3. Centering over the RhinoBond Plate under the membrane, place the Induction Welding Tool and use the device's default setting. Weld the membrane to the first plate, and when ready, completely remove Welding Tool. Immediately place the Magnet on the membrane over the plate and leave in place for 60 seconds.
4. Place Induction Welding Tool on the next plate as previously done and increasing induction energy one level by depressing the "up" button once. After welding, immediately place the Magnet.
5. Repeat above procedure for the remainder of the plates, increasing induction energy one level for each plate.
6. After allowing the membrane and plates to cool to ambient temperature, remove Cooling Clamp and use a pliers by apply force to peel RhinoBond Plate from underside of membrane to determine bonding strength. Desired result is welded ply of membrane stays fused to RhinoBond Plate.
7. Repeat trial process, if needed, adjusting energy level up or down until desired results are achieved.

NOTE: Recalibrate induction tool settings is necessary when ambient temperature changes more than +/- 15°F or power to device has been interrupted.

D. Isoweld Induction Tool Calibration

Calibrate the Isoweld induction welding tool using the process outlined in the Owner's Manual.

E. Installation

1. After placement of insulation on substrate, secure the insulation at a rate of six HP-X Fasteners and RhinoBond or Isoweld Plates per 4' x 8' board in the designated field and eight HP-X Fasteners and RhinoBond or Isoweld Plates around the perimeter. Refer to appropriate Carlisle detail for patterns and depth of perimeter area.
NOTE: Avoiding fastener overdrive to prevent plate from deforming.
2. Place Sure-Weld or Sure-Flex membrane over the appropriate RhinoBond or Isoweld Plates and allow membrane to relax.
3. Place RhinoBond Induction Tool over the RhinoBond TPO or PVC Welding Plate, under the roofing membrane or place the Isoweld Induction Tool over the Isoweld TPO or PVC Welding Plate, until the acoustic search mode signals the inductor is properly positioned.
4. Activate induction welding tool and leave in place until heating cycle is complete.
5. Immediately place Magnet on the membrane over the plate and leave in place for at least 60 seconds.
6. Resume process ensuring membrane is attached to all plates.

F. Membrane Hot Air Welding Procedures & Additional Securement

1. Adjoin membrane sheets by overlapping and heat welding the seam following standard Hot Air Welding Procedures as outlined in the "Part III" of the Thermoplastic Mechanically Fastened Roofing System Specification.
2. Base wall securement and securement around roof penetrations as well as flashings of walls and penetrations must comply with Carlisle requirements for the Thermoplastic Mechanically Fastened Roofing System.

THERMOPLASTIC MEMBRANES Induction Welding

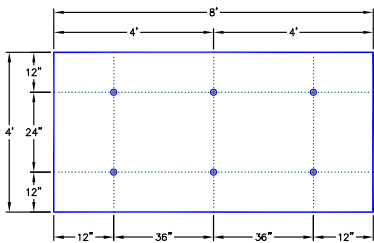

6 FASTENERS PER 4'X8' BOARD

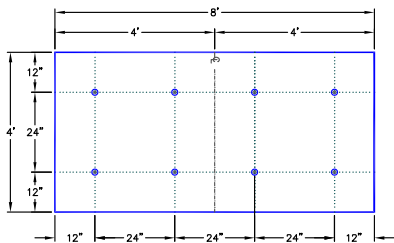

8 FASTENERS PER 4'X8' BOARD

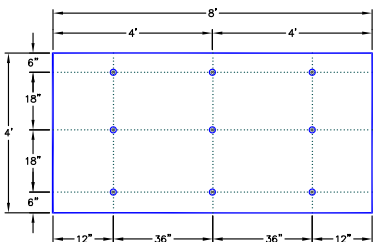

9 FASTENERS PER 4'X8' BOARD

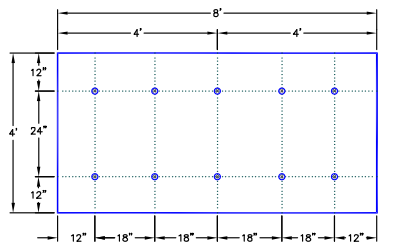

10 FASTENERS PER 4'X8' BOARD

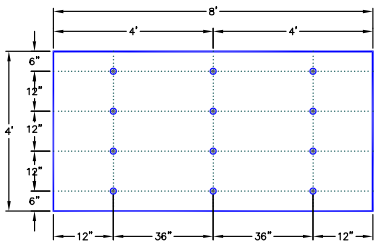

12 FASTENERS PER 4'X8' BOARD

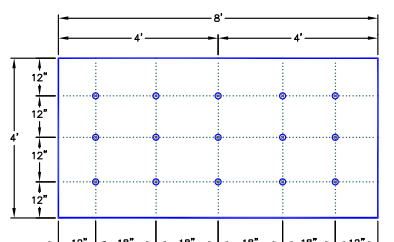

15 FASTENERS PER 4'X8' BOARD

NOTE: FOR FM INSURED PROJECTS, CONSULT FM GLOBAL PRIOR TO INSTALLATION.

<p>— THERMOPLASTIC MEMBRANE — APPROVED SUBSTRATE — SEE NOTE(S)</p>	INDUCTION WELDING ATTACHMENT METHOD – FASTENING PATTERNS/ENHANCEMENTS	DETAIL NO.
		FP-1
For additional information, refer to Specifications		Induction Welding

THERMOPLASTIC MEMBRANES Induction Welding

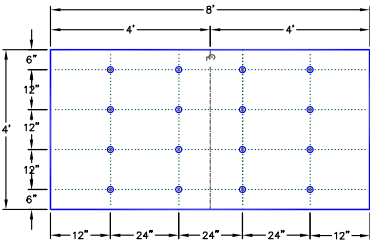

16 FASTENERS PER 4'X8' BOARD

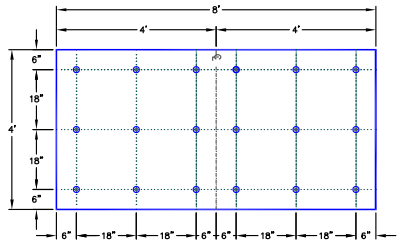

18 FASTENERS PER 4'X8' BOARD

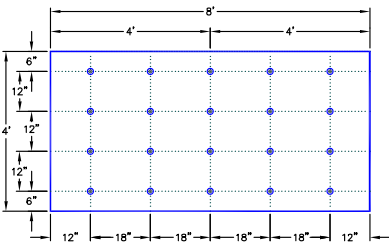

20 FASTENERS PER 4'X8' BOARD

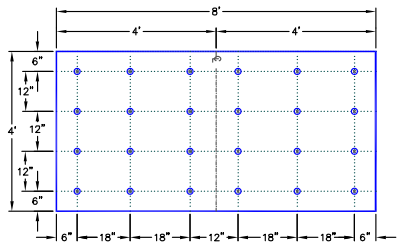

24 FASTENERS PER 4'X8' BOARD

NOTE: FOR FM INSURED PROJECTS, CONSULT FM GLOBAL PRIOR TO INSTALLATION.

<p>— THERMOPLASTIC MEMBRANE — APPROVED SUBSTRATE — SEE NOTE(S)</p>	INDUCTION WELDING ATTACHMENT METHOD – FASTENING PATTERNS/ENHANCEMENTS	DETAIL NO.
		FP-2
For additional information, refer to Specifications		Induction Welding

THERMOPLASTIC MEMBRANES Isoweld Attachment

NOTES:

1. Isoweld METHOD OF MEMBRANE ATTACHMENT IS NOT FOR USE WITH NON-FACED EPS (EXPANDED POLYSTYRENE) OR XPS (EXTRUDED POLYSTYRENE) INSULATIONS.
2. PERIMETER ENHANCEMENTS REQUIRED FOR WIND SPEED COVERAGE GREATER THAN 72MPH. CONTACT CARLISLE FOR REQUIREMENTS.
3. ENHANCEMENTS SHOWN ARE FOR THE PURPOSE OF THE CARLISLE WARRANTY. FOR FM PROJECTS CONSULT FM GLOBAL FOR REQUIRED ENHANCEMENTS.

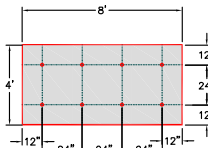

(A) PERIMETER ZONE
8 FASTENERS PER 4'X8' BOARD

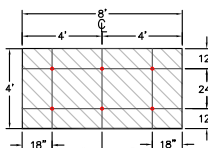

(B) FIELD OF ROOF
6 FASTENERS PER 4'X8' BOARD

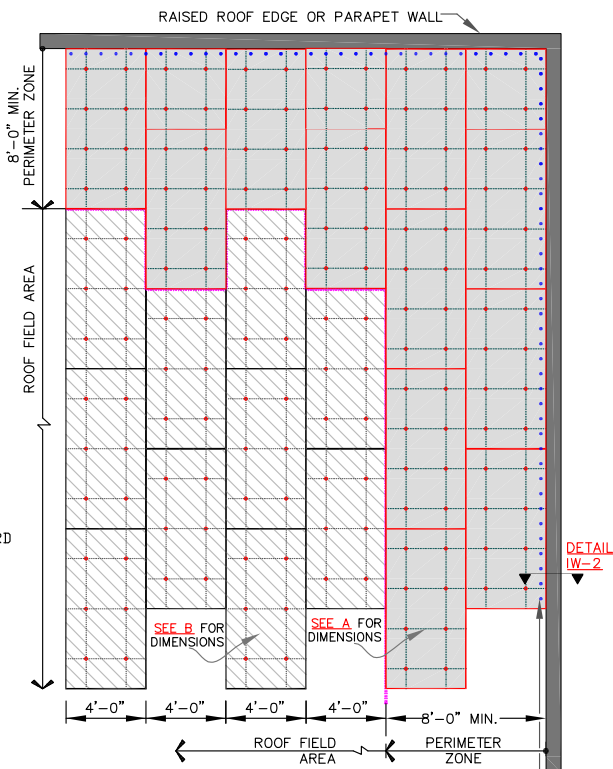
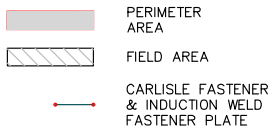

MEMBRANE FASTENED MINIMUM 12" O.C. AT ANGLE(S) CHANGES. FOR ADDITIONAL INFORMATION SEE DETAIL IW-2

DECK TYPE	DECK THICKNESS	FASTENER	THERMOPLASTIC COATED PLATE
STEEL	22 GAUGE(0.8mm)	CARLISLE HP-X FASTENER	3-1/8" (8cm) DIAMETER
PLYWOOD	15/32" (12mm)		

NOTE: AT IN-FILL MINOR PIECES, USE MIN. 2 FASTENERS.

INCHES TO CENTIMETERS						FEET TO CENTIMETERS					
inch	2"	3.5"	4"	12"	18"	24"	30"	FEET	1'	4'	8'
cm	5	9	10	30	46	61	76	cm	30	120	250

THERMOPLASTIC MEMBRANE APPROVED SUBSTRATE SEE NOTE(S)	ISOWELD ATTACHMENT METHOD – NUMBER OF FASTENERS AND LOCATIONS For additional information, refer to Specifications		DETAIL NO. IW-1 Isoweld Attachment
---	--	--	--

© 2023 Carlisle SynTec a division of Carlisle Construction Materials Incorporated

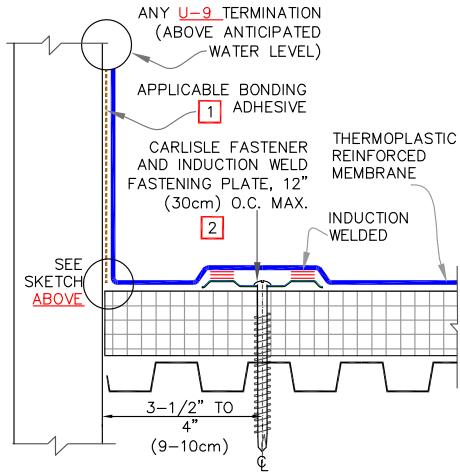
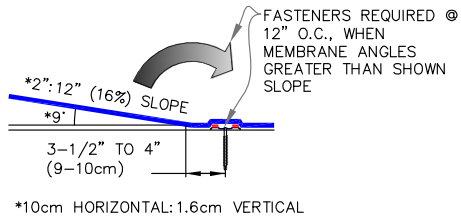
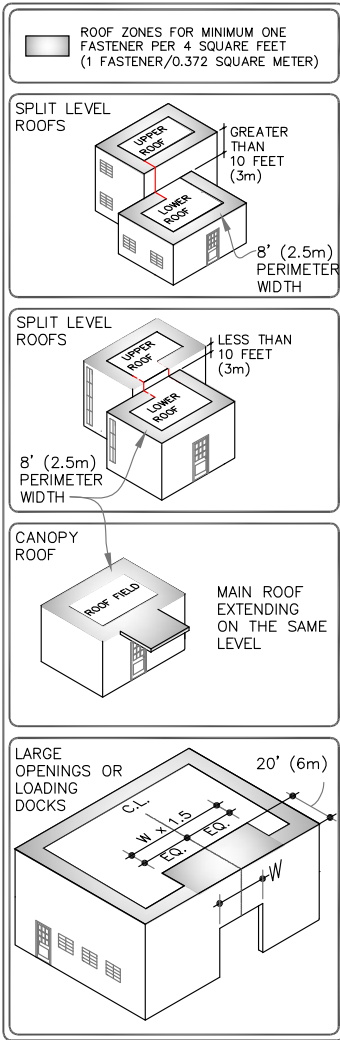

NOTES:

1. SURE-WELD MEMBRANE REQUIRES SURE-WELD BONDING ADHESIVE AND SURE-FLEX MEMBRANE REQUIRES SURE-FLEX BONDING ADHESIVE.
2. HP-X FASTENERS AND INDUCTION WELD PLATES ARE REQUIRED OVER STEEL AND WOOD DECKS. FOR WARRANTY WIND SPEEDS GREATER THAN 72 MPH PLEASE CONTACT CARLISLE FOR REQUIRED FASTENING ENHANCEMENTS.



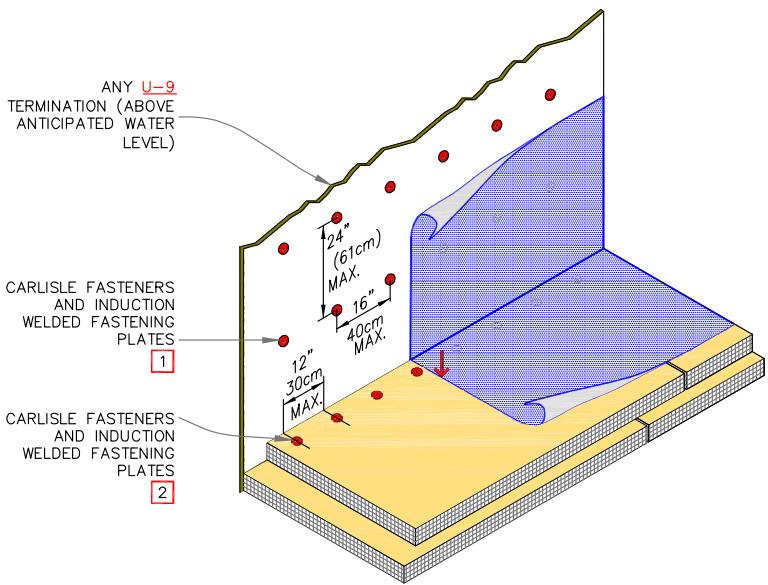

	<p>ANGLE CHANGE SECUREMENT METHOD WITH ISOWELD PLATES</p> <p>For additional information, refer to Specifications</p>		DETAIL NO.
<p>○ → SEE NOTE(S)</p>			IW-2
		Isoweld Attachment	

THERMOPLASTIC MEMBRANES Isoweld Attachment



NOTES:

1. FASTENERS MUST PENETRATE INTO WOOD OR METAL STUDS, WHERE WALL IS BUILT WITH STUDS.
2. HP-X FASTENERS ARE REQUIRED OVER STEEL AND WOOD DECKS.

 → THERMOPLASTIC MEMBRANE	ISOWELD WALL ATTACHMENT		DETAIL NO.
 → APPROVED SUBSTRATE			IW-3
 → SEE NOTE(S)	For additional information, refer to Specifications	Isoweld Attachment	

© 2023 Carlisle SynTec a division of Carlisle Construction Materials Incorporated

THERMOPLASTIC MEMBRANES RhinoBond

NOTES:

1. RhinoBond METHOD OF MEMBRANE ATTACHMENT IS NOT FOR USE WITH NON-FACED EPS (EXPANDED POLYSTYRENE) OR XPS (EXTRUDED POLYSTYRENE) INSULATIONS.
2. PERIMETER ENHANCEMENTS REQUIRED FOR WIND SPEED COVERAGE GREATER THAN 72MPH. CONTACT CARLISLE FOR REQUIREMENTS.
3. ENHANCEMENTS SHOWN ARE FOR THE PURPOSE OF THE CARLISLE WARRANTY. FOR FM PROJECTS CONSULT FM GLOBAL FOR REQUIRED ENHANCEMENTS.

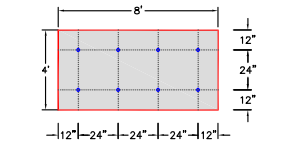

(A) PERIMETER ZONE
8 FASTENERS PER 4'X8' BOARD

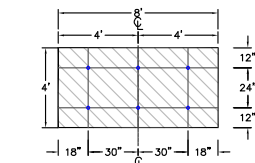

(B) FIELD OF ROOF
6 FASTENERS PER 4'X8' BOARD

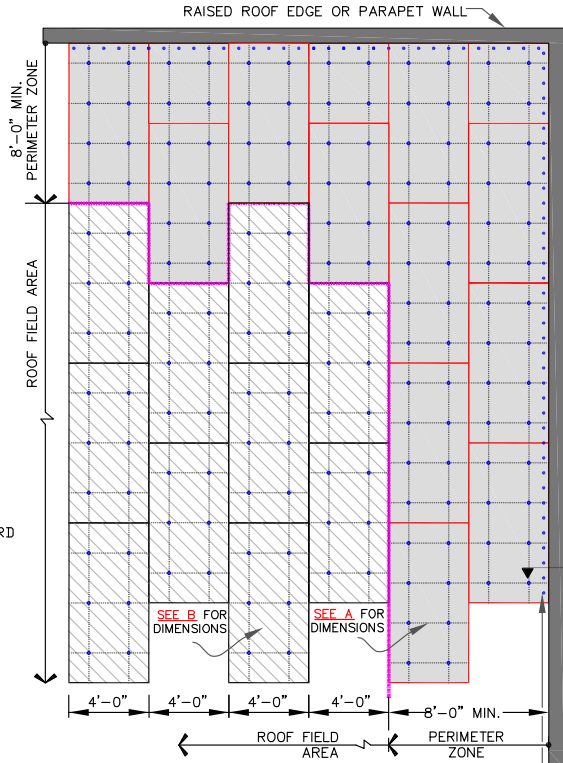
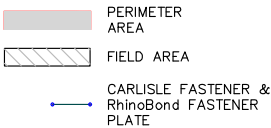

MEMBRANE FASTENED MINIMUM 12" O.C. AT ANGLE(S) CHANGES. FOR ADDITIONAL INFORMATION SEE DETAIL RB-2

DECK TYPE	DECK THICKNESS	FASTENER	THERMOPLASTIC COATED PLATE
STEEL	22 GAUGE(0.8mm)	CARLISLE HP-X FASTENER	3-1/8" (8cm) DIAMETER
PLYWOOD	15/32" (12mm)		

NOTE: AT IN-FILL MINOR PIECES, USE MIN. 2 FASTENERS.

INCHES TO CENTIMETERS							FEET TO CENTIMETERS				
inch	2"	3.5"	4"	12"	18"	24"	30"	FEET	1'	4'	8'
cm	5	9	10	30	46	61	76	cm	30	120	250

-- THERMOPLASTIC MEMBRANE -- APPROVED SUBSTRATE -- SEE NOTE(S)	RhinoBond ATTACHMENT METHOD – NUMBER OF FASTENERS AND LOCATIONS For additional information, refer to Specifications		DETAIL NO. RB-1 RhinoBond
--	--	--	--

THERMOPLASTIC MEMBRANES

RhinoBond

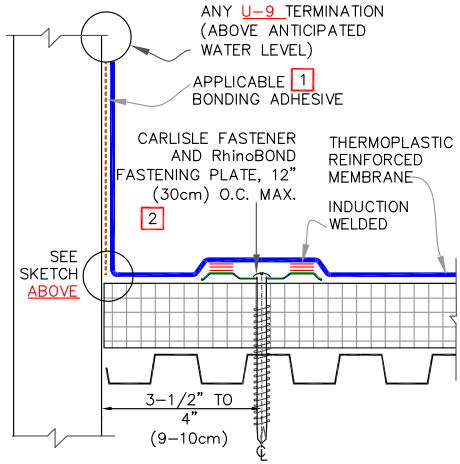
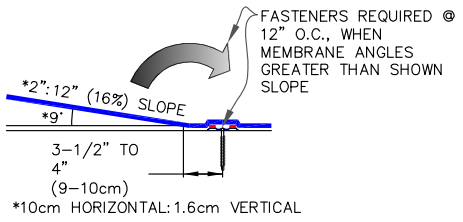
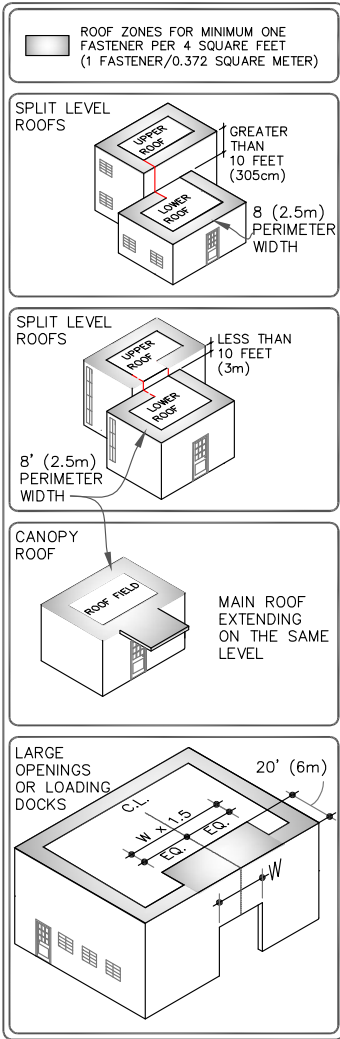

ANGLE CHANGE SECUREMENT

NOTES:



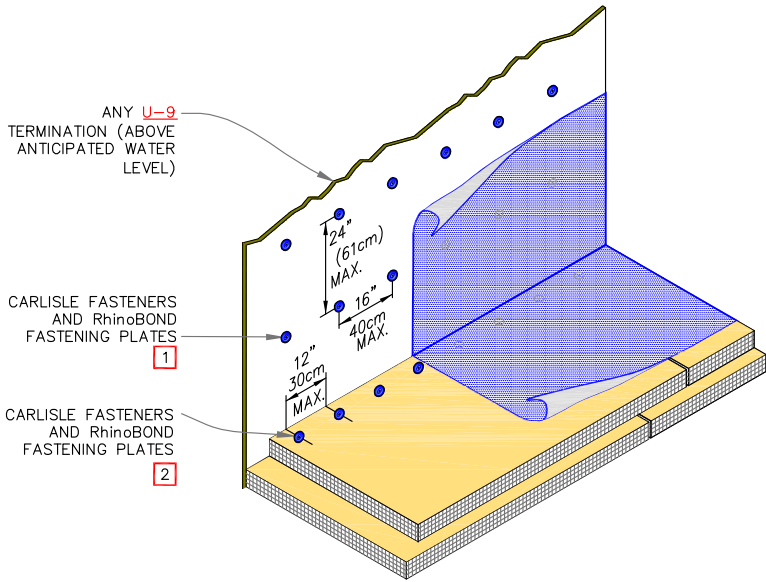

1. SURE-WELD MEMBRANE REQUIRES SURE-WELD BONDING ADHESIVE AND SURE-FLEX MEMBRANE REQUIRES SURE-FLEX BONDING ADHESIVE.
2. HP-X FASTENERS AND RhinoBOND PLATES ARE REQUIRED OVER STEEL AND WOOD DECKS. FOR WARRANTY WIND SPEEDS GREATER THAN 72 MPH PLEASE CONTACT CARLISLE FOR REQUIRED FASTENING ENHANCEMENTS.

<p>— THERMOPLASTIC MEMBRANE</p> <p>— APPROVED SUBSTRATE</p> <p>0 — SEE NOTE(S)</p>	<p>ANGLE CHANGE SECUREMENT METHOD WITH RhinoBond PLATES</p> <p>For additional information, refer to Specifications</p>	<p>DETAIL NO. RB-2</p> <p>RhinoBond</p>
--	--	---



NOTES:

1. FASTENERS MUST PENETRATE INTO WOOD OR METAL STUDS, WHERE WALL IS BUILT WITH STUDS.
2. HP-X FASTENERS AND RhinoBOND PLATES ARE REQUIRED OVER STEEL AND WOOD DECKS.

 -- THERMOPLASTIC MEMBRANE	RhinoBond WALL ATTACHMENT		DETAIL NO.
 -- APPROVED SUBSTRATE			RB-3
 -- SEE NOTE(S)	For additional information, refer to Specifications		RhinoBond

LIQUISEAL Liquid Flashing

The information contained in this supplement serves as a criteria for Specifiers and Authorized Applicators regarding the design and installation of Carlisle Roofing Systems and use of liquid flashing to complete tie-in details and flash unusual and round penetrations. In addition to the information contained herein, attachment details 1 through 3 are included to provide the Specifiers and Authorized Applicators with quick access to specific information. Specifiers and Authorized Applicators are advised to reference all applicable details included with this spec supplement.

A. General

LIQUISEAL Liquid Flashing is a two-component, polyurethane-based system which creates a reinforced, cold-applied liquid flashing that is compatible with all Carlisle TPO, PVC, and KEE HP membranes. LIQUISEAL Liquid Flashing is designed for use with oddly shaped penetrations and tying together dissimilar roofing systems without building an isolation curb or impeding drainage. LIQUISEAL Liquid Flashing is UV- and color-stable, solvent-free, low-VOC, and virtually odorless.

LIQUISEAL Liquid Flashing consists of the following products:

1. LIQUISEAL Resin – Two-component polyurethane-based resin, when mixed will be white in color. Available in 0.56 gallon (2.1 l) sachets and 1.03 gallon (3.9 l) pails. Coverage rate of 13.6 square feet (1.26 meters square) per gallon (3.8 l).
2. LIQUISEAL Fleece – 50-mil thick, white, Non-woven, needle-punched polyester fabric reinforcement. Available in rolls of 13.8" (350 mm) and 27" (685 mm) widths by 164'-0" (50 m) length.
3. LIQUISEAL Metal Primer – A solvent-free, high solids, two-part, cold-applied polyurethane resin. Used to prime metal, and other non-porous surfaces. Available in 0.25 gallon (0.9 l) sachets. Coverage rate of 25 square feet (2.3 square meters) per 0.25 gallon (0.9 l) sachet.
4. LIQUISEAL Concrete & Masonry Primer – A solvent-free, two-part, cold-applied liquid epoxy resin. Used with Surfacing Sand to prime concrete, masonry, and other porous surfaces. Available in 0.25 gallon (0.9 l) sachets and 1.1 gallon (4.2 l) pails. Coverage rate of 19 square feet (1.76 square meters) per 0.25 gallon (0.9 l) sachet.
5. LIQUISEAL Spiral Mixing Agitator – A 3" (7.62 cm) long steel spiral agitator with a ½" (1.27 cm) hex drive for use with handheld drills and mixers. Used to properly mix resin.
6. LIQUISEAL Surfacing Sand – Kiln-dried #00 - #35 graded sand suitable for broadcasting into LIQUISEAL Liquid Flashing Concrete & Masonry Primers for use in substrate preparation. Used with Concrete & Masonry Primer to promote proper adhesion and mechanical bond. Packaged in 50lb (22.6 kg) bags.

B. Warranty

Projects meeting the conditions below can be eligible for a maximum 20 year System Warranty with wind speed coverage up to 90 mph peak gusts. Projects requiring extended wind speed coverage warranty must be submitted to Carlisle for review prior to installation.

C. Precautions

1. Always store in a cool, dry location between 35°F – 80°F (1.7°C – 27°C). Do not store in direct sunlight. Approximate shelf life is 12 months with proper storage. Best practice is to store material at 65°F – 70°F (18°C – 21°C) for 24 hours before use.
2. Do not install if ambient temperature is below 40°F (4°C) or above 90°F (32°C).
3. Do not break down work packs into smaller quantities; mix the entire work pack.
4. Prepare surfaces and pre-cut all fleece before mixing resin. Pot life will be shorter as ambient temperature rises.
5. Use appropriate safety glasses and protect hands and wrists by wearing gloves.

D. Installation

1. **Surface Preparation:** Prepare all substrates by removing any irregularities and any loose or foreign material such as dirt, water, grease, oil, lacquers, or release agents. Prepare membrane by sanding with 60-grit sandpaper.
2. **Metal Primer Application:**
 - a. All metal surfaces must be prepared using a grinder. Do not use a wire brush. Ensure that all metal surfaces are ground down to expose bare metal.
 - b. Remove bag from the aluminum packaging. Knead cream-colored resin (Component A) thoroughly until a uniform color is achieved.
 - c. Pull away the rubber cord separating the two components so that Components A and B can be mixed together. Knead the bag quickly and thoroughly for approximately 1 minute so that a homogenous primer is formed. The primer should be a uniform color, with no light or dark streaks present.
 - d. After the primer is mixed, cut off one corner of the bag and pour all primer into a clean, new mixing pail. Working quickly, apply approximately 25 square feet (2.3 square meters) per 0.25 gallon (0.9 l) sachet. The primer should be rolled or brushed evenly onto the surface in a cross-directional method to fully cover the substrate in one application. Allow to set for approximately 3 hours or until fully cured prior to application of the LIQUISEAL Liquid Flashing Resin.

NOTE: LIQUISEAL Liquid Flashing Resin must be applied when the primer is completely dry and without tack. Do not apply LIQUISEAL Liquid Flashing Resin to tacky or wet primer.

3. **Concrete & Masonry Primer Application:**
 - a. Prepare all substrates by removing any irregularities and any loose or foreign materials such as dirt, water, grease, oil, lacquers, or release agents using a grinder. All concrete substrates should be dry and fully cured.
 - b. Remove bag from the aluminum packaging. Knead translucent yellow resin (Component A) thoroughly until a uniform color is achieved.
 - c. Pull away the rubber cord separating the two components so that Components A and B can be mixed together. Knead the bag quickly and thoroughly for approximately 1 minute so that a homogenous primer is formed. The primer should be a uniform color, with no light or dark streaks present.
 - d. After the primer is mixed, cut off one corner of the bag and pour all primer into a clean, new mixing pail. Working quickly, apply at a rate of approximately 19 square feet (1.76 square meters) per 0.25 gallon (0.9 l) sachet. The primer should be rolled or brushed evenly onto the surface in a cross directional method to fully cover the substrate in one application.
 - e. After applying the primer, immediately broadcast LIQUISEAL Liquid Flashing Concrete & Masonry Preparation Sand into the uncured primer at the approximate rate of 50 lbs (22.6 kg) per 100 square feet (9.29 square meters). Allow to set for approximately 4 hours or until fully cured prior to application of the LIQUISEAL Liquid Flashing Resin.
 - f. In warm climates, higher contents of moisture or vapor within a concrete substrate may cause pin-holing of the primer due to vapor drive. Applying primer later in the day when temperatures are lower can improve this condition.

NOTE: LIQUISEAL Liquid Flashing Resin must be applied when the primer is completely dry and without tack. Do not apply LIQUISEAL Liquid Flashing Resin to tacky or wet primer.

4. LIQUISEAL Liquid Flashing Application:
 - a. Apply the appropriate primer to membrane and allow to flash off. Apply appropriate primer to all other surfaces to which flashing will be applied.
 - b. Cut and prepare all reinforcing fleece before mixing resin.
 01. For LIQUISEAL Resin in 1.03 gallon (3.9 l) Pail Packaging
 - i. Mix resin (Component A) with a clean spiral agitator until the liquid is a uniform white color.
 - ii. Add hardener (Component B) to Component A and mix with a spiral agitator for 2 minutes or until both liquids are thoroughly blended.
 02. For LIQUISEAL in 0.25 gallon (0.9 l) Sachet Packaging
 - i. Remove bag from the aluminum packaging.
 - ii. Knead white resin (Component A) thoroughly until a uniform color is achieved.
 - iii. Pull away the rubber cord separating the two components so that Components A and B can be mixed together. Knead the bag quickly and thoroughly for approximately 1 minute so that a homogenous resin is formed. The resin should be a uniform color, with no light or dark streaks present.
 - iv. After the resin is mixed, cut off one corner of the bag and pour entire sachet of resin into a clean, new mixing pail. Working quickly, apply at a rate of approximately 13.6 square feet (1.3 square meter) per gallon (3.8 l).
 - c. Using a nap roller or brush, apply two-thirds of the resin evenly onto the substrate using even strokes.
 - d. Roll the LIQUISEAL Liquid Flashing Fleece directly into the LIQUISEAL Liquid Flashing Resin, ensuring that the SMOOTH SIDE IS FACING UP (natural unrolling procedure) and avoiding folds, wrinkles, and air pockets.
 - e. Apply the remaining one-third of the resin and use the roller or brush to work the resin into the fleece, saturating from the bottom up. All areas of the fleece should be completely saturated with resin.
 - f. Repeat steps 'b through e' again for subsequent layers of resin and flashing as needed for detailing.



Scan here to view Liquid Flashing Installation Videos.

LIQUID FLASHING EPDM/TPO/PVC

Notes:

- The following tables provide recommendations for preparation and priming of substrates and should be used as a guideline for proper adhesion & performance.
- The primer application rate will vary and should be adjusted depending on the substrate. See Product Data Sheets, SDS, Guide Specifications and Details for complete information regarding the suitability, application and handling of products.

INSPECTION		EPDM	TPO	PVC / KEE / HP	METAL SURFACES	MASONRY
A.1	Inspect insulation for wet conditions underneath the roof membrane. Remove & replace wet materials underneath to match in kind.	Y	Y	Y		
A.2	Ensure, membrane or roof assembly is properly secured.	Y	Y	Y		
A.3	Provide additional securement at the base of penetrations, tie-ins or angle changes per details.	Y	Y	Y		
A.4	Ensure, there is no standing water. Remove and dry the work area. Remove dust, debris and wipe the work surfaces clean. Masonry must be completely dry and sound.	Y	Y	Y	Y	Y
A.5	Verify structural integrity of metal objects. Check for broken welds or loose bolts. Verify the thickness of exposed metal after removal of finishes or rust for strength.				Y	
A.6	Ensure, there is no moisture present in the substrate.	Y	Y	Y	Y	Y
A.7	Within the work area, inspect the seams of existing membrane for proper seal.	Y	Y	Y		
A.8	Do not damage structural members, welds or remove any nuts/bolts unless approved by designer.				Y	
CLEANING & SUBSTRATE PREPARATION		EPDM	TPO	PVC / KEE / HP	METAL SURFACES	MASONRY
B.1	Use 60 grit sandpaper to rough up the top surface of the membrane.	Y	Y	Y		
B.2	Use abrasive grinding wheel (a diamond cup wheel is suggested) to expose the bare metal (do not use wire brush). Expose metal around nuts & tighten as needed. Wipe the membrane cleaner.				Y	Y
B.3	Remove dust, clean the surfaces with broom & power blower.	Y	Y	Y	Y	Y
B.4	Wipe the surfaces with Carlisle Membrane Cleaner , (Standard or Low VOC)	Y	Y	Y	Y	
B.5	Use painter's tape to contain flashing resin. Tape shall be set 1/4" to 1/2" (1-1.5cm) beyond the fleece edges.	Y	Y	Y	Y	Y
EXISTING BITUMINOUS ROOFING SUBSTRATES					CONCRETE & MASONRY PRIMER	
C.1	Modified Bitumen Smooth APP Surfaced.	Power wash to remove contaminants.			Y	
C.2	Modified Bitumen Smooth SBS Surfaced.					
C.3	Bituminous Roofing – Granular Surfaced.	Power wash to remove contaminants & loose granules				
C.4	Following bituminous substrates are not acceptable: Aluminum coating, flood coat & aggregate, cool tar pitch roofing – flood coat & aggregate, hot-melt bituminous waterproofing & ethylene-faced bituminous (bituthane) roofing.					

INSPECTION CLEANING & SUBSTRATE PREPARATION (PAGE 1 OF 2)		ATTACHMENT 1
For additional information, refer to Spec. Supplement	LIQUID FLASHING	

METAL SUBSTRATES			METAL PRIMER
D.1	Bare aluminum, lead, copper & zinc.	Grind to remove corrosion, then use membrane cleaner to wipe and clean.	Ⓚ
D.2	Bare steel, galvanized steel.		
D.3	Black pipe, cast iron.	Grind to remove corrosion and coating. Then use membrane cleaner to wipe and clean.	Ⓚ
D.4	Stainless steel.	Grind to achieve rough surface. Then use membrane cleaner to wipe and clean.	Ⓚ
D.5	Kynar finish, ceramic coated, and painted metal.	Grind to remove coating. Then use membrane cleaner to wipe and clean.	Ⓚ
CEMENTITIOUS AND MASONRY SUBSTRATES			MASONRY PRIMER
E.1	Structural & or lightweight structural concrete.	Scarify, shot blast or grind to remove laitance and open up pores	Ⓚ
E.2	Granite, Marble.	Scarify, shot blast, grind to remove polished surface and open up pores	Ⓚ
E.3	Clay brick, terra cotta, tile.	Scarify, shot blast, grind to remove glazed surface and open up pores.	Ⓚ
E.4	Sandstone, limestone, synthetic stone.	Scarify, shot blast, grind to open up pores	Ⓚ
E.5	Porous/air-entrained concrete, concrete masonry block.		
E.6	Repair & leveling mortars.		
GLASS & PLASTIC SUBSTRATES			METAL PRIMER
F.1	Glass.	Sand to abrade surface. Then use membrane cleaner to wipe and clean.	Ⓚ
F.2	Acrylic.		
F.3	Fiberglass.		
F.4	ABS, PVC – Rigid.		

Note: Contact Carlisle SynTec for substrate not listed in these tables.

CAUTION:

All substrates must be prepared as necessary prior to the application of primers. Surfaces must be free from irregularities, loose, unsound or foreign materials such as rust, dirt, ice, snow, water, grease, oil, release agents, paint, lacquers, coatings, or any other conditions that would be detrimental to adhesion of the primer and resin.

INSPECTION CLEANING & SUBSTRATE PREPARATION (PAGE 2 OF 2)		ATTACHMENT 1
		LIQUID FLASHING
For additional information, refer to Spec. Supplement		

LIQUISEAL PRIMER & RESIN APPLICATION		EPDM	TPO	PVC / KEE HP	METAL SURFACES	MASONRY
G.1	Ensure all surfaces are ready for application of primer prior to mixing, due to limited pot life.	Y	Y		Y	Y
G.2	Mix primer thoroughly, per specifications.	Y	Y		Y	Y
G.3	Apply LIQUISEAL Metal Primer per specifications.	Y			Y	
G.4	Masonry: Apply LIQUISEAL Concrete & Masonry Primer and surfacing sand per specifications.					Y
G.5	Wait for primer to cure per written instructions.	Y			Y	Y
G.6	Apply Low VOC Primer and allow to flash off completely.		Y			
G.7	Cut & dry-fit all fleece prior to mixing resin. Ensure, the fleece is set back from painter's tape, per B.5 .	Y	Y	Y	Y	Y
G.8	Mix LIQUISEAL Flashing Resin thoroughly (with spiral agitator if in pail).	Y	Y	Y	Y	Y
G.9	Apply a base layer of LIQUISEAL Flashing Resin ensuring generous coverage of entire substrate.	Y	Y	Y	Y	Y
G.10	Immediately press LIQUISEAL Flashing Fleece into the applied LIQUISEAL Flashing Resin , taking care at corners and crevices.	Y	Y	Y	Y	Y
G.11	Apply a 2nd (top coat) of LIQUISEAL Flashing Resin ensuring the fleece is completely saturated per published coverage rate.	Y	Y	Y	Y	Y

APPLICATION OF LIQUISEAL PRIMER & RESIN		ATTACHMENT 2
For additional information, refer to Spec. Supplement	LIQUID FLASHING	

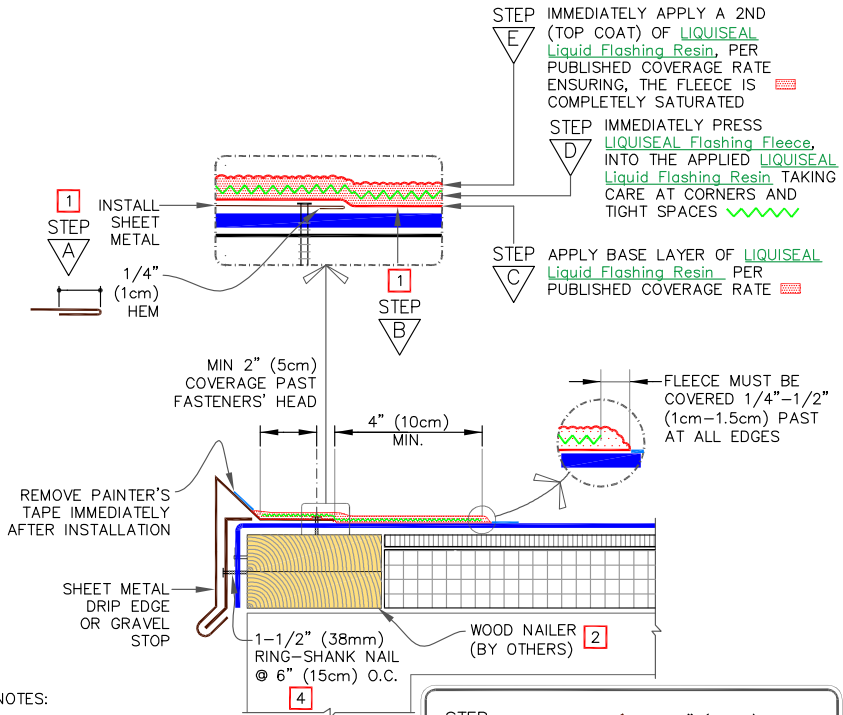

NOTES:

- REFER TO TABLES ON SHEETS ATTACHMENT 1-2 FOR DETAILED INSPECTION, CLEANING AND PRIMING FOR DIFFERENT MATERIALS WITHIN THE FLASHING AREAS.
- WOOD NAILER MUST EXTEND PAST TOTAL WIDTH OF SHEET METAL FLANGE.
- SAME DETAIL APPLIES AT THE TOP OF PARAPET WALL, WHERE FULL COPING IS NOT USED.
- FASTENERS MUST BE SECURED INTO STRUCTURAL MEMBERS, E.G., CONCRETE, SOLID MASONRY OR WOOD BLOCKING.
- DETAIL NOT FOR USE ON WARRANTY PROJECTS EXCEEDING 20-YEARS. UNLESS OTHERWISE SPECIFIED.

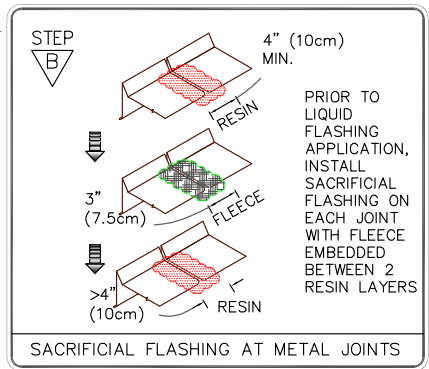

	<p>SHEET METAL DRIP EDGE OR GRAVEL STOP FLASHING</p> <p>For additional information, refer to Specifications</p>	<p>DETAIL NO. LF-1.1</p> <p>LIQUID FLASHING</p>
--	---	---

LIQUID FLASHING

EPDM/TPO/PVC

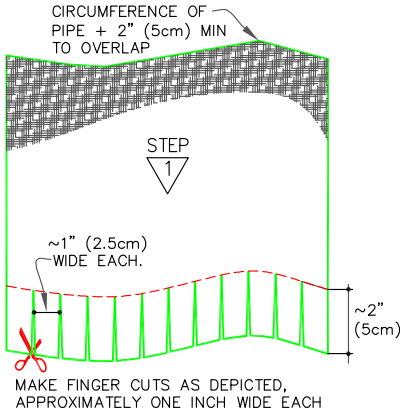

APPLY BASE COAT OF LIQUISEAL Liquid Flashing Resin PER PUBLISHED COVERAGE RATE

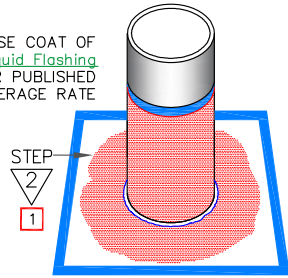

APPLY BASE COAT OF LIQUISEAL Liquid Flashing Resin ON HORIZONTAL SURFACES. IMMEDIATELY PRESS FLEECE INTO RESIN AND OVERLAP LIQUISEAL Flashing Fleece, MIN. 2" (5cm)

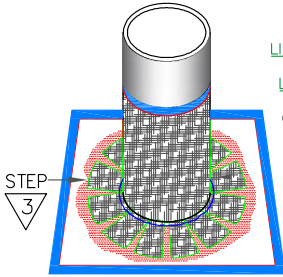

IMMEDIATELY PRESS LIQUISEAL Flashing Fleece INTO THE APPLIED LIQUISEAL Liquid Flashing Resin. APPLY SECOND COAT OF RESIN. ENSURE ALL ENDS OF FINGERS ARE PROPERLY EMBEDDED.

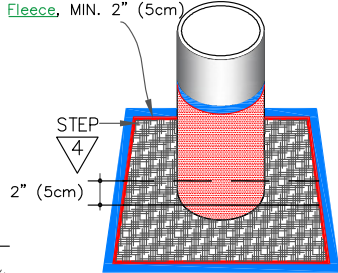

FLEECE MUST BE COVERED 1/4" - 1/2" (1cm - 1.5cm) PAST ALL EDGES

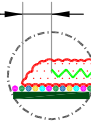

NOTES:

1. FOR MULTIPLE PIPE PENETRATIONS SEE STEP ZERO ON SHEET LF-8.1 (PAGE 2 OF 2) AND FOLLOW REST OF THE STEPS AS SHOWN FOR SINGLE PIPE FLASHING.
2. REFER TO TABLES ON SHEETS ATTACHMENT 1-2 FOR DETAILED INSPECTION, CLEANING AND PRIMING FOR DIFFERENT MATERIALS WITHIN THE FLASHING AREAS.
3. SEE PAGE 2 OF 2 FOR ADDITIONAL NOTES.

APPLY A TOP COAT OF LIQUISEAL Liquid Flashing Resin, ENSURING THE FLEECE IS COMPLETELY SATURATED PER PUBLISHED COVERAGE RATE AND APPLY 1/4"-1/2" (1cm-1.5cm) BEYOND THE FLEECE EDGES

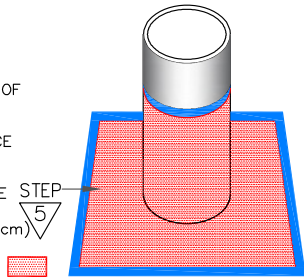

	<p>SINGLE OR MULTIPLE PIPE PENETRATIONS (PAGE 1 OF 2)</p> <p>For additional information, refer to Specifications</p>	<p>DETAIL NO.</p> <p>LF-8.1</p> <p>LIQUID FLASHING</p>
--	--	--

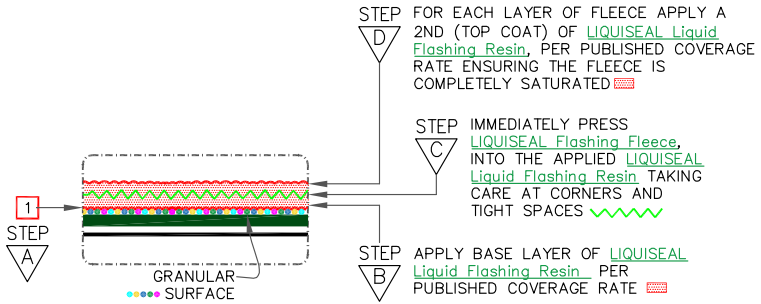

SEAM FASTENING PLATES & FASTENERS

DIMENSIONS	cm	
(A)	6"	15 TO
	12"	30
(B)	12"	30 MAX.

4 FASTENERS REQUIRED MIN.

PLAN VIEW

PIPE OUTSIDE DIAMETER < 6" (15cm)

PIPE OUTSIDE DIAMETER > 6" (15cm)

TABLE FOR FASTENER REQUIREMENTS ON MECHANICALLY FASTENED SYSTEMS. REFER TO CARLISLE TYPICAL PENETRATION DETAILS FOR FLASHING OVER FASTENER HEADS.

NOTES CONTINUE FROM [LF-8.1 \(PAGE 1 OF 2\)](#)

- WHEN THERE IS ENOUGH CLEARANCE BETWEEN MULTIPLE PENETRATIONS, INSTALL LIQUID FLASHING USING THIS DETAIL.
- WHEN INSTALLATION OF LIQUID FLASHING IS NOT FEASIBLE FOR MULTIPLE PIPE PENETRATIONS, THEN USE APPLICABLE STANDARD ROOF MEMBRANE DETAIL (U-16) FOR FIELD MEMBRANE TYPE.
- DETAIL NOT FOR USE ON WARRANTY PROJECTS EXCEEDING 20-YEARS. UNLESS OTHERWISE SPECIFIED.

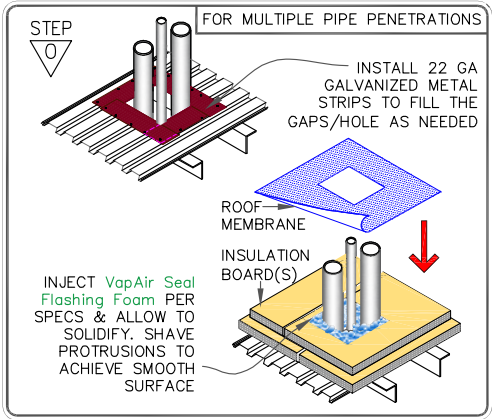

	<p>SINGLE OR MULTIPLE PIPE PENETRATIONS (PAGE 2 OF 2)</p> <p>For additional information, refer to Specifications</p>	<p>DETAIL NO.</p> <p>LF-8.1</p> <p>LIQUID FLASHING</p>
--	--	--

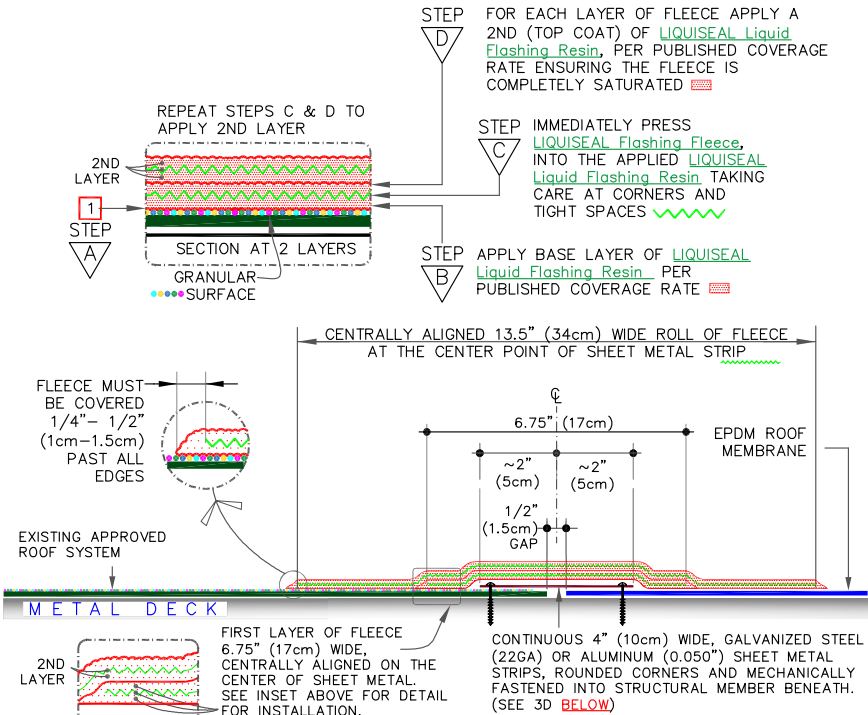

NOTES:

1. REFER TO [TABLES ON SHEETS ATTACHMENT 1-2](#) FOR DETAILED INSPECTION, CLEANING AND PRIMING FOR DIFFERENT MATERIALS WITHIN THE FLASHING AREAS.
2. IF FLUTES ARE PERPENDICULAR DRILL A 3/8"(1cm) WEEP HOLE IN THE BOTTOM FLUTES OF THE STEEL DECK ALONG THE TIE IN.
3. DETAIL NOT FOR USE ON WARRANTY PROJECTS EXCEEDING 20-YEARS, UNLESS OTHERWISE SPECIFIED.

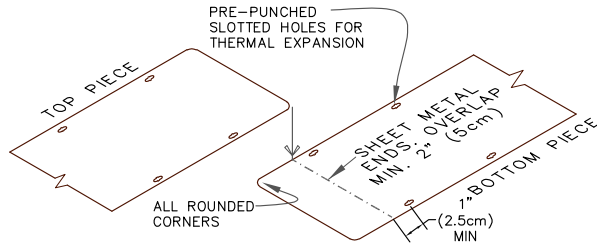

	<p>EPDM MEMBRANE TIE-IN WITH EXISTING ROOF OVER STEEL DECK</p> <p>For additional information, refer to Specifications</p>	<p>DETAIL NO.</p> <p>LF-13.1</p> <p>LIQUID FLASHING</p>
--	---	---

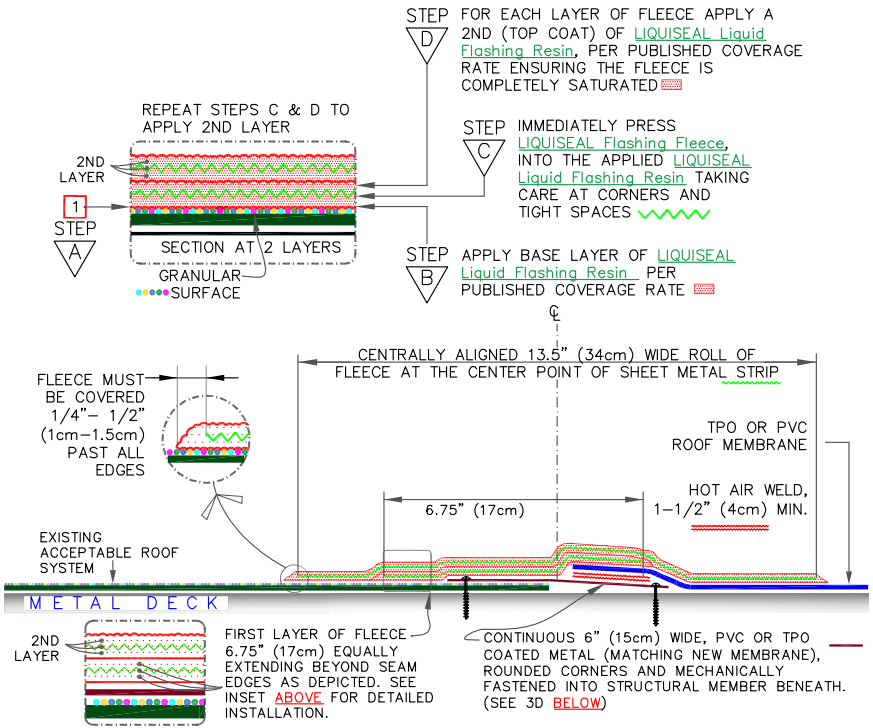

NOTES:

- REFER TO TABLES ON SHEETS ATTACHMENT 1-2 FOR DETAILED INSPECTION, CLEANING AND PRIMING FOR DIFFERENT MATERIALS WITHIN THE FLASHING AREAS.
- IF FLUTES ARE PERPENDICULAR DRILL A 3/8" (1cm) WEEP HOLE IN THE BOTTOM FLUTES OF THE STEEL DECK ALONG THE TIE IN.
- DETAIL NOT FOR USE ON WARRANTY PROJECTS EXCEEDING 20-YEARS, UNLESS OTHERWISE SPECIFIED.

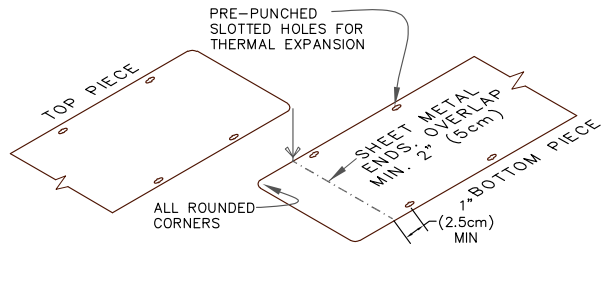

<p>— ROOF MEMBRANE</p> <p>— LIQUISEAL Flashing Fleece</p> <p>— LIQUISEAL Liquid Flashing Resin</p> <p>0 — SEE NOTE(S)</p>	<p>TPO OR PVC MEMBRANE TIE-IN WITH EXISTING ROOF OVER STEEL DECK (PAGE 1 OF 2)</p> <p>For additional information, refer to Specifications</p>	<p>DETAIL NO.</p> <p>LF-13.2</p> <p>LIQUID FLASHING</p>
---	---	---

LIQUID FLASHING

TPO/PVC



INSTALL COATED SHEET METAL STRIPS WITH THREADED FASTENERS. REFER TO TABLES ON SHEETS [ATTACHMENT 1-2](#) FOR DETAILED INSPECTION, CLEANING AND PRIMING FOR DIFFERENT MATERIALS WITHIN THE FLASHING AREAS.



PROPERLY CLEAN WITH MEMBRANE CLEANER PRIOR TO WELDING.

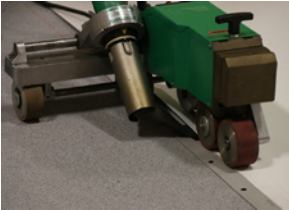

WELD TPO OR PVC MEMBRANE TO COATED METAL STRIP.



USE SAND PAPER CRIT # 60 TO ABRASE THE AREAS TO WHICH THE LIQUISEAL LIQUID FLASHING RESIN WILL BE APPLIED.



THOROUGHLY CLEAN THE TIE-IN AREA.



CUT TWO PIECES OF [LIQUISEAL Flashing Fleece](#), (FOR DIMENSIONS SEE [LF-13.2A](#)).



APPLY PAINTER'S TAPE ALONG TIE-IN EDGE.



THOROUGHLY MIX THE RESIN, PER PUBLISHED INSTRUCTIONS.



INSTALL BOTH LAYERS OF PRE-CUT [LIQUISEAL Flashing Fleece](#), EMBEDDED IN RESIN (SEE [LF-13.2A](#)).

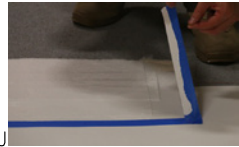

REMOVE TAPE IMMEDIATELY ENSURING THAT RESIN EXTENDS 1/4" - 1/2" BEYOND EDGE OF FLEECE.

<ul style="list-style-type: none"> ROOF MEMBRANE LIQUISEAL Flashing Fleece LIQUISEAL Liquid Flashing Resin SEE NOTE(S) 	TPO OR PVC MEMBRANE TIE-IN WITH EXISTING ROOF OVER STEEL DECK (PAGE 2 OF 2) For additional information, refer to Specifications		DETAIL NO. LF-13.2 LIQUID FLASHING
--	--	--	---

LIQUID FLASHING

EPDM/TPO/PVC

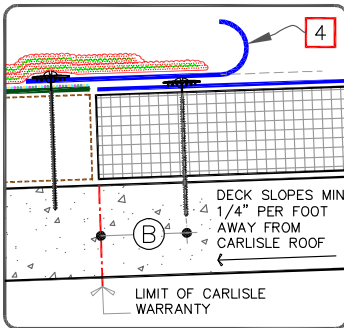
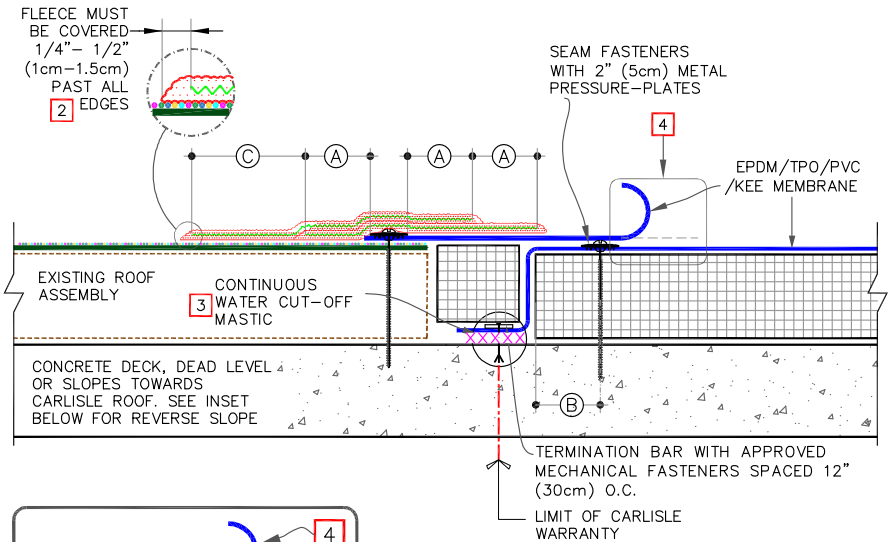

NOTES:

1. REFER TO TABLES ON [SHEETS ATTACHMENT 1-2](#) FOR DETAILED INSPECTION, CLEANING AND PRIMING FOR DIFFERENT MATERIALS WITHIN THE FLASHING AREAS.
2. DETAIL NOT FOR USE ON WARRANTY PROJECTS EXCEEDING 20-YEARS. UNLESS OTHERWISE SPECIFIED.
3. PROPERLY FILL THE JOINTS, VOIDS AND CRACKS ENSURING PROPER SEAL AGAINST WATER MIGRATION.
4. APPLICABLE SEAM DETAILS:
 - 4.1. EPDM: [U-2A](#) & [U-2A.1](#)
 - 4.2. TPO/PVC/KEE: [U-2A](#)

DIMENSIONS		cm	
(A)	3"	7.5	MIN.
(B)	2-3"	5-7.5	MIN.
(C)	AS REQUIRED DEPENDING ON SUBSTRATE, BUT MIN. 4" (10cm).		

	→ ROOF MEMBRANE
	→ LIQUISEAL Flashing Fleece
	→ LIQUISEAL Liquid Flashing Resin
	→ SEE NOTE(S)

MEMBRANE TIE-IN WITH EXISTING ROOF OVER CONCRETE DECK
For additional information, refer to Specifications

	DETAIL NO. LF-13.3
LIQUID FLASHING	

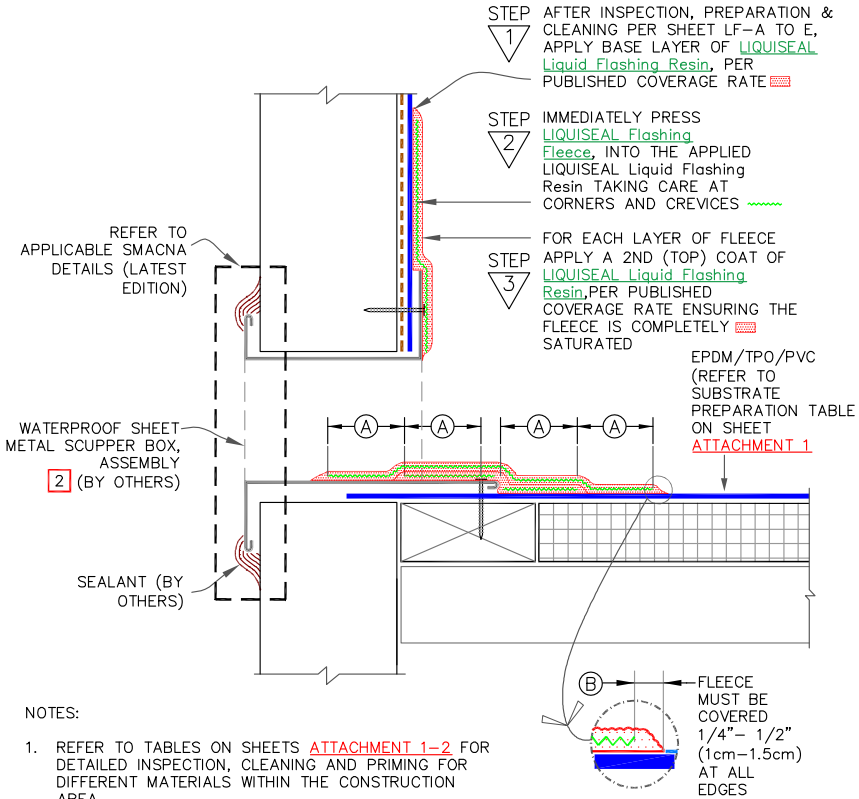

NOTES:

1. REFER TO TABLES ON SHEETS ATTACHMENT 1-2 FOR DETAILED INSPECTION, CLEANING AND PRIMING FOR DIFFERENT MATERIALS WITHIN THE CONSTRUCTION AREA.
2. WOOD NAILER MUST EXTEND PAST TOTAL WIDTH OF SHEET METAL FLANGE.
3. MECHANICAL FASTENERS MUST BE SECURED INTO STRUCTURAL CONCRETE, SOLID MASONRY OR PRESSURE TREATED WOOD BLOCKING.
4. DETAIL NOT FOR USE ON WARRANTY PROJECTS EXCEEDING 20-YEARS, UNLESS OTHERWISE SPECIFIED.

DIMENSIONS	cm	
(A)	3"	7.5 MIN.
(B)	1/4"	1 TO
	1/2"	1.5

	<p>THROUGH-WALL SCUPPER</p> <p>For additional information, refer to Specifications</p>	<p>DETAIL NO.</p> <p>LF-18.1</p> <p>LIQUID FLASHING</p>
--	--	---

LIQUID FLASHING

EPDM/TPO/PVC

INJECT VapAir Seal Flashing Foam PER SPECS & ALLOW TO SOLIDIFY. SHAVE PROTRUSIONS TO ACHIEVE SMOOTH SURFACE

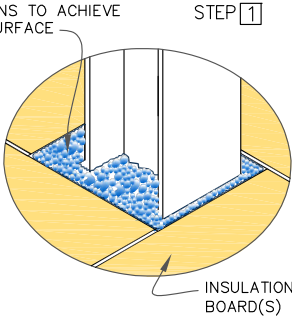

GRIND METAL WITH DIAMOND CUP GRINDING WHEEL

MEMBRANE SECURED WITH PLATES & FASTENERS PER SPECS

STEP 2

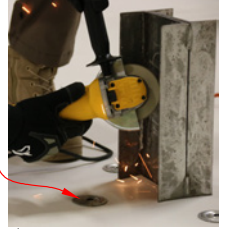

A

NOTE: ENSURE BODY OF PENETRATIONS & WELDS ARE COMPLETELY WATERPROOF.



DIAMOND CUP GRINDING WHEEL

STEP 3



C

USE SAND PAPER GRIT# 60 TO ABRAD THE MEMBRANE SURFACE.

STEP 4



D

REMOVE ALL GRINDING DUST, CLEAN METAL & MEMBRANE WITH CLEAN RAGS & MEMBRANE CLEANER.

STEP 5

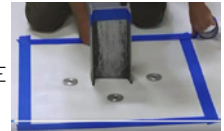

E

USE PAINTER'S TAPE AND TAPE OFF THE FLASHING AREA.

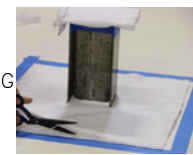

G

MEASURING, CUTTING & DRY FITTING TECHNIQUE

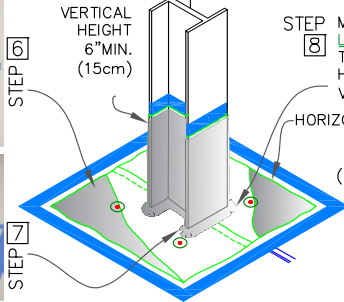

STEP 8 MAKE FINGER CUTS 2" (5cm) LONG IN LIQUISEAL Flashing Fleece AS SHOWN. THE FINGERS WILL REST ON THE HORIZONTAL SURFACE. SEE ENLARGED VIEW "I" ON PAGE 2 OF 2.

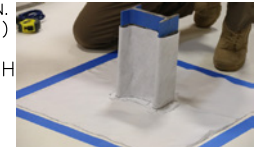

H

<ul style="list-style-type: none"> ROOF MEMBRANE LIQUISEAL Flashing Fleece LIQUISEAL Liquid Flashing Resin SEE NOTE(S) 	<p>STEEL I-BEAM FLASHING (PAGE 1 OF 2)</p> <p>For additional information, refer to Specifications</p>	<p>DETAIL NO. LF-30.1</p> <p>LIQUID FLASHING</p>
--	---	---

LIQUID FLASHING

EPDM/TPO/PVC

SACHET MIXING AND PRIMER APPLICATION

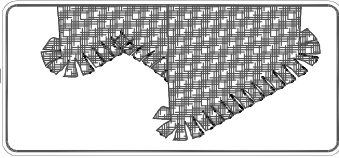

STEP 9

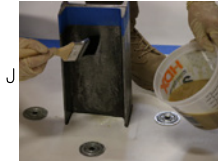

PRIME I-BEAM AND METAL PLATES. ENSURE AMBIENT AIR TEMPERATURE IS 40' & RISING. ALLOW PRIMER TO CURE UNTIL TACK-FREE.

STEP 10

APPLY 1ST COAT OF LIQUISEAL Liquid Flashing Resin & INSTALL LIQUISEAL Flashing Fleece ON VERTICAL SURFACES.

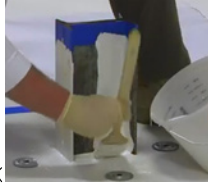

K

FLASHING FINAL INSTALLATION

STEP 11



IMMEDIATELY APPLY A 2ND COAT OF LIQUISEAL Liquid Flashing Resin ENSURING THE FLEECE IS COMPLETELY SATURATED.

L

APPLY 1ST COAT OF RESIN AND INSTALL FLEECE ON HORIZONTAL SURFACES. IMMEDIATELY APPLY A 2ND COAT OF RESIN ENSURING FLEECE IS COMPLETELY SATURATED.

STEP 12

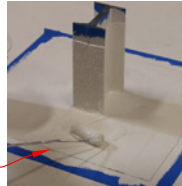

M

STEP 13

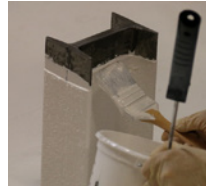

N

TOUCH UP AS NEEDED TO ENSURE ENTIRE FLEECE IS COMPLETELY SATURATED.

FLEECE MUST BE COVERED 1/4" - 1/2" (1cm - 1.5cm) BEYOND EDGES

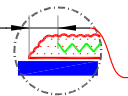

STEP 14

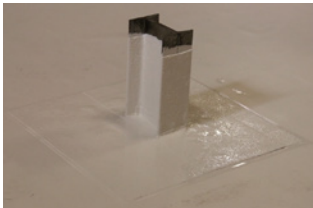





O

REMOVE TAPE IMMEDIATELY ENSURING THAT RESIN EXTENDS 1/4" - 1/2" (1cm - 1.5cm) BEYOND EDGE OF FLEECE

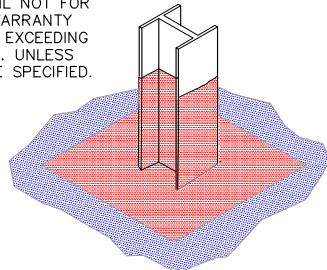
COMPLETED FLASHING

NOTE:
1. DETAIL NOT FOR USE ON WARRANTY PROJECTS EXCEEDING 20-YEARS, UNLESS OTHERWISE SPECIFIED.



<ul style="list-style-type: none">  ROOF MEMBRANE  LIQUISEAL Flashing Fleece  LIQUISEAL Liquid Flashing Resin  SEE NOTE(S) 	<p>STEEL I-BEAM FLASHING (PAGE 2 OF 2)</p> <p>For additional information, refer to Specifications</p>	<p>DETAIL NO. LF-30.1</p> <p>LIQUID FLASHING</p>
--	---	---

TPO Flashing Procedures Utilizing Sure-White EPDM Flashing Products

This is an alternate method for flashing Carlisle's Sure-Weld (TPO) membrane ONLY and is intended to be used in conjunction with the Carlisle Thermoplastic Specification and Details.

A. Description

Thermoplastic flashing procedures utilizing Carlisle Sure-White EPDM flashing products incorporates Pressure-Sensitive Elastoform Flashing, Pressure-Sensitive Inside/Outside Corners, Pressure Sensitive 'T'-Joint Covers, Pressure-Sensitive Pipe Seals, and Pressure-Sensitive Pourable Sealer Pockets. These Pressure-Sensitive products are used as an option and in lieu of welding TPO Flashing products for a **maximum warranty duration of 20 years**.

Carlisle's Sure-White EPDM Pressure-Sensitive products are comprised of uncured or cured White EPDM membrane laminated to fully cured Pressure-Sensitive adhesive.

B. Products

Products listed below can be used as part of this alternate flashing method in conjunction with **TPO Primer**.

- 1. Sure-White Pressure-Sensitive Elastoform Flashing:** A 6" X 100' and 9" or 12" wide by 50' long, 60-mil thick Sure-White uncured EPDM Flashing laminated to a 30-mil Pressure-Sensitive TAPE used in conjunction with TPO Primer.

Sure-White uncured Pressure-Sensitive Elastoform Flashing is used to flash inside and outside corners, pipes, scuppers and field fabricated pourable sealer pockets when the use of Carlisle pre-fabricated flashing accessories is not feasible.
- 2. Sure-White Pressure-Sensitive Corner/T-Joint Cover:** A 7" x 9" precut 60-mil thick (white) Elastoform Flashing with a 30-mil Pressure-Sensitive TAPE; used for inside and outside corners, to overlay field splice intersections, and to cover field splices at angle changes.
- 3. Sure-White Pressure-Sensitive Cured Cover Strip:** A 6" or 9" wide and 100' long and 12" wide by 50' long Sure-White 60-mil cured EPDM membrane laminated to a nominal 30-mil cured Pressure-Sensitive TAPE. The Cured Cover Strip is for flashing Carlisle Seam Fastening Plates.
- 4. Sure-White Pressure-Sensitive Pipe Seals** with Pressure-Sensitive TAPE on the deck flange. Pipe Seals are available in one size: 1" to 6".
- 5. Sure-White 20" Pressure-Sensitive Cured Flashing** - A 20" wide by 50' long Sure-White cured 60-mil thick EPDM membrane, with Pressure-Sensitive TAPE the full width already applied, used to flash curbs/skylights, etc.
- 6. Sure-White Pressure-Sensitive Curb Wrap** – A precut 20" wide by 50' long Sure-White cured 60-mil thick EPDM membrane with 6" wide Pressure-Sensitive TAPE along one edge to be used to flash curbs, skylights or parapet walls.
- 7. Sure-White Pourable Sealer Pocket:** A pre-fabricated Pourable Sealer Pocket which consists of a 2" wide plastic support strip with Pressure-Sensitive, adhesive backed uncured Elastoform Flashing; available in 6" diameter.
- 8. Sure-White SecurTAPE:** A 3" or 6" wide by 100' long splice tape used to bond Sure-White EPDM or Sure-Weld TPO membrane to Sure-Weld TPO membrane when flashing a curb or a wall with a separate section of membrane.
- 9. Low VOC EPDM and TPO Primer** - A low VOC (volatile organic compound) primer (less than 250 grams/liter) for priming of EPDM or TPO surfaces prior to application of FAT, Cover strip, SecurTAPE and all other pressure-sensitive products. Available in 1 gallon pails.

C. **Sure-White EPDM Flashing Installation Criteria**

General

1. When using Sure-White Pressure-Sensitive EPDM products on TPO membrane, TPO primer should be used to prepare the TPO membrane surface.
2. Sure-White Pressure-Sensitive Seam Tape is not to be used for field membrane seaming.
3. **Pressure-Sensitive Uncured Elastoform Flashing** must be limited to the overlayment of vertical seams (as required at angle changes), or to flash inside/outside corners, vent pipes, scuppers and other unusually shaped penetrations where the use of Pre-molded Pipe Seals is not practical.

NOTE: Even when working in warmer temperatures, in most cases a heat gun will be required to elevate the temperature of Pressure-Sensitive Uncured Flashing between 105°F and 110°F (40°C and 43°C) to permit proper forming of the uncured flashing.

4. **Inside/Outside Corners and 'T'-Joint Covers**

- a. Pressure-Sensitive Inside/Outside Corners and 'T'-Joint Covers are installed on both inside and outside corners in conjunction with TPO Primer.
- b. T-Joint Covers are installed at field splice intersections or at horizontal to vertical transitions of field splices in conjunction with TPO Primer.

5. **Other Penetrations**

- a. Flash pipes and round supports with Pressure-Sensitive Pipe Seals, when feasible, in accordance with the applicable detail.
- b. Form Field Fabricated Pipe Seals using Pressure-Sensitive Uncured Elastoform Flashing around pipes, round supports and structural steel tubing with corner radius greater than ¼".
- c. When flashing seamless metal posts, maximum 4" by 4", with a corner radius less than ¼", apply a field fabricated pipe flashing with a double vertical wrapping.
- d. For pipe clusters or unusually shaped penetrations, a pourable sealer pocket must be utilized.

THERMOPLASTIC MEMBRANE

TPO

WARRANTY REQUIREMENTS	20 YEAR WARRANTY	SEE DETAIL BELOW
	25 OR 30 YEAR WARRANTY	USE ONLY TPO PREFABRICATED ACCESSORIES

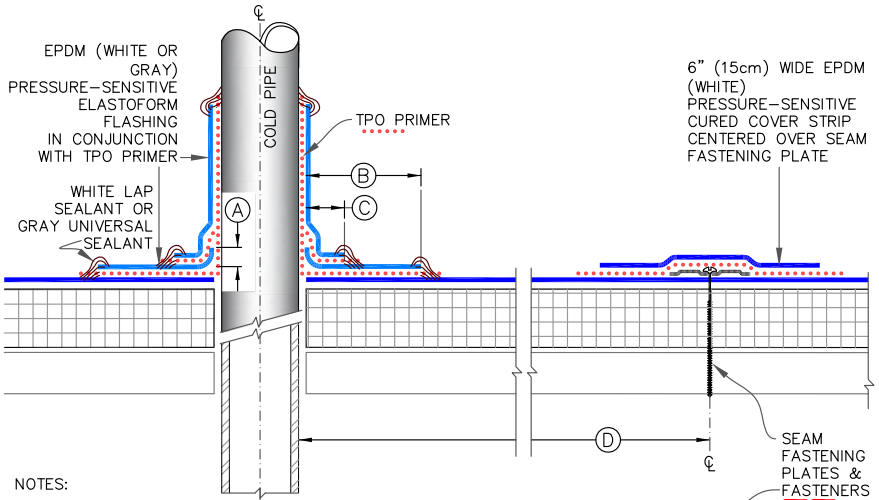

NOTES:

1. REMOVE ALL LEAD AND OTHER FLASHING BEFORE INSTALLING PRESSURE-SENSITIVE ELASTOFORM FLASHING.
2. TEMPERATURE OF THE PIPE PENETRATION MUST NOT EXCEED 180°F (82°C).
3. FASTENERS/PLATES ARE NOT REQUIRED ON ADHERED SYSTEMS UNLESS PIPE DIAMETER EXCEEDS 18" (50cm).
4. ON MECHANICALLY FASTENED SYSTEMS, HP-X FASTENERS AND PIRANHA PLATES OR HP-XTRA FASTENERS AND PIRANHA XTRA PLATES ARE REQUIRED OVER STEEL AND WOOD DECKS. ON CONCRETE DECKS, CD-10 OR HD 14-10 FASTENERS ARE USED WITH PIRANHA PLATES.
5. IN COLDER TEMPERATURES, A HEAT GUN MUST BE USED WHEN FORMING PRESSURE-SENSITIVE ELASTOFORM FLASHING.
6. APPLY TPO PRIMER PRIOR TO APPLYING UNIVERSAL SEALANT.

DIMENSIONS	cm	
(A)	1/2"	1.5
(B)	3"	7.5
(C)	1"	2.5
(D)	6"	15 TO
	12"	30
(E)	12"	30 MAX.

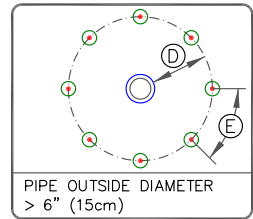
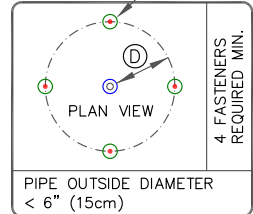

	FIELD FABRICATED PIPE SEAL WITH EPDM PRESSURE-SENSITIVE ELASTOFORM FLASHING		DETAIL NO.
	MAXIMUM WARRANTY: 20 YEARS		THERMOPLASTIC TPO

© 2023 Carlisle SynTec a division of Carlisle Construction Materials Incorporated

THERMOPLASTIC MEMBRANE

TPO

CAUTION

DETAIL NOT FOR USE ON 25 OR 30-YEAR WARRANTY PROJECTS. ACCEPTABLE EDGING SHALL CONFORM WITH THERMOPLASTIC UNIVERSAL DETAILS U-1B, U-1C, U-1D, U-1E OR U-1F.

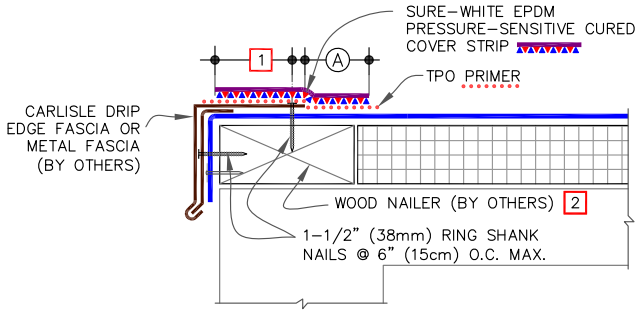

NOTES:

1. METAL FASCIA DECK FLANGE MUST BE TOTALLY COVERED BY SURE-WHITE EPDM PRESSURE-SENSITIVE COVER STRIP WITH MINIMUM 2" (5cm) COVERAGE PAST NAIL HEADS.
2. WOOD NAILER MUST EXTEND PAST TOTAL WIDTH OF METAL FASCIA DECK FLANGE.
3. TO REMOVE FINISHING OILS, SCRUB METAL FLANGE WITH WEATHERED MEMBRANE CLEANER; ALLOW TO DRY PRIOR TO APPLYING TPO PRIMER.
4. APPLY TPO PRIMER TO METAL FLANGE AND TPO MEMBRANE SURFACE PRIOR TO INSTALLING SURE-WHITE EPDM PRESSURE-SENSITIVE COVER STRIP.
5. WHEN METAL FASCIA BY OTHERS IS USED, FASTENER TYPE AND FASTENING FREQUENCY SHALL BE RECOMMENDED BY METAL EDGE MANUFACTURER.
6. T-JOINT COVERS ARE REQUIRED AT INTERSECTIONS WITH 60 MIL OR 80 MIL MEMBRANE.
7. THIS DETAIL IS NOT RECOMMENDED FOR ROOFS THAT ARE LIKELY TO EXPERIENCE SIGNIFICANT SNOW AND ICE UP-SLOPE FROM THE GUTTER /EDGE. REFER TO DETAILS U-1B OR U-1C.

DIMENSIONS	cm	
(A)	2"	5 MIN.
(B)	1/2 - 1"	1.5-2.5

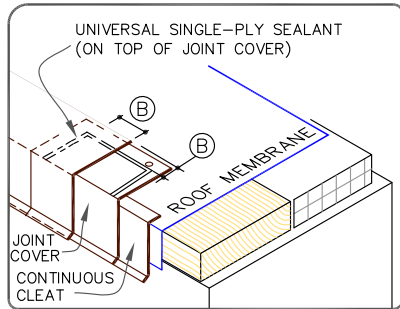

	SecurSeal DRIP EDGE FASCIA WITH SURE-WHITE EPDM		DETAIL NO.
	MAXIMUM WARRANTY: 20 YEARS		U-1AT
		THERMOPLASTIC TPO	

© 2023 Carlisle SynTec a division of Carlisle Construction Materials Incorporated

THERMOPLASTIC MEMBRANE

TPO

WARRANTY REQUIREMENTS	20 YEAR WARRANTY	USE MIN 3" (7.5cm) WIDE WHITE FACTORY-APPLIED TAPE OR	MIN 3" (7.5cm) WIDE FIELD-APPLIED SURE-WHITE SecurTAPE
	25 OR 30 YEAR WARRANTY	REFER TO CARLISLE TYPICAL TPO DETAIL U-2 .	

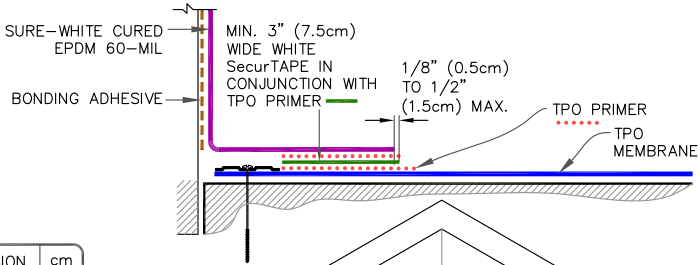

DIMENSION	cm
(A)	3" 7.5

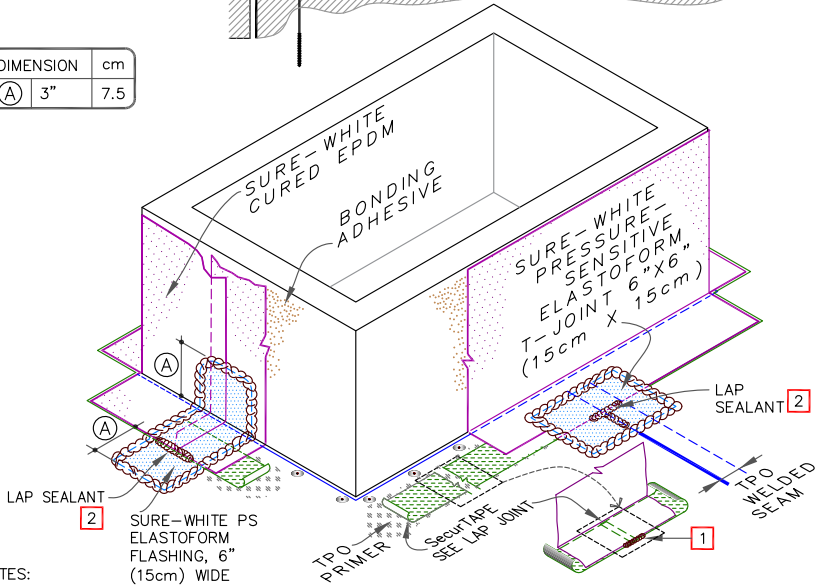

NOTES:

1. FIELD APPLIED SURE-WHITE SecurTAPE IS TO BE OVERLAPPED A MINIMUM OF 1" (2.5cm) AT THE ENDS OF EACH CUT PIECE. APPLY LAP SEALANT AT TAPE OVERLAPS 2" (5cm) IN BOTH DIRECTIONS.
2. APPLY SURE-WHITE LAP SEALANT ALONG THE LEADING EDGE OF THE MEMBRANE SPLICE UNDER THE T-JOINT COVER, COVERING THE EXPOSED SPLICE TAPE 1/2" (1.5cm) IN ALL DIRECTIONS FROM THE SPLICE INTERSECTION.
3. INSTALL OUTSIDE CORNERS PER DETAIL [U-15GT](#) OR [U-15ET](#).

	CURB/WALL WITH SURE-WHITE EPDM & SURE-WHITE SecurTAPE		DETAIL NO.
	MAXIMUM WARRANTY: 20 YEARS		U-5AT

THERMOPLASTIC MEMBRANE

TPO

WARRANTY REQUIREMENTS	20 YEAR WARRANTY	SEE DETAIL BELOW
	25 OR 30 YEAR WARRANTY	REFER TO CARLISLE TYPICAL APPLICABLE TPO DETAIL(S) U-5A, U-5B & U-5C FOR REQUIRED CURB DETAIL

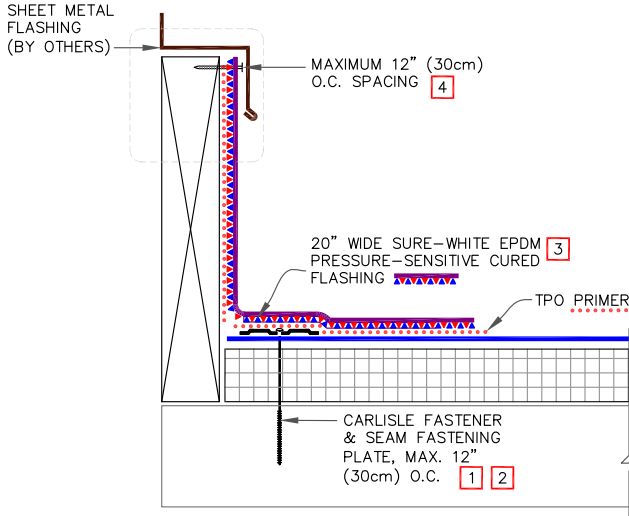

NOTES:

- ON MECHANICALLY FASTENED ROOFING SYSTEMS, HP-X FASTENERS AND HP-X SEAM PLATES ARE REQUIRED OVER STEEL DECKS.
- SEAM FASTENING PLATES/FASTENERS MAY BE INSTALLED INTO THE VERTICAL SUBSTRATE.
- IF THE VERTICAL SPLICE ON THE CURB FLASHING IS NOT LOCATED AT THE CORNER, A 6" (15cm) WIDE PRESSURE-SENSITIVE ELASTOFORM OR A T-JOINT FLASHING, IN CONJUNCTION WITH TPO PRIMER MUST BE CENTERED OVER FIELD SPLICE AT ANGLE CHANGE.
- WHEN MECHANICAL FASTENERS ARE USED TO PENETRATE THE METAL COUNTER-FLASHING, USE EPDM WASHERS. APPLY WATER CUT-OFF MASTIC UNDER THE COUNTER-FLASHING OR APPLY SEALANT ON THE FASTENERS' HEADS.

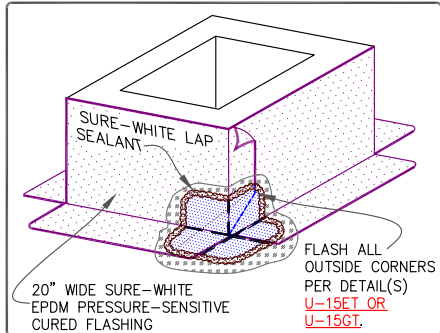

	CURB WITH 20" WIDE SURE-WHITE EPDM PRESSURE-SENSITIVE CURED FLASHING		DETAIL NO.
	MAXIMUM WARRANTY: 20 YEARS		U-5BT
		THERMOPLASTIC TPO	

© 2023 Carlisle SynTec a division of Carlisle Construction Materials Incorporated

THERMOPLASTIC MEMBRANE TPO

WARRANTY REQUIREMENTS	20 YEAR WARRANTY	SEE DETAIL BELOW
	25 OR 30 YEAR WARRANTY	REFER TO CARLISLE TYPICAL TPO DETAIL U-8A . NO FIELD-FABRICATION ALLOWED FOR 25/30 YEAR ROOF.

DIMENSIONS	cm	
(A)	1/2"	1.5 TO
	6"	15
(B)	3"	7.5

NOTES:

1. REMOVE ALL LEAD AND OTHER FLASHING BEFORE INSTALLING PRESSURE-SENSITIVE PIPE SEAL.
2. TEMPERATURE OF THE PIPE PENETRATION MUST NOT EXCEED 180°F (82°C).
3. PRE-MOLDED PIPE FLASHING MUST HAVE INTACT RIB AT THE TOP EDGE REGARDLESS OF PIPE DIAMETER.
4. DECK FLANGES OF THE PRESSURE-SENSITIVE PIPE SEAL SHALL NOT BE OVERLAPPED, CUT OR APPLIED OVER ANY ANGLE CHANGE.
5. WHEN A FIELD SPlice INTERSECTS A PIPE SEAL, APPLY SURE-WHITE LAP SEALANT ALONG THE EDGE OF THE MEMBRANE SPlice COVERING THE EXPOSED SPlice TAPE 1/2" (1.5cm) IN EACH DIRECTION FROM THE SPlice INTERSECTION & OVERLAY WITH A 7"x9" (18cm X 23cm) T-JOINT COVER.
6. ON MECHANICALLY-FASTENED ROOFING SYSTEMS, ADDITIONAL MEMBRANE SECUREMENT IS REQUIRED. REFER TO TPO [DETAIL U-8A](#).

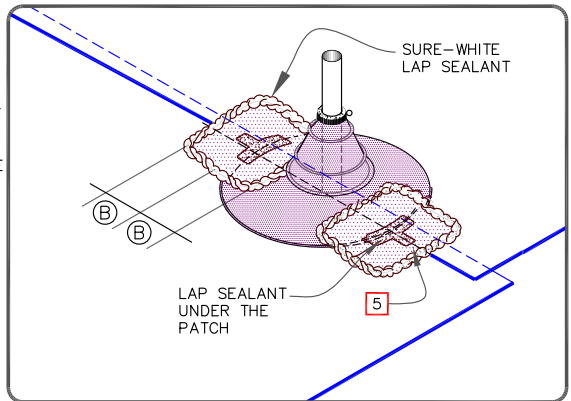
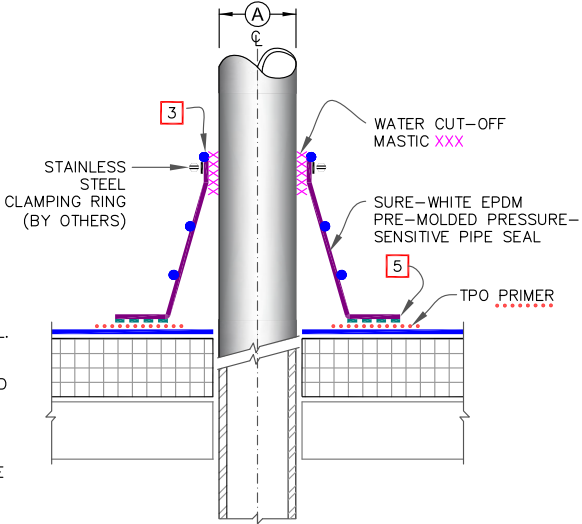

	PIPE: PRE-MOLDED PRESSURE-SENSITIVE SURE-WHITE EPDM PIPE SEAL		DETAIL NO. U-8AT
	MAXIMUM WARRANTY: 20 YEARS		THERMOPLASTIC TPO

THERMOPLASTIC MEMBRANE

TPO

WARRANTY REQUIREMENTS	20 YEAR WARRANTY	SEE DETAIL BELOW
	25 OR 30 YEAR WARRANTY	REFER TO CARLISLE TPO DETAIL U-8E.

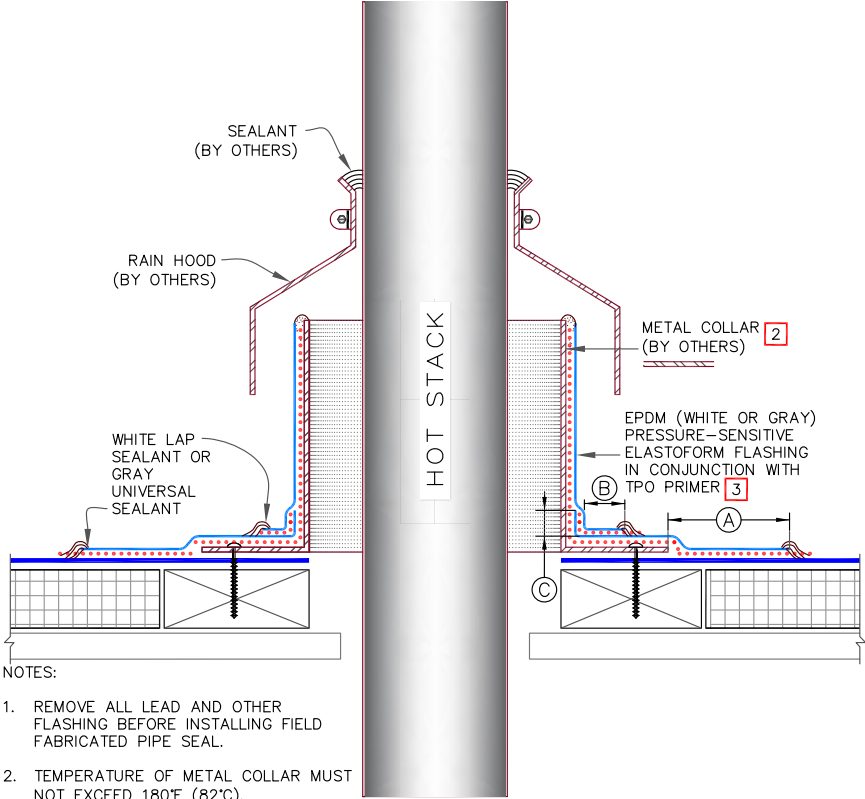

NOTES:

1. REMOVE ALL LEAD AND OTHER FLASHING BEFORE INSTALLING FIELD FABRICATED PIPE SEAL.
2. TEMPERATURE OF METAL COLLAR MUST NOT EXCEED 180°F (82°C).
3. TPO PRIMER MUST BE APPLIED TO THE MATING SURFACES PRIOR TO APPLYING SURE-WHITE PRESSURE-SENSITIVE ELASTOFORM FLASHING AND PRIOR TO APPLYING UNIVERSAL SEALANT.
4. IN COLDER TEMPERATURES, A HEAT GUN MUST BE USED WHEN FORMING PRESSURE-SENSITIVE ELASTOFORM FLASHING.

DIMENSIONS	cm	
(A)	3"	7.5 MIN.
(B)	1"	2.5 MIN.
(C)	1/2"	1.5 MIN.

	HOT STACK: FIELD FABRICATED FLASHING WITH EPDM PS ELASTOFORM	 DETAIL NO. U-8DT
	MAXIMUM WARRANTY: 20 YEARS	

© 2023 Carlisle SynTec a division of Carlisle Construction Materials Incorporated

THERMOPLASTIC MEMBRANE

TPO

WARRANTY REQUIREMENTS

DETAIL NOT FOR USE ON 25-30 YEAR WARRANTY ROOFS. SEE DETAIL [U-12A](#) OR [U-12B](#) FOR TPO/PVC.

FASTENERS AND PLATES ARE REQUIRED AT 6" (15cm) O.C. FOR ADHERED SYSTEMS WITH WARRANTY WIND SPEED COVERAGE GREATER THAN 90 MPH AND FOR ALL PROJECTS WITH WARRANTIES GREATER THAN 20 YEARS.

SEE NOTE # 2.

NOTES:

1. SEAM FASTENING PLATE/FASTENER MAY BE INSTALLED INTO THE STRUCTURAL DECK.
2. FOR PROJECTS WITH 20-YEAR WARRANTY, USE 3" (7.5 cm) WIDE FIELD APPLIED SecurTAPE.

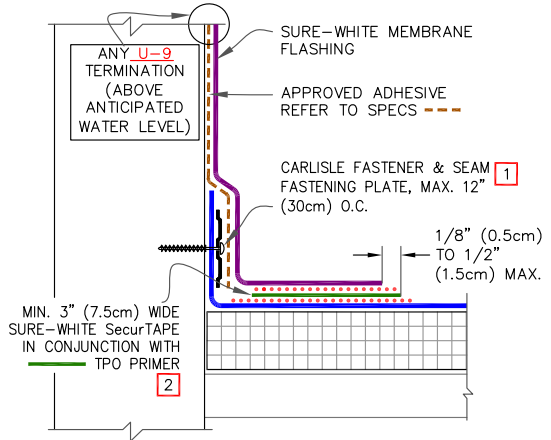

DIMENSION	cm
(A) 3"	7.5

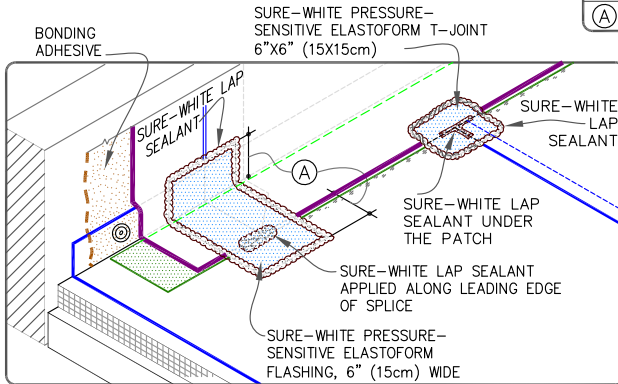

	PARAPET/CURB WITH SURE-WHITE EPDM & SURE-WHITE SecurTAPE MAXIMUM WARRANTY: 20 YEARS		DETAIL NO. U-12AT
			THERMOPLASTIC TPO

© 2023 Carlisle SynTec a division of Carlisle Construction Materials Incorporated

THERMOPLASTIC MEMBRANE

TPO

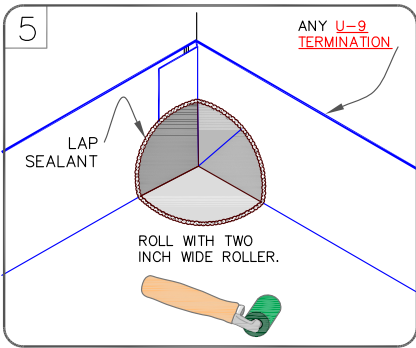
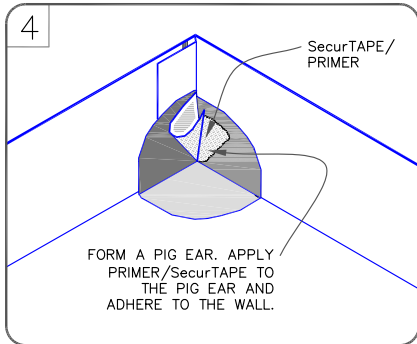
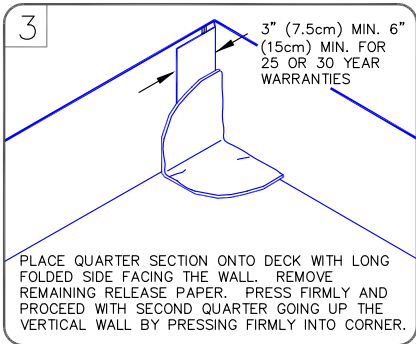
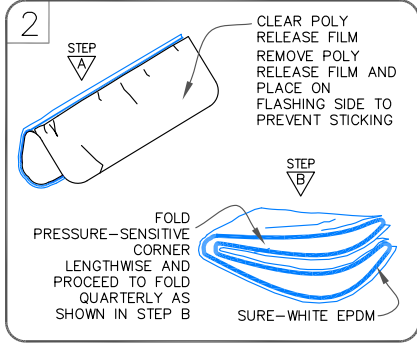
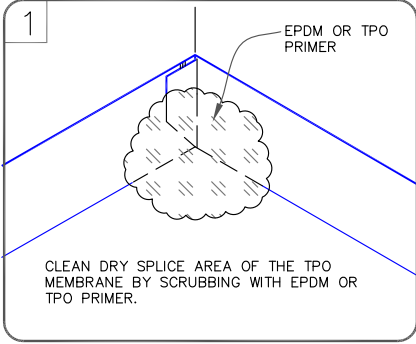

NOTE:

1. TPO PRIMER MUST BE APPLIED TO ALL SPLICE AREAS AND FOR EACH LAYER OF PRESSURE-SENSITIVE FLASHING.

WARRANTY REQUIREMENTS	DETAIL NOT FOR USE ON 25-30 YEAR WARRANTY ROOFS.
-----------------------	--

	SURE-WHITE PRESSURE-SENSITIVE INSIDE CORNER WITH CONTINUOUS TPO WALL FLASHING		DETAIL NO.
	MAXIMUM WARRANTY: 20 YEARS		U-15CT
		THERMOPLASTIC TPO	

THERMOPLASTIC MEMBRANE

TPO

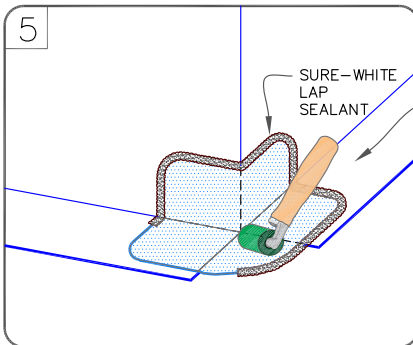
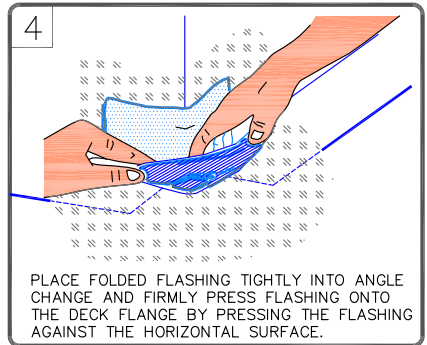
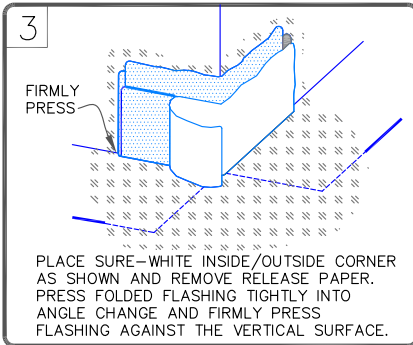
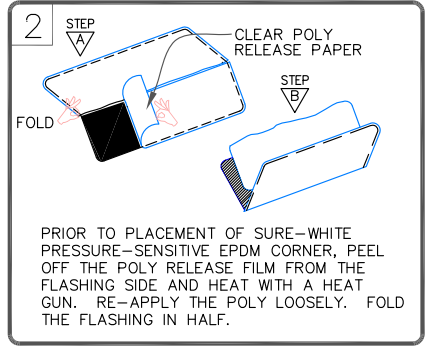
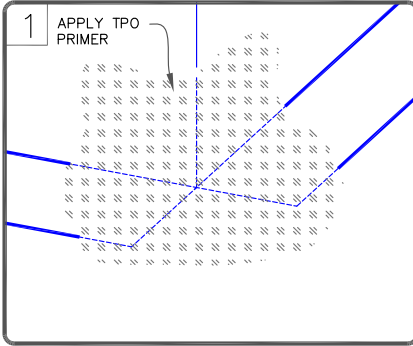

AFTER ADHERING, ROLL WITH A TWO INCH WIDE ROLLER. PAY PARTICULAR ATTENTION TO THE STEP OFFS AND ANGLE CHANGES.

IN COLDER TEMPERATURES, A HEAT GUN MUST BE USED WHEN FORMING PRESSURE-SENSITIVE ELASTOFORM FLASHING.

WARRANTY REQUIREMENTS DETAIL NOT FOR USE ON 25-30 YEAR WARRANTY ROOFS.

	OUTSIDE CORNER WITH PRE-CUT PRESSURE-SENSITIVE FLASHING (OPTION 1) MAXIMUM WARRANTY: 20 YEARS		DETAIL NO. U-15ET
			THERMOPLASTIC TPO

THERMOPLASTIC MEMBRANE

TPO

1

TPO OR SURE-WHITE EPDM MEMBRANE

FASTEN MEMBRANE AND FLASH CURB OR WALL WITH MEMBRANE FOLLOWING STANDARD PROCEDURES USING BONDING ADHESIVE AND SURE-WHITE SecurTAPE OR HOT AIR WELDING.

2

CENTER FOLD LINE

CUT A 9"x9" (23cm x 23cm) SECTION OF EPDM (WHITE OR GRAY) PRESSURE-SENSITIVE ELASTOFORM FLASHING AND MAKE ROUNDED CORNERS AS SHOWN.

3

FIRMLY PRESS

AFTER APPLYING TPO PRIMER, REMOVE AND REPLACE POLY BACKING. ON FLASHING SIDE, FOLD 9"x9" (23cm x 23cm) FLASHING IN HALF WITH ROUNDED PORTION TURNED UP. CENTER FLASHING ON CORNER AND FIRMLY PRESS AGAINST VERTICAL SURFACE.

4

ROLL AND CREASE FLASHING TIGHTLY INTO ANGLE CHANGE AND FIRMLY ROLL FLASHING ONTO THE DECK MEMBRANE.

5

WHITE LAP SEALANT OR GRAY UNIVERSAL SEALANT

AFTER ADHERING, ROLL WITH A TWO INCH WIDE ROLLER. PAY PARTICULAR ATTENTION TO THE STEP OFFS AND ANGLE CHANGES.

IN COLDER TEMPERATURES, A HEAT GUN MUST BE USED WHEN FORMING PRESSURE-SENSITIVE ELASTOFORM FLASHING.

APPLY TPO PRIMER PRIOR TO APPLYING UNIVERSAL SEALANT.



OUTSIDE CORNER WITH EPDM PRESSURE-SENSITIVE ELASTOFORM FLASHING (OPTION 2)
 MAXIMUM WARRANTY: 20 YEARS



DETAIL NO.

U-15GT

THERMOPLASTIC TPO

THERMOPLASTIC MEMBRANE

TPO

WARRANTY REQUIREMENTS

DETAIL NOT FOR USE ON 25-30 YEAR WARRANTY ROOFS. SEE THERMOPLASTIC DETAIL [U-16A](#).

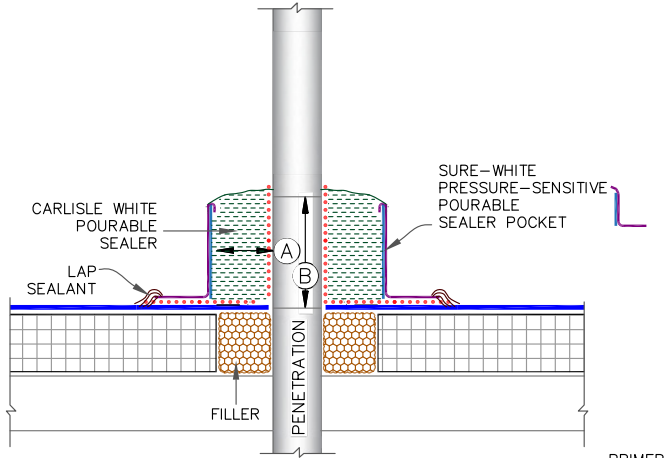

NOTES:

1. THE MAXIMUM ALLOWABLE SURFACE TEMPERATURE OF THE PENETRATION SHALL NOT EXCEED 180°F (82°C).
2. ALL DEBRIS (PAINT, RUST, LEAD, OTHER FLASHINGS, ETC.) MUST BE REMOVED FROM THE PENETRATION.
3. PENETRATIONS, MEMBRANE, FLASHING AND METAL (INSIDE POCKET) MUST BE PRIMED WITH TPO PRIMER PRIOR TO APPLYING POURABLE SEALER. DO NOT PRIME THE BLUE PLASTIC SUPPORT STRIP.
4. POURABLE SEALER MUST COMPLETELY FILL POURABLE SEALER POCKET TO PREVENT PONDING OF WATER.
5. POURABLE SEALER MUST CONTACT PRIMED PRESSURE-SENSITIVE ELASTOFORM FLASHING AND DECK MEMBRANE.
6. SECUREMENT IS REQUIRED FOR POURABLE SEALER POCKETS WHICH ARE GREATER THAN 18" (46cm) IN DIAMETER. REFER TO SPECIFICATIONS.
7. ON MECHANICALLY-FASTENED ROOFING SYSTEMS, ADDITIONAL MEMBRANE SECUREMENT IS REQUIRED (SIMILAR TO [DETAIL U-8A](#)) REGARDLESS OF SIZE OR DIAMETER.
8. PIPE CLUSTERS MUST HAVE MINIMUM 1" (2.5cm) CLEARANCE BETWEEN PENETRATIONS.

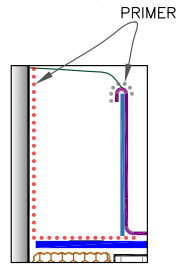

MANDATORY TPO PRIMER AT ALL INTERFACES OF POURABLE SEALER EXCEPT BLUE PLASTIC SUPPORT STRIP

DIMENSIONS	cm	
(A)	1"	2.5 MIN.
(B)	2"	5 MIN.

	PRESSURE-SENSITIVE POURABLE SEALER POCKET	DETAIL NO. U-16BT
	MAXIMUM WARRANTY: 20 YEARS	

© 2023 Carlisle SynTec a division of Carlisle Construction Materials Incorporated

THERMOPLASTIC MEMBRANE TPO

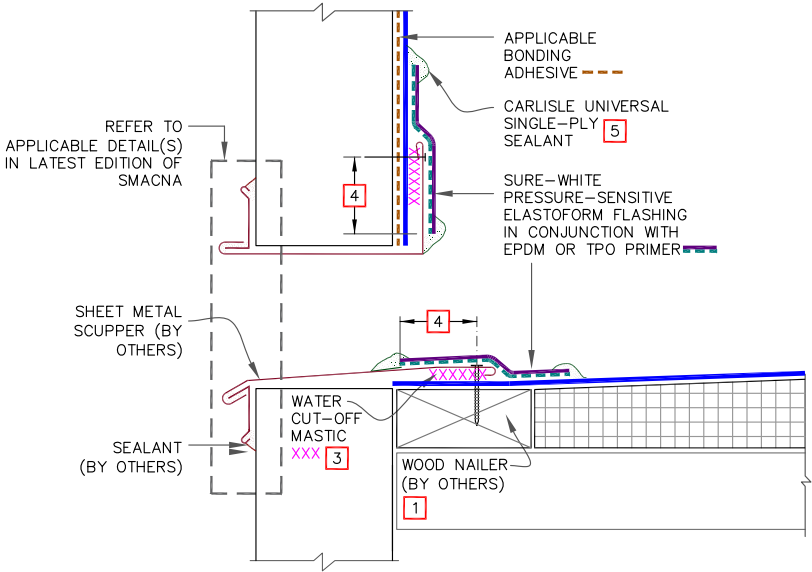

NOTES:

1. WOOD NAILERS ARE INSTALLED AT SCUPPERS TO SECURE METAL SLEEVE AND MUST EXTEND PAST THE WIDTH OF METAL SLEEVE FLANGE.
2. METAL SCUPPER BOX MUST HAVE CONTINUOUS FLANGES WITH ROUNDED CORNERS, SOLDER ALL SCUPPER SEAMS WATER-TIGHT.
3. WATER CUT-OFF MASTIC UNDER SCUPPER FLANGES MUST BE UNDER CONSTANT COMPRESSION.
4. SCUPPER FLANGES MUST BE TOTALLY COVERED BY PRESSURE-SENSITIVE ELASTOFORM FLASHING WITH MINIMUM 2" (5cm) COVERAGE PAST NAIL HEAD.
5. UNIVERSAL SINGLE-PLY SEALANT IS REQUIRED AT FLASHING EDGES ON SCUPPER EDGE. TPO PRIMER MUST BE USED TO PREPARE SURFACES PRIOR TO THE APPLICATION OF SEALANT.

TPO ONLY
(NOT FOR PVC)

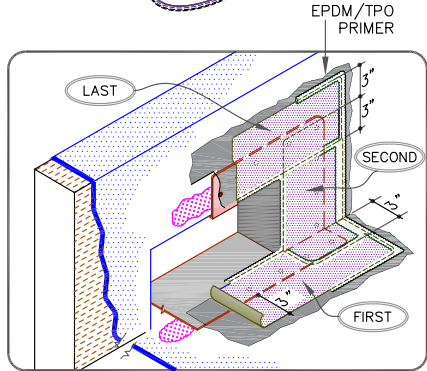

SCUPPER AT DECK WITH PRESSURE SENSITIVE ELASTOFORM

MAXIMUM WARRANTY: 20 YEARS



DETAIL NO.

U-18BT

THERMOPLASTIC TPO

VacuSeal Vent Secured Roofing System

ROOF ASSEMBLY WITHOUT NEW INSULATION

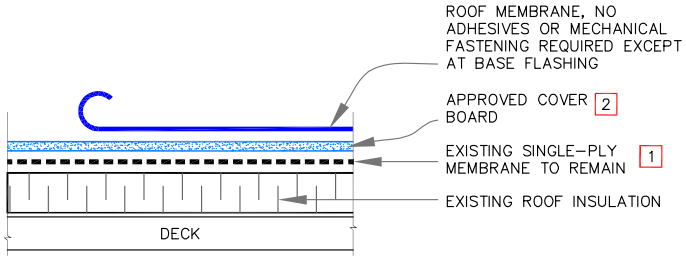

NOTE:

- EXISTING ROOF MEMBRANE MAY BE USED AS AN AIR BARRIER. IT WILL REQUIRE THOROUGH INSPECTION FOR BREACHES, DAMAGES, AND AIR TIGHTNESS OF EXISTING FLASHING. SEAL ALL DEFICIENT CONDITIONS TO ACHIEVE AN AIRTIGHT AIR BARRIER.
- DIRECT OVERLAYS (NO NEWLY INSTALLED INSULATION OR COVERBOARD) MAY BE ACCEPTABLE DEPENDING ON THE EXISTING WATERPROOFING LAYER AND NEWLY INSTALLED MEMBRANE. REFERENCE SUBSTRATE CRITERIA FOR VACUSEAL REROOF (RECOVER, NO TEAR-OFF) CHART FOR DETAILS.

ROOF ASSEMBLY WITH NEW INSULATION

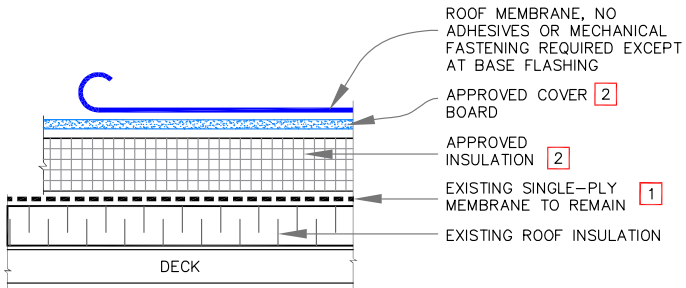

	ROOF ASSEMBLY OVER EXISTING SINGLE-PLY ROOF		DETAIL NO.
	MAXIMUM WARRANTY: 20 YEARS		V-0.1

© 2023 Carlisle SynTec a division of Carlisle Construction Materials Incorporated

VacuSeal Vent Secured Roofing System

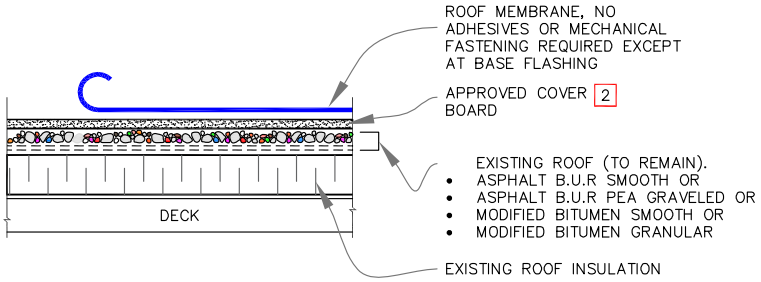

NOTES:

1. EXISTING ROOF MEMBRANE MAY BE USED AS AN AIR BARRIER. IT WILL REQUIRE THOROUGH INSPECTION FOR BREACHES, DAMAGES, BLISTERS, WRINKLES AND AIR TIGHTNESS OF EXISTING FLASHING. SEAL ALL DEFICIENT CONDITIONS TO ACHIEVE AN AIRTIGHT AIR BARRIER.
2. DIRECT OVERLAYS (NO NEWLY INSTALLED INSULATION OR COVERBOARD) MAY BE ACCEPTABLE DEPENDING ON THE EXISTING WATERPROOFING LAYER AND NEWLY INSTALLED MEMBRANE. REFERENCE SUBSTRATE CRITERIA FOR VACUSEAL REROOF (RECOVER, NO TEAR-OFF) CHART FOR DETAILS.
3. FOR NEW ASSEMBLY OVER COAL TAR PITCHED ROOF, CONTACT CARLISLE SYNTEC.
4. LOOSE GRAVEL OR GRANULES MUST BE REMOVED AND THE SURFACE SHALL BE LEVELED.

	ROOF ASSEMBLY OVER EXISTING ASPHALTIC ROOF		DETAIL NO. V-0.2
	MAXIMUM WARRANTY: 20 YEARS		

© 2023 Carlisle SynTec a division of Carlisle Construction Materials Incorporated

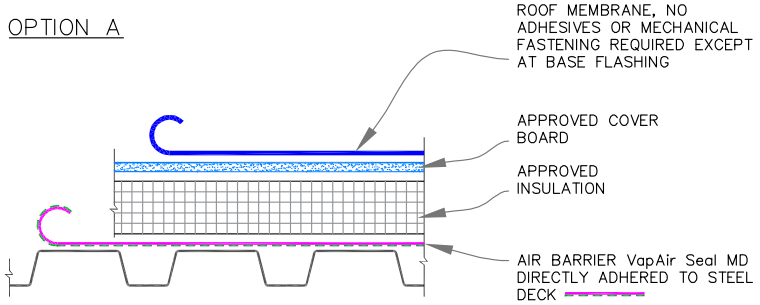

VacuSeal Vent Secured Roofing System

OPTION A

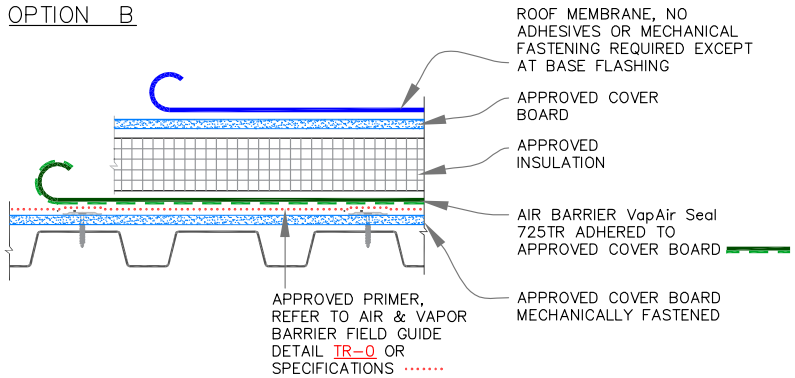

OPTION B



	ROOF ASSEMBLY OVER STEEL DECK		DETAIL NO.
	MAXIMUM WARRANTY: 20 YEARS		V-0.3

© 2023 Carlisle SynTec a division of Carlisle Construction Materials Incorporated

VacuSeal Vent Secured Roofing System

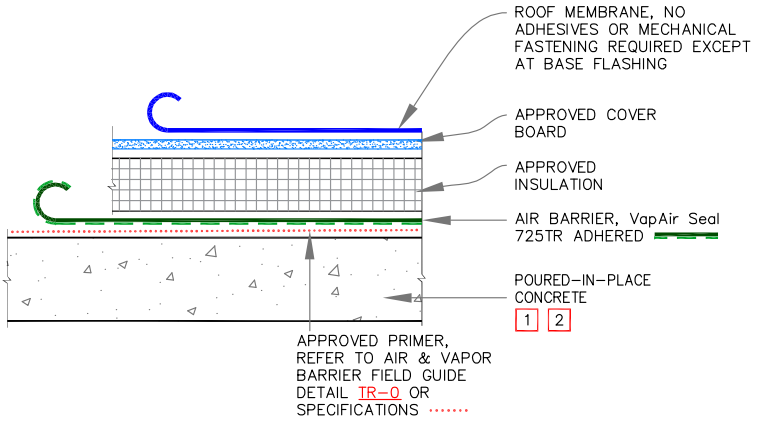

NOTES:

1. THE SUBSTRATE MAY NOT REQUIRE AN ADDITIONAL LAYER OF AIR BARRIER. TO ENSURE THAT A CONTINUOUS AIR-SEAL IS PROVIDED, THE SUBSTRATE MUST BE INSPECTED FOR BREACHES FOR AIR INFILTRATION AT CRACKS, JOINTS, PENETRATIONS, ROOF EDGES, PARAPET WALLS, AND SIMILAR CONDITIONS.

	ROOF ASSEMBLY OVER POURED-IN-PLACE CONCRETE DECK		DETAIL NO.
	MAXIMUM WARRANTY: 20 YEARS		V-0.4

© 2023 Carlisle SynTec a division of Carlisle Construction Materials Incorporated

VacuSeal Vent Secured Roofing System

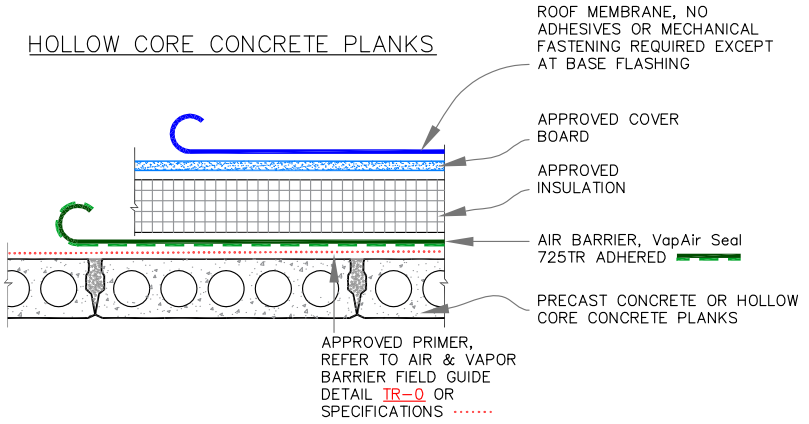

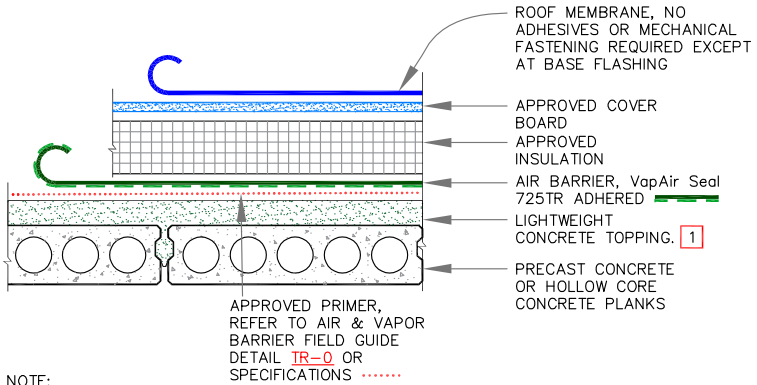

HOLLOW CORE CONCRETE PLANKS WITH TOPPING



NOTE:

1. THE SUBSTRATE MAY NOT REQUIRE AN ADDITIONAL LAYER OF AIR BARRIER WHEN CONCRETE TOPPING EXISTS. TO ENSURE THAT A CONTINUOUS AIR-SEAL IS PROVIDED, THE SUBSTRATE MUST BE INSPECTED FOR BREACHES FOR AIR INFILTRATION AT CRACKS, JOINTS, PENETRATIONS, ROOF EDGES, PARAPET WALLS, AND SIMILAR CONDITIONS & PROPER REPAIRS MUST BE PERFORMED.

	ROOF ASSEMBLY OVER CONCRETE PLANKS		DETAIL NO.
	MAXIMUM WARRANTY: 20 YEARS		V-0.5

© 2023 Carlisle SynTec a division of Carlisle Construction Materials Incorporated

VacuSeal Vent Secured Roofing System

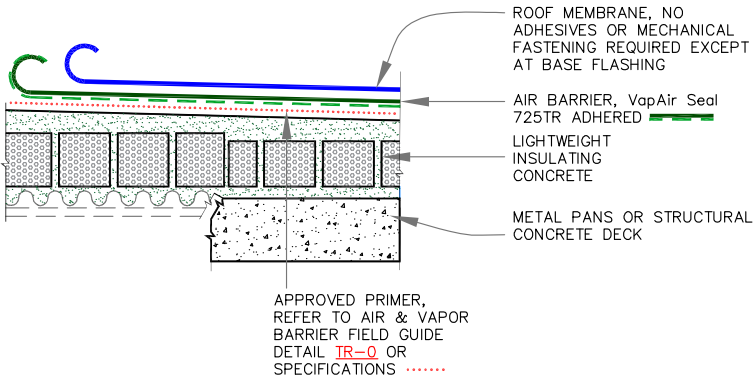

NOTE:

1. THE SUBSTRATE MAY NOT REQUIRE AN ADDITIONAL LAYER OF AIR BARRIER WHEN CONCRETE TOPPING EXISTS. TO ENSURE THAT CONCRETE SUBSTRATE PROVIDES A CONTINUOUS AIR-SEAL, THE SUBSTRATE MUST BE INSPECTED FOR AIR INFILTRATION, INSPECT FOR BREACHES CRACKS, JOINTS, PENETRATIONS, ROOF EDGES, PARAPET WALLS JUNCTIONS, AND SIMILAR CONDITIONS. PROPER REPAIRS MUST BE PERFORMED TO CREATE AN AIR BARRIER.

	ROOF ASSEMBLY OVER LIGHTWEIGHT CONCRETE DECK		DETAIL NO.
	MAXIMUM WARRANTY: 20 YEARS		V-0.6

© 2023 Carlisle SynTec a division of Carlisle Construction Materials Incorporated

VacuSeal Vent Secured Roofing System

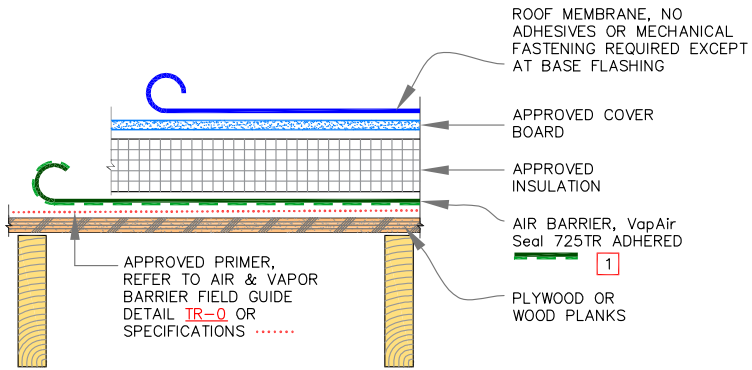

NOTES:

1. TO AVOID POTENTIAL DAMAGE TO AIR AND VAPOR BARRIER, PROTRUDING NAILS/FASTENERS SHALL BE REMOVED AND REPLACED WITH HEAVY GAUGE THREADED FASTENERS.
2. AS AN OPTION, THE AIR AND VAPOR BARRIER MAY BE ADHERED TO MECHANICALLY FASTENED SECURROCK OR DensDeck PRIME COVER BOARD.

	ROOF ASSEMBLY OVER WOOD DECK		DETAIL NO.
	MAXIMUM WARRANTY: 20 YEARS		V-0.7

© 2023 Carlisle SynTec a division of Carlisle Construction Materials Incorporated

VacuSeal Vent Secured Roofing System

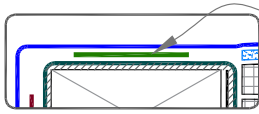

IN LIEU OF BONDING ADHESIVE, 3" (7.5cm) WIDE SecurTAPE MAY BE USED WITH PRIMER TO SEAL BOTH THE MEMBRANES

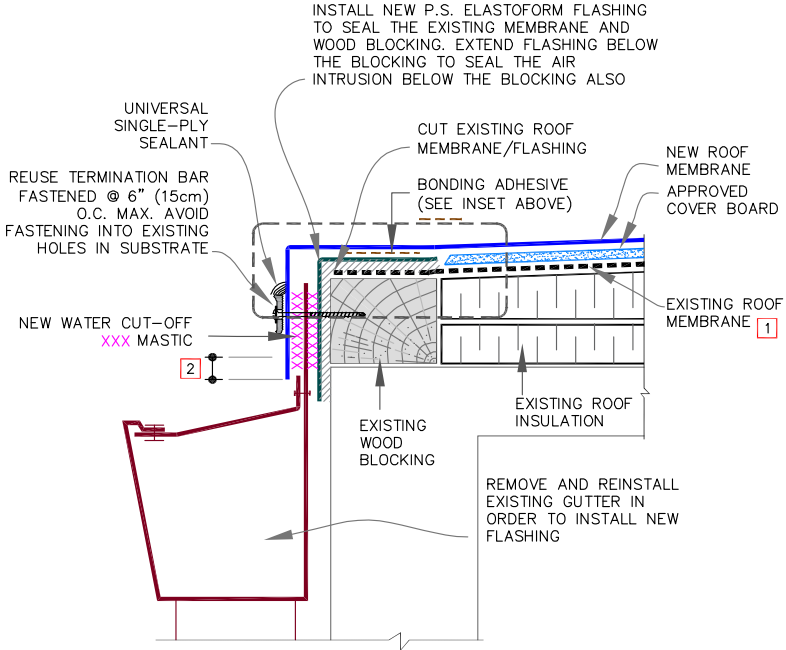

NOTES:

1. EXISTING ROOF MEMBRANE MAY BE USED AS AN AIR BARRIER. IT WILL REQUIRE THOROUGH INSPECTION FOR BREACHES, DAMAGES, AND AIR TIGHTNESS OF EXISTING FLASHING. SEAL ALL DEFICIENT CONDITIONS TO ACHIEVE AN AIRTIGHT AIR BARRIER.
2. ALLOW MEMBRANE SHEET TO EXTEND 1/2" (1.5cm) MINIMUM BELOW THE METAL TERMINATION BAR.

	ROOF EDGE: ROOF RECOVER		DETAIL NO.
	MAXIMUM WARRANTY: 20 YEARS		V-1.1

VacuSeal Vent Secured Roofing System

IN LIEU OF BONDING ADHESIVE,
3" (7.5cm) WIDE SecurTAPE
MAY BE USED WITH PRIMER TO
SEAL BOTH THE MEMBRANES

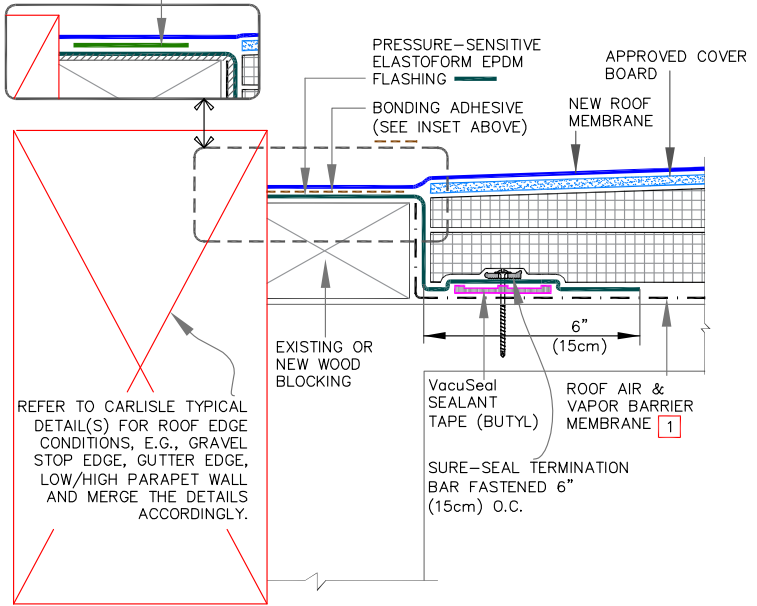

NOTES:

1. USE VapAir Seal 725TR AIR AND VAPOR BARRIER ON CONCRETE DECKS.
2. IN CASE OF METAL DECK, COORDINATE WITH CARLISLE.

	ROOF EDGE: TEAR-OFF & REROOFING		DETAIL NO.
	MAXIMUM WARRANTY: 20 YEARS		V-1.2

© 2023 Carlisle SynTec a division of Carlisle Construction Materials Incorporated

VacuSeal Vent Secured Roofing System

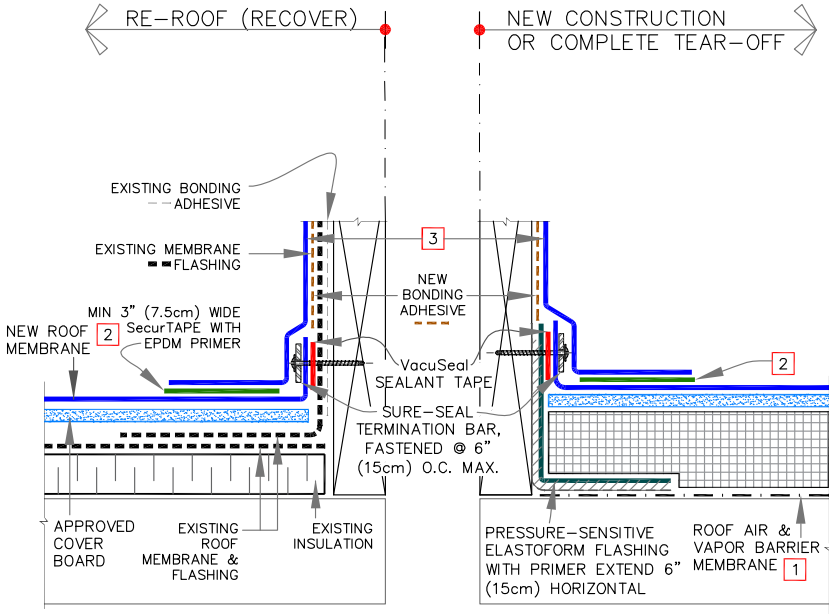

NOTES:

1. ON STEEL DECKS DIRECTLY ADHERE VapAir Seal MD. USE VapAir Seal 725TR ON CONCRETE & WOOD DECKS OR DECKS WITH APPROVED COVER BOARDS.
2. FOR ADDITIONAL INFORMATION, REFER TO CARLISLE'S THERMOSET DETAIL [U-5A](#) FOR EPDM AND THERMOPLASTIC DETAIL [U-5A](#) FOR TPO/PVC.
3. SELF-ADHERING EPDM CURB WRAP MAY BE SUBSTITUTED AS FLASHING ON EPDM ROOFS.

	CURB BASE FLASHING – NEW CONSTRUCTION AND RE-ROOF (RECOVER)		DETAIL NO.
	MAXIMUM WARRANTY: 20 YEARS		V-5.1

© 2023 Carlisle SynTec a division of Carlisle Construction Materials Incorporated

VacuSeal Vent Secured Roofing System

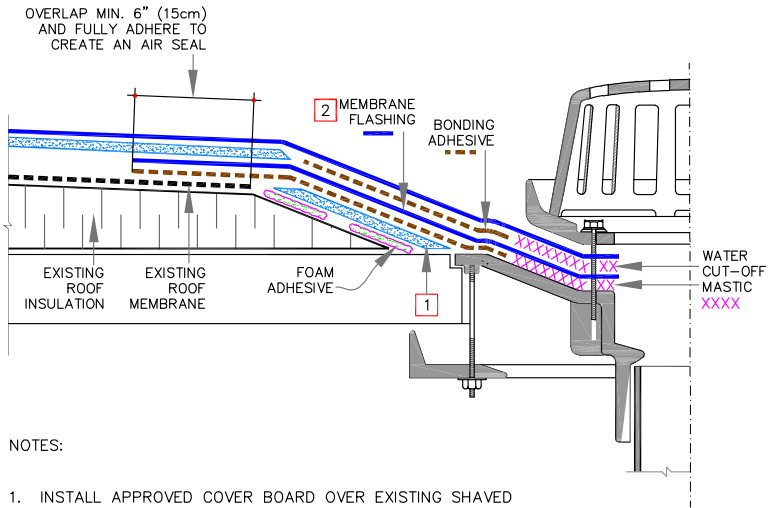

NOTES:

1. INSTALL APPROVED COVER BOARD OVER EXISTING SHAVED INSULATION. CREATE A PROPER SMOOTH SUMP. SET IN FOAM ADHESIVE.
2. FULLY ADHERE MEMBRANE FLASHING TO ACHIEVE AIRTIGHT CONDITION BETWEEN DRAIN AND EXISTING ROOF MEMBRANE. WHERE THERE IS EXISTING ROOF VAPOR BARRIER, CUT IT BACK, IN ORDER TO PROPERLY AIR SEAL.
3. FOR ADDITIONAL INFORMATION, REFER TO CARLISLE'S THERMOSET DETAIL [U-6](#) FOR EPDM AND THERMOPLASTIC DETAIL [U-6](#) FOR TPO/PVC.

	ROOF DRAIN: RE-ROOF (RECOVER)		DETAIL NO.
	MAXIMUM WARRANTY: 20 YEARS		V-6.1

© 2023 Carlisle SynTec a division of Carlisle Construction Materials Incorporated

VacuSeal Vent Secured Roofing System

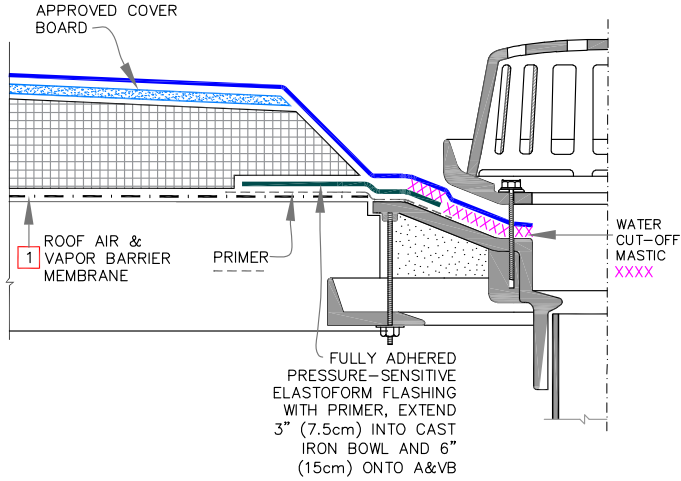

NOTES:

1. PROJECTS WITH STEEL DECKS, DIRECTLY ADHERE VapAir Seal MD. USE VapAir Seal 725TR ON CONCRETE, WOOD DECKS OR DECKS WITH APPROVED COVER BOARDS.
2. FOR ADDITIONAL INFORMATION, REFER TO CARLISLE'S THERMOSET DETAIL [U-6](#) FOR EPDM AND THERMOPLASTIC DETAIL [U-6](#) FOR TPO/PVC.

	ROOF DRAIN: NEW CONSTRUCTION		DETAIL NO.
	MAXIMUM WARRANTY: 20 YEARS		V-6.2

© 2023 Carlisle SynTec a division of Carlisle Construction Materials Incorporated

VacuSeal Vent Secured Roofing System

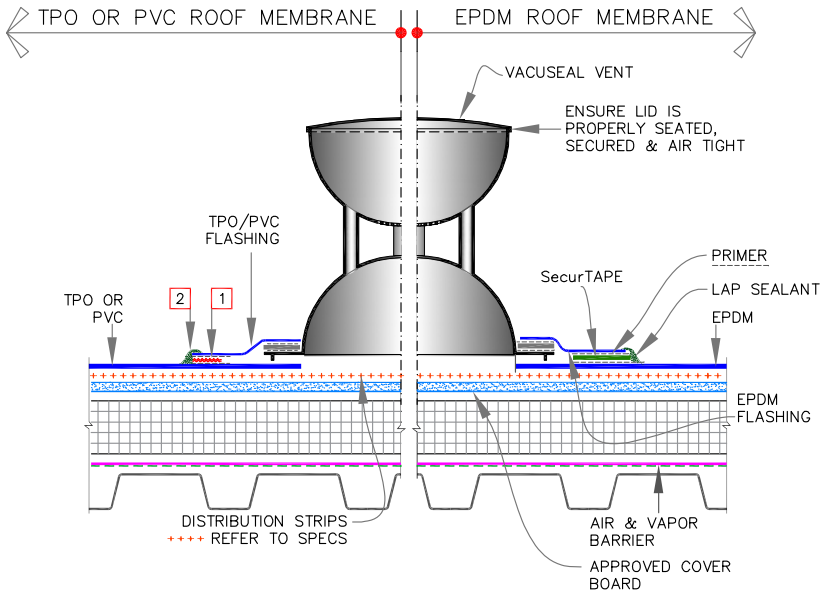

NOTES:

1. HOT AIR WELD, MIN. 1-1/2" (4cm).
2. APPROXIMATELY 1/8" (0.5cm) DIAMETER BEAD OF CUT-EDGE SEALANT IS REQUIRED ON CUT EDGES OF REINFORCED TPO MEMBRANE.

	VACUSEAL VENT WITH PRE-APPLIED SKIRT FLASHING		DETAIL NO. V-8.0
	MAXIMUM WARRANTY: 20 YEARS		

© 2023 Carlisle SynTec a division of Carlisle Construction Materials Incorporated

VacuSeal Vent Secured Roofing System

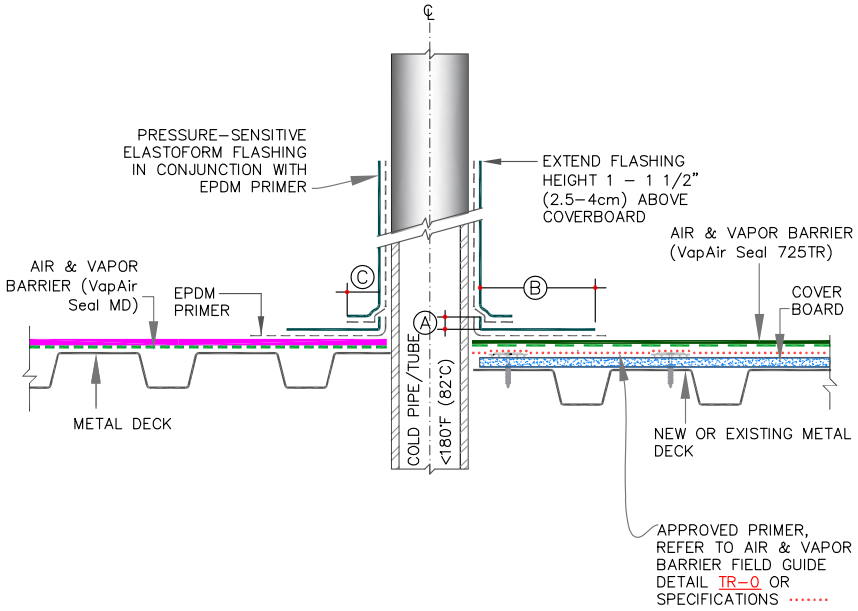

NOTE:

- FOR ADDITIONAL INFORMATION, REFER TO CARLISLE THERMOSET DETAIL [U-8B](#).

DIMENSIONS	cm	
(A) 1/2"	1.5	MIN.
(B) 5.5"	14	MIN.
(C) 1"	2.5	MIN.



PIPE/STRUCTURAL STEEL TUBE THROUGH METAL DECK

MAXIMUM WARRANTY: 20 YEARS



DETAIL NO.

V-8.1

VacuSeal Vent Secured Roofing System

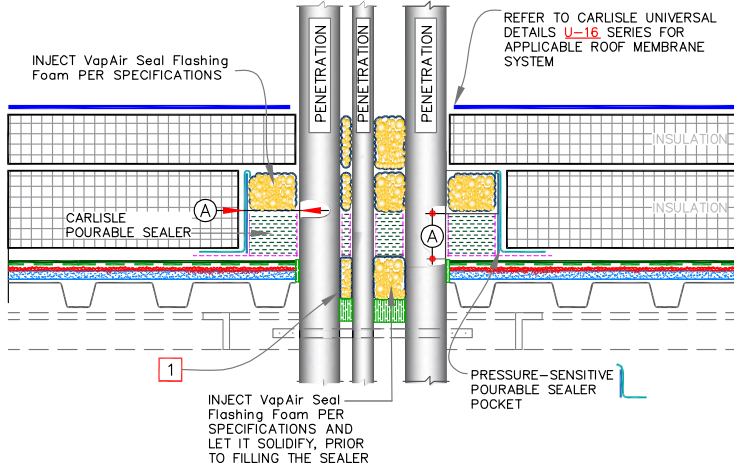

REFER TO CARLISLE UNIVERSAL DETAILS U-16 SERIES FOR APPLICABLE ROOF MEMBRANE SYSTEM

INJECT VapAir Seal Flashing Foam PER SPECIFICATIONS

CARLISLE POURABLE SEALER

INSULATION

INSULATION

1

INJECT VapAir Seal Flashing Foam PER SPECIFICATIONS AND LET IT SOLIDIFY, PRIOR TO FILLING THE SEALER

PRESSURE-SENSITIVE POURABLE SEALER POCKET

DIMENSIONS	cm	
Ⓐ	1/2"	1.5 TO
	1"	2.5

NOTES:

1. THE MAXIMUM ALLOWABLE SURFACE TEMPERATURE OF THE PENETRATION SHALL NOT EXCEED 180° F (82° C).
2. PENETRATIONS, AIR & VAPOR BARRIER, FLASHING AND METAL (INSIDE POCKET) MUST BE PRIMED WITH EPDM PRIMER PRIOR TO APPLYING POURABLE SEALER. DO NOT PRIME THE BLUE PLASTIC SUPPORT STRIP.
3. POURABLE SEALER MUST CONTACT PRIMED PRESSURE-SENSITIVE ELASTOFORM FLASHING AND AIR & VAPOR BARRIER.
4. PIPE CLUSTERS MUST HAVE MINIMUM 1" (2.5cm) CLEARANCE BETWEEN PENETRATIONS.

	MULTIPLE PENETRATIONS THROUGH STEEL DECK - NEW CONSTRUCTION		DETAIL NO.
	MAXIMUM WARRANTY: 20 YEARS		V-8.2

© 2023 Carlisle SynTec a division of Carlisle Construction Materials Incorporated

VacuSeal Vent Secured Roofing System

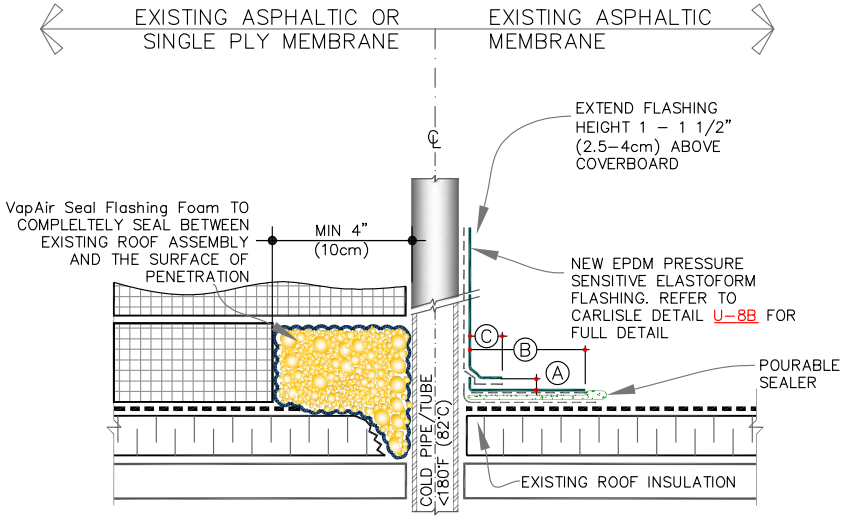

DIMENSIONS	cm	
(A)	1/2"	1.5 MIN.
(B)	5.5"	14 MIN.
(C)	1"	2.5 MIN.

	SINGLE PENETRATION THROUGH EXISTING ROOF ASSEMBLY		DETAIL NO.
	MAXIMUM WARRANTY: 20 YEARS		V-8.3



© 2023 Carlisle SynTec a division of Carlisle Construction Materials Incorporated

VacuSeal Vent Secured Roofing System

NOTES:

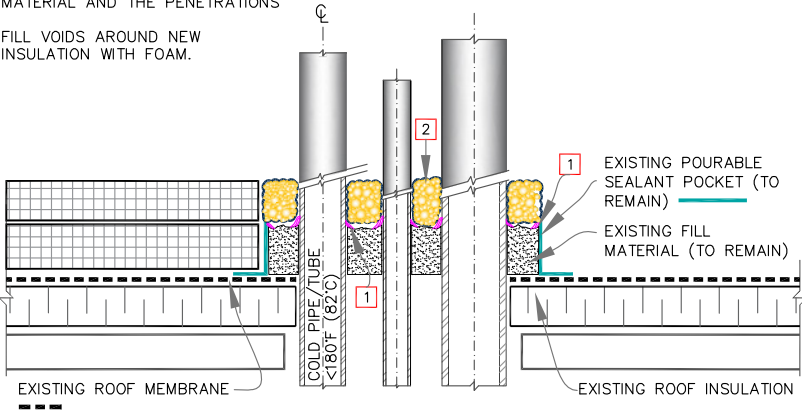
1. APPLY NEW SEALANT AT ALL CRACKED AND BREACHED AREAS OF POURABLE SEALERS. ENSURE A PROPER BOND BETWEEN EXISTING MATERIAL AND THE PENETRATIONS
2. FILL VOIDS AROUND NEW INSULATION WITH FOAM.



	CLUSTER OF PENETRATIONS THROUGH EXISTING ROOF ASSEMBLY		DETAIL NO.
	MAXIMUM WARRANTY: 20 YEARS		V-8.4

© 2023 Carlisle SynTec a division of Carlisle Construction Materials Incorporated

VacuSeal Vent Secured Roofing System

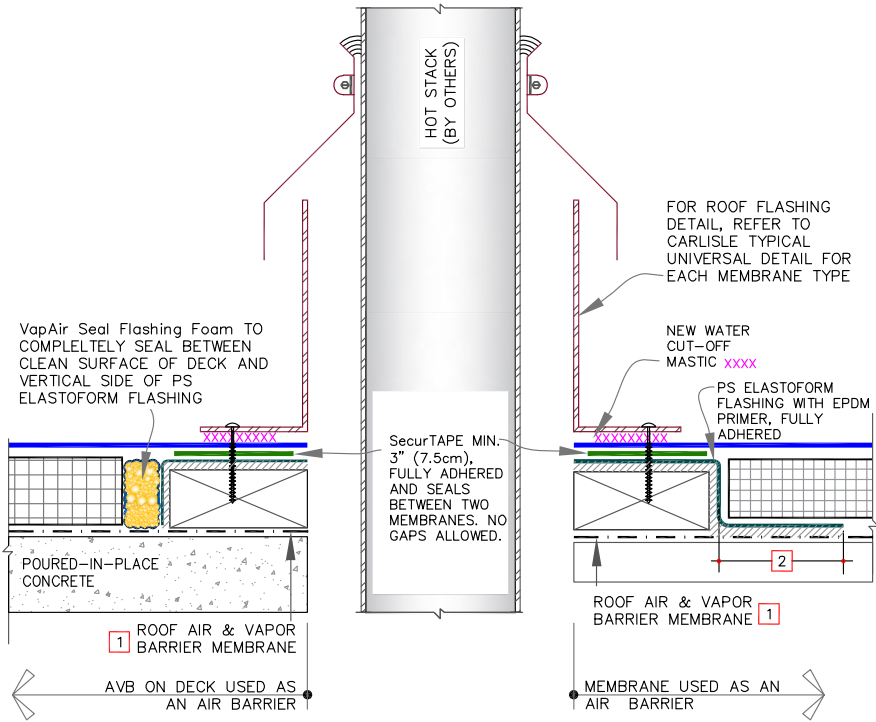

NOTES:

1. ON STEEL DECKS DIRECTLY ADHERE VapAir Seal MD. USE VapAir Seal 725TR ON CONCRETE & WOOD DECKS OR DECKS WITH APPROVED COVER BOARDS.
2. OVERLAP MIN. 6" (15cm) AND FULLY ADHERE TO CREATE AN AIR SEAL.

	HOT STACK AIR FLASHING – OPTION A		DETAIL NO.
	MAXIMUM WARRANTY: 20 YEARS		V-8.5A

© 2023 Carlisle SynTec a division of Carlisle Construction Materials Incorporated

VacuSeal Vent Secured Roofing System

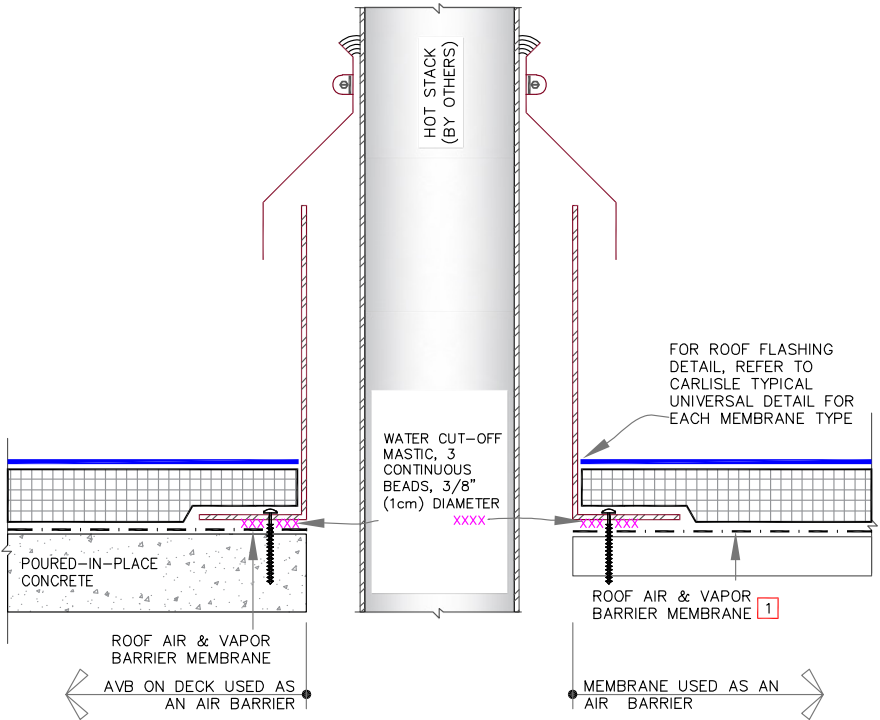

NOTES:

1. ON STEEL DECKS DIRECTLY ADHERE VapAir Seal MD. USE VapAir Seal 725TR ON CONCRETE & WOOD DECKS OR DECKS WITH APPROVED COVER BOARDS.

	HOT STACK AIR FLASHING – OPTION B		DETAIL NO.
	MAXIMUM WARRANTY: 20 YEARS		V-8.5B

© 2023 Carlisle SynTec a division of Carlisle Construction Materials Incorporated

VacuSeal Vent Secured Roofing System

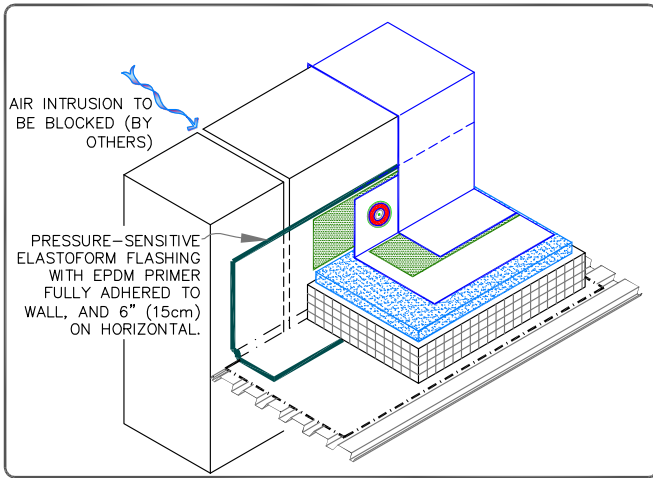
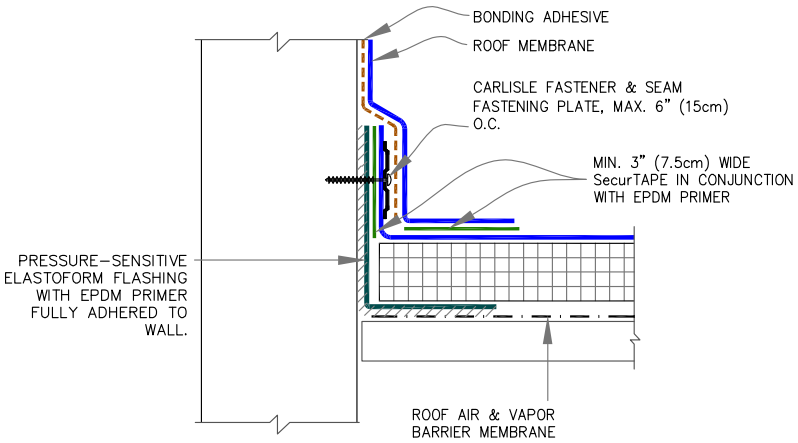

	PARAPET WITH MEMBRANE AIR BARRIER		DETAIL NO.
	MAXIMUM WARRANTY: 20 YEARS		V-12.1

© 2023 Carlisle SynTec a division of Carlisle Construction Materials Incorporated

VacuSeal Vent Secured Roofing System

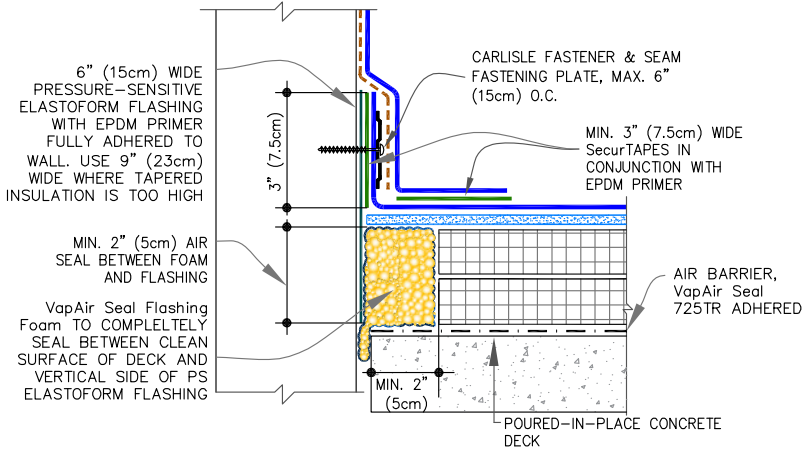

(A) OPTION: AIR SEALING WITH FOAM

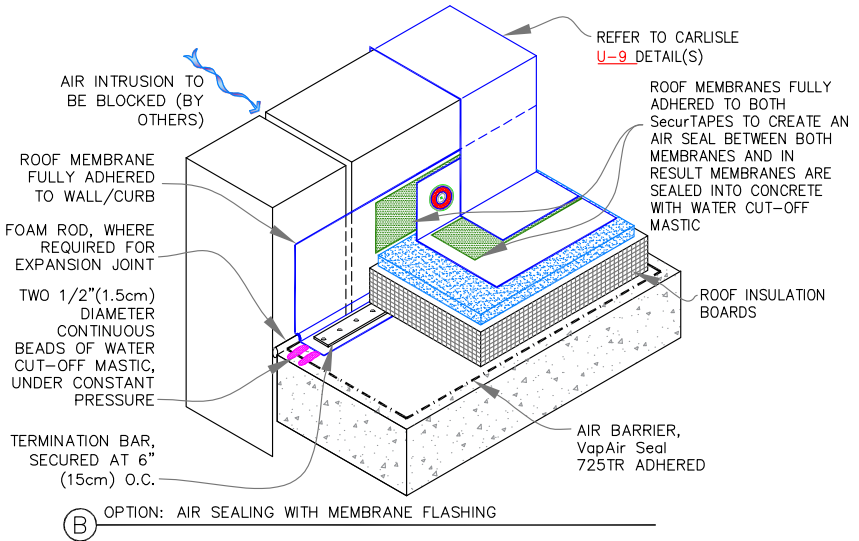

(B) OPTION: AIR SEALING WITH MEMBRANE FLASHING

	PARAPET / CURB: CONCRETE/LIGHTWEIGHT CONCRETE WITH DECK LEVEL AIR/VAPOR BARRIER		DETAIL NO.
	MAXIMUM WARRANTY: 20 YEARS		V-12.2

(C) 2023 Carlisle SynTec a division of Carlisle Construction Materials Incorporated

VacuSeal Vent Secured Roofing System

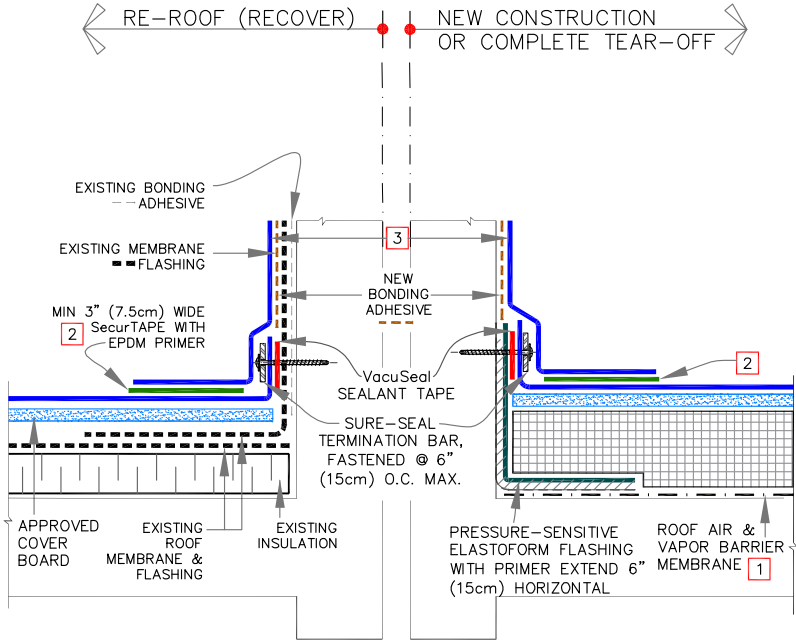

NOTES:

1. ON STEEL DECKS DIRECTLY ADHERE VapAir Seal MD. USE VapAir Seal 725TR ON CONCRETE & WOOD DECKS OR DECKS WITH APPROVED COVER BOARDS.
2. FOR ADDITIONAL INFORMATION, REFER TO CARLISLE'S THERMOSET DETAIL [U-5A](#) FOR EPDM AND THERMOPLASTIC DETAIL [U-5A](#) FOR TPO/PVC.
3. SELF-ADHERING EPDM CURB WRAP MAY BE SUBSTITUTED AS FLASHING ON EPDM ROOFS.

	PARAPET OR WALL – NEW CONSTRUCTION AND RE-ROOF (RECOVER)		DETAIL NO.
	MAXIMUM WARRANTY: 20 YEARS		V-12.3

© 2023 Carlisle SynTec a division of Carlisle Construction Materials Incorporated

800-479-6832 • www.carlisesyntec.com

Carlisle, FleeceBACK, Sure-Weld, Sure-Flex, Sure-Seal, Sure-Tough, Sure-White, APEEL, Spectro-Weld, SAT, RL, SecurShield, SecurWeld, SecurEdge, Insulbase, Stormbase, ChannelDry, EcoStorm VSH, HP-X Fastener, Insulfast, InsulLam, LIQUISEAL, Piranha Plate, SecurFast, FAST, HydroBond, UN-TACK, SecurTAPE, CAV-GRIP, VacuSeal, VapAir Seal, and Contour Rib are trademarks of Carlisle. R-Tech is a registered trademark of Insulfoam. SECURROCK is a registered trademark of USG Corporation. Galvalume is a registered trademark of BEIC International, Inc. RhinoBond is a registered trademark of OMG, Inc. IsoWeld is a registered trademark of SFS Intec, Inc. DensDeck is a registered trademark of Georgia-Pacific Gypsum LLC. LEED is a registered trademark of the U.S. Green Building Council.

© 2023 Carlisle. REPRINT CODE: 611463 CST-9994 - "Thermoplastics Field Guide" - 09.06.23